

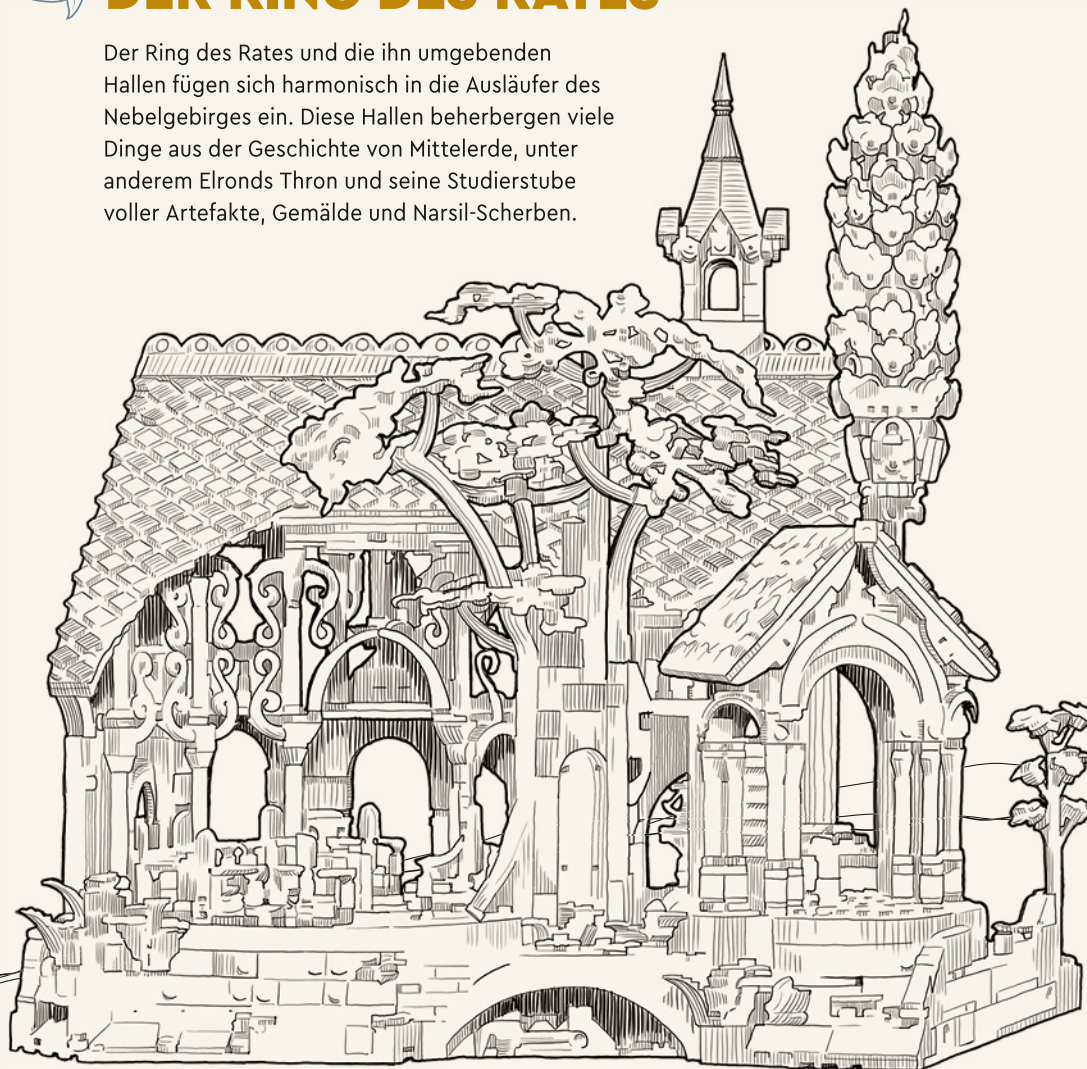

DER RING DES RATES

Der Ring des Rates und die ihn umgebenden Hallen fügen sich harmonisch in die Ausläufer des Nebelgebirges ein. Diese Hallen beherbergen viele Dinge aus der Geschichte von Mittelerde, unter anderem Elronds Thron und seine Studierstube voller Artefakte, Gemälde und Narsil-Scherben.



Boromir hält das neu designte Schwert von Gondor sowie seinen bewährten runden Schild.

BOROMIR



Elrond trägt ein neu designtes Haarteil, das aus zwei Materialien geformt wird, damit die Ohren farblich von den Haaren abgesetzt sind.

ELROND



MERRY UND PIPPIN

Merry und Pippin tragen ihre Reisegewänder sowie Umhänge. Genau wie bei Frodo werden auch die Beine dieser beiden Minifiguren aus zwei Materialien geformt, um ihre nackten Füße in einer anderen Farbe darzustellen.

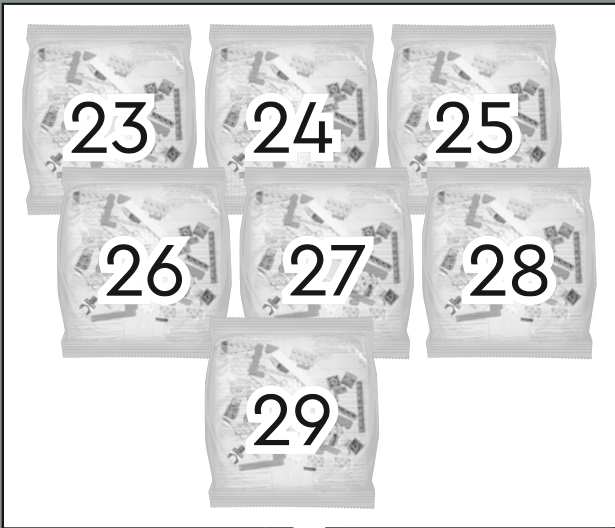

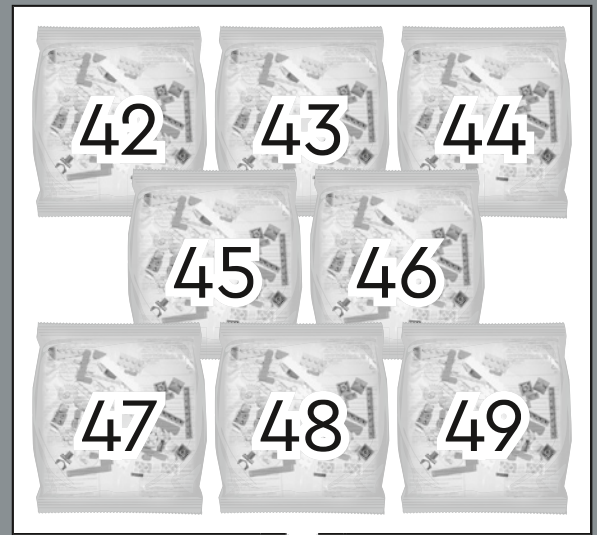

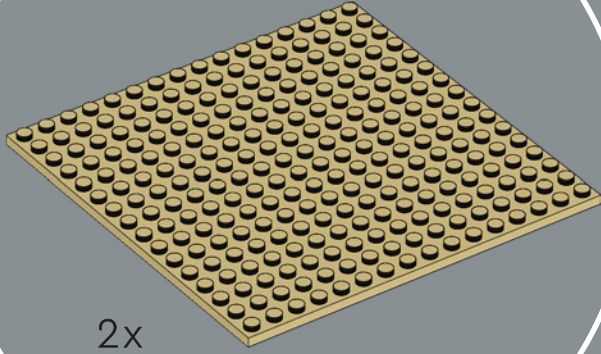
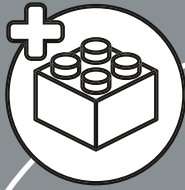

2x



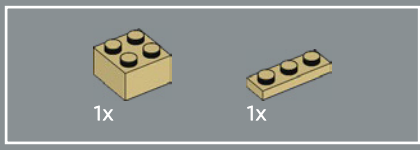

1

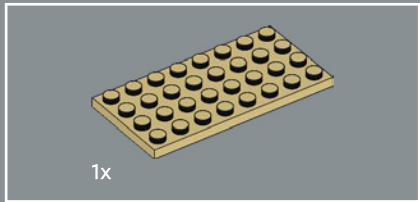
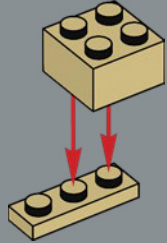

2

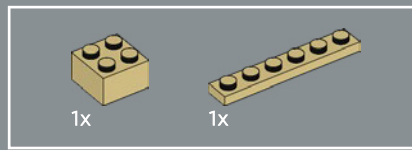
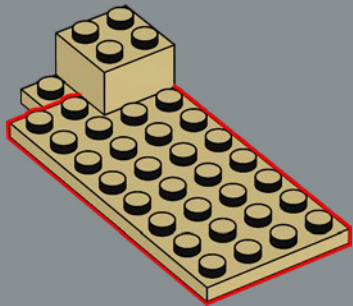

3

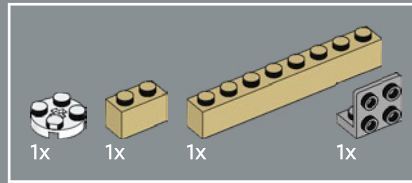
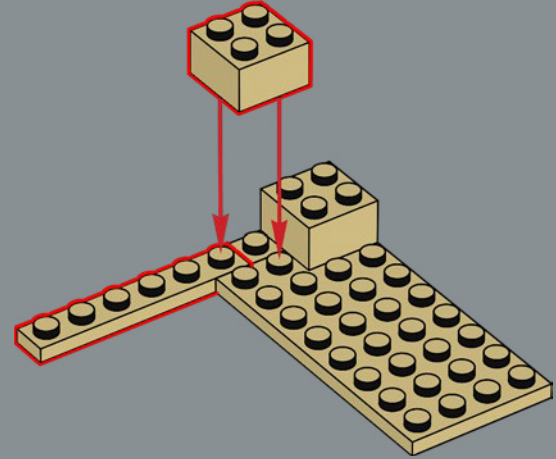

4

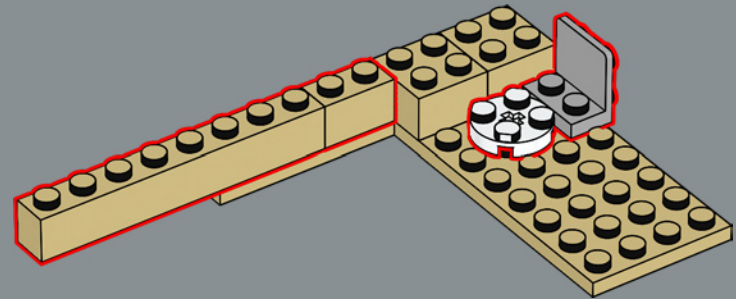

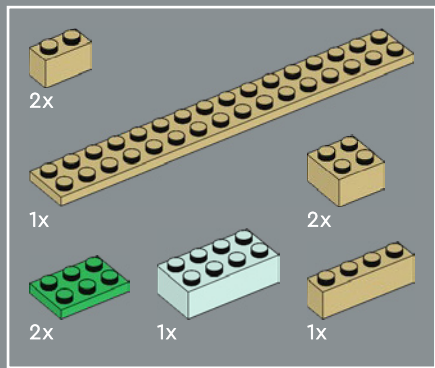

5

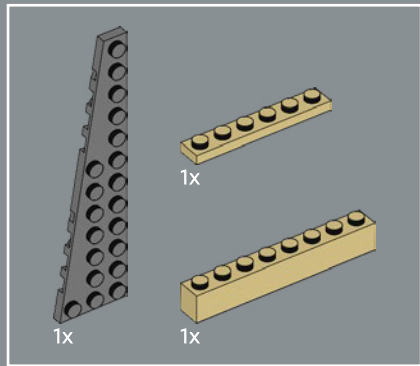
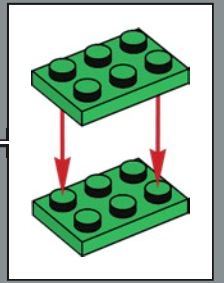
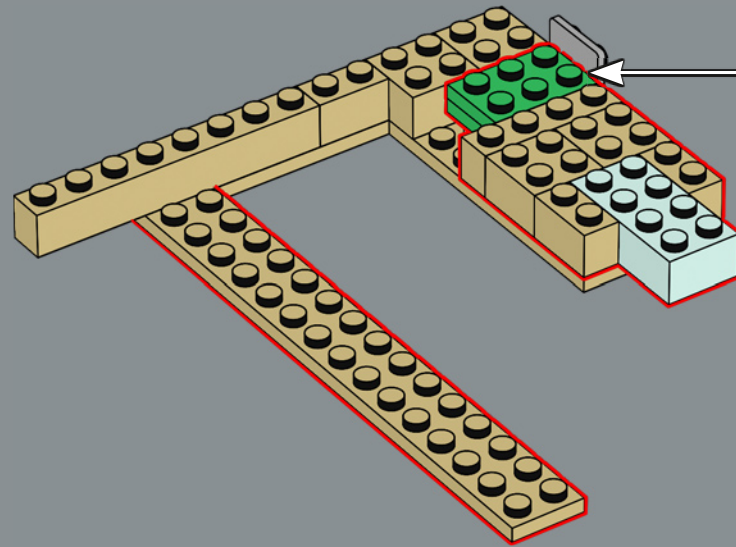

6

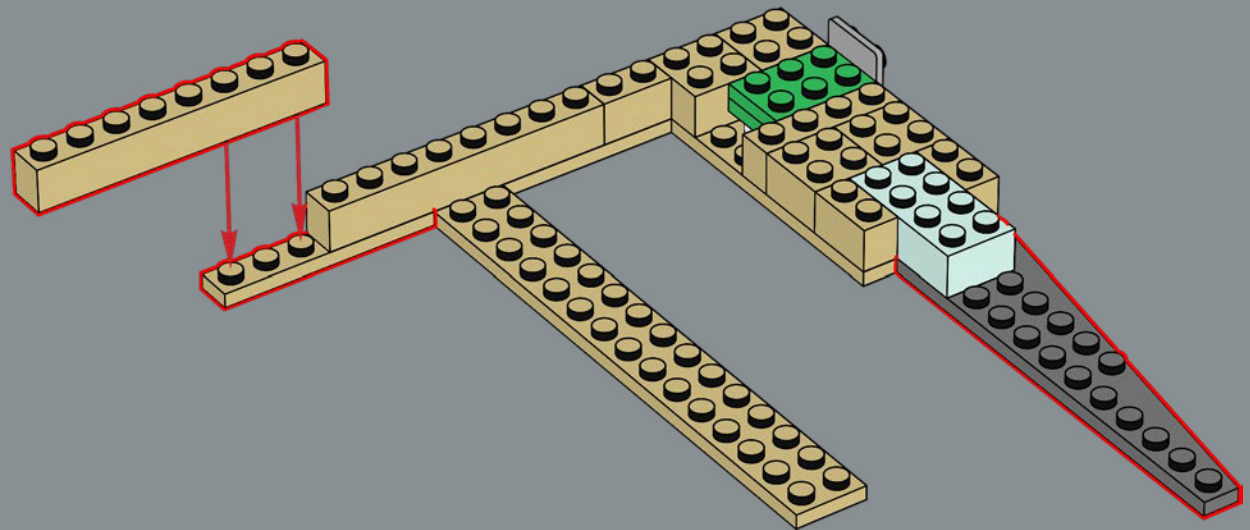

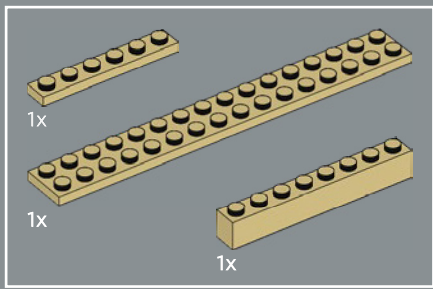

7

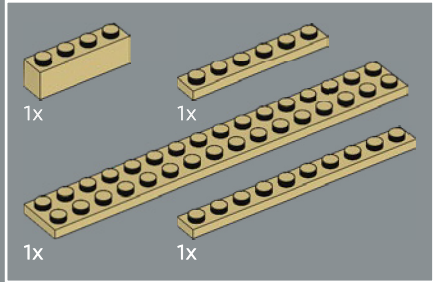
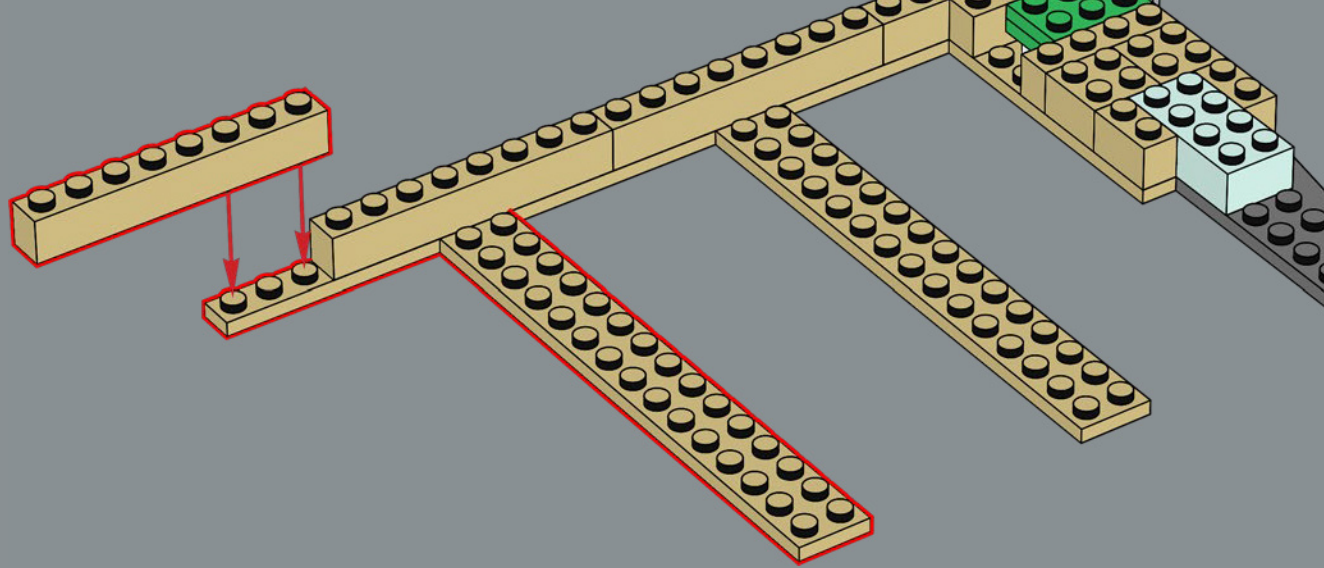

8

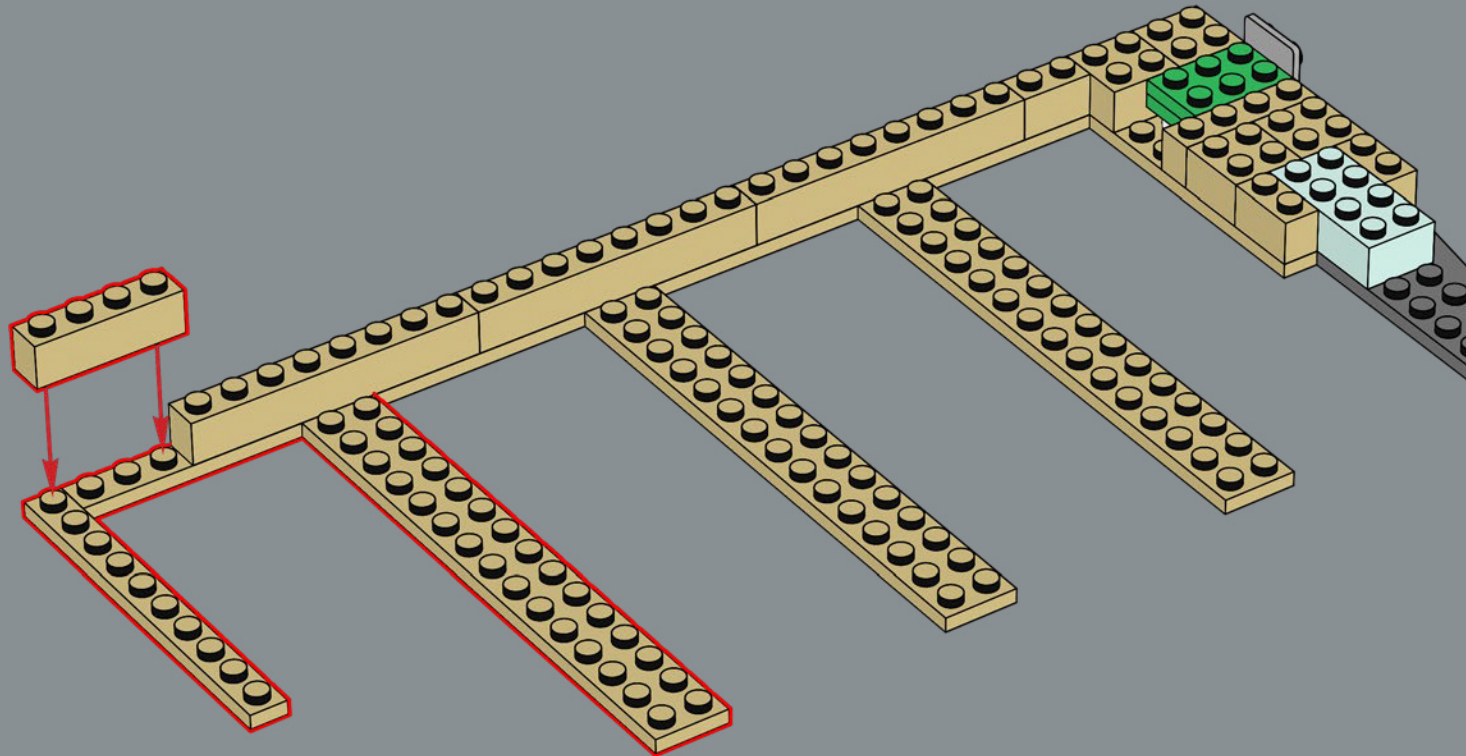

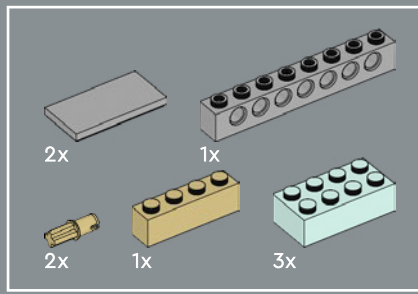

9

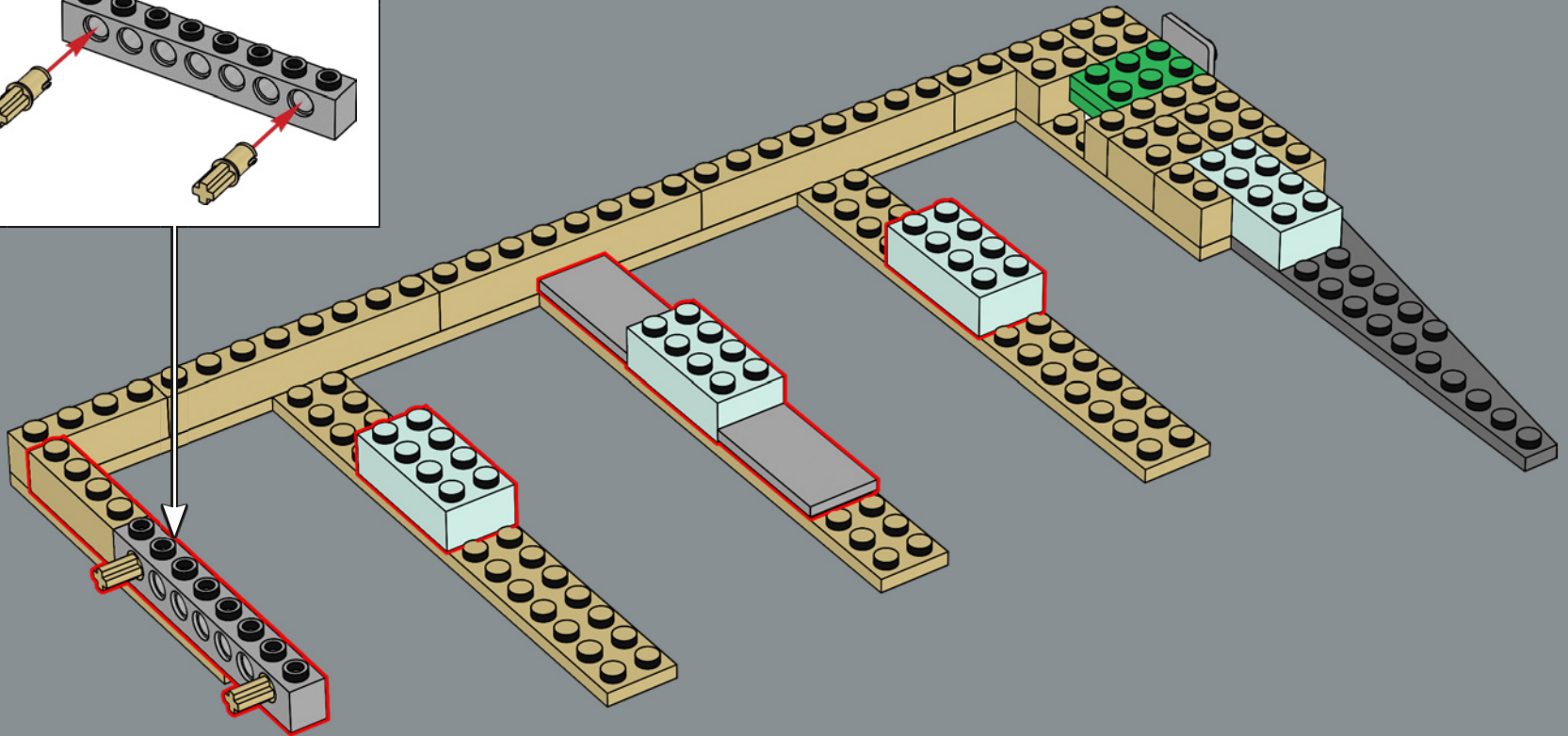
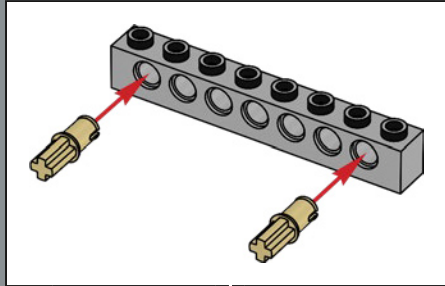

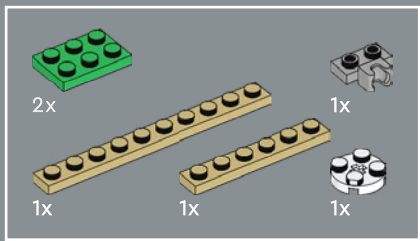

10

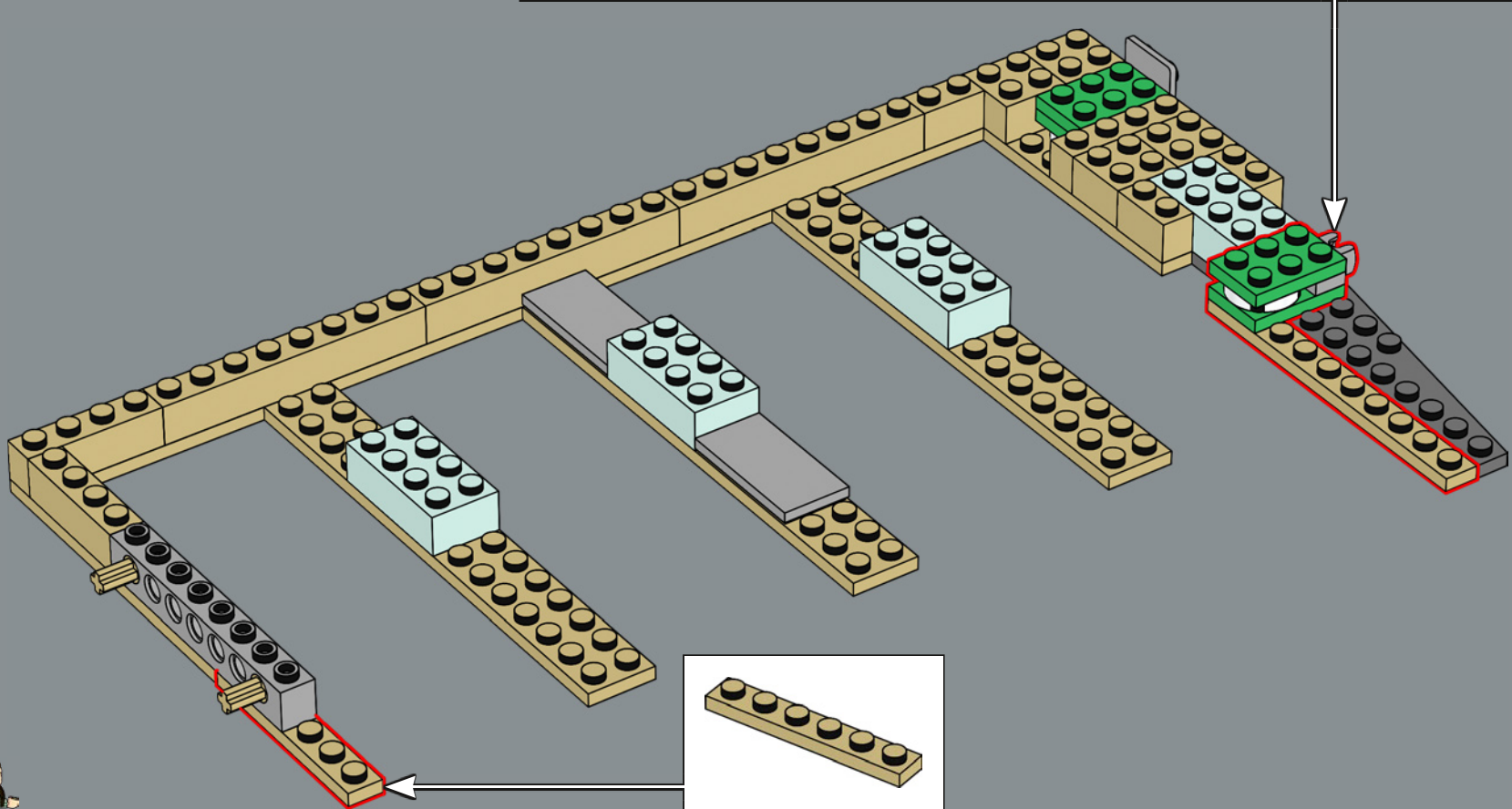
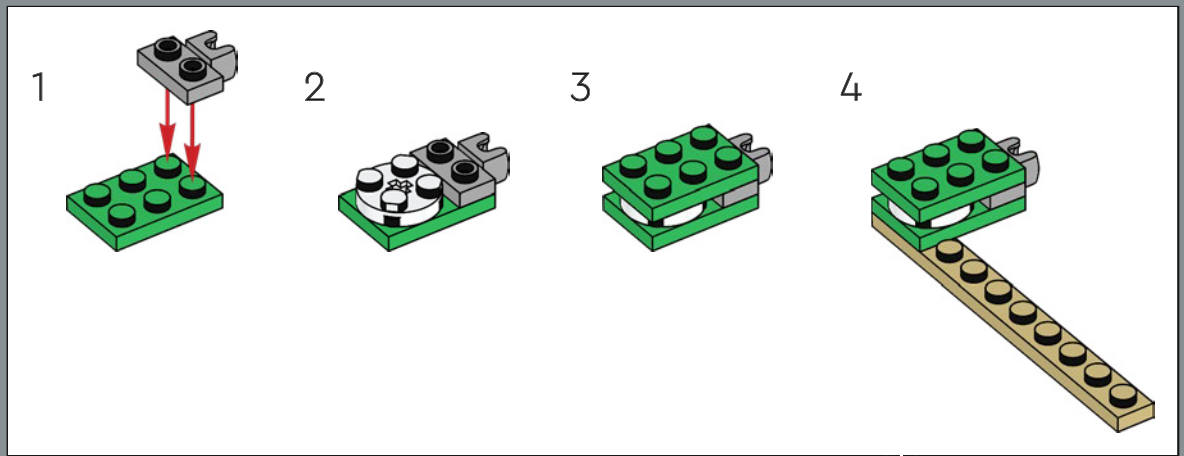

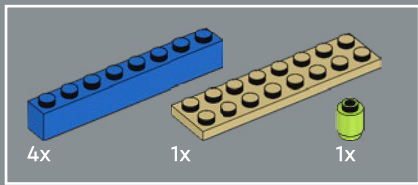

11

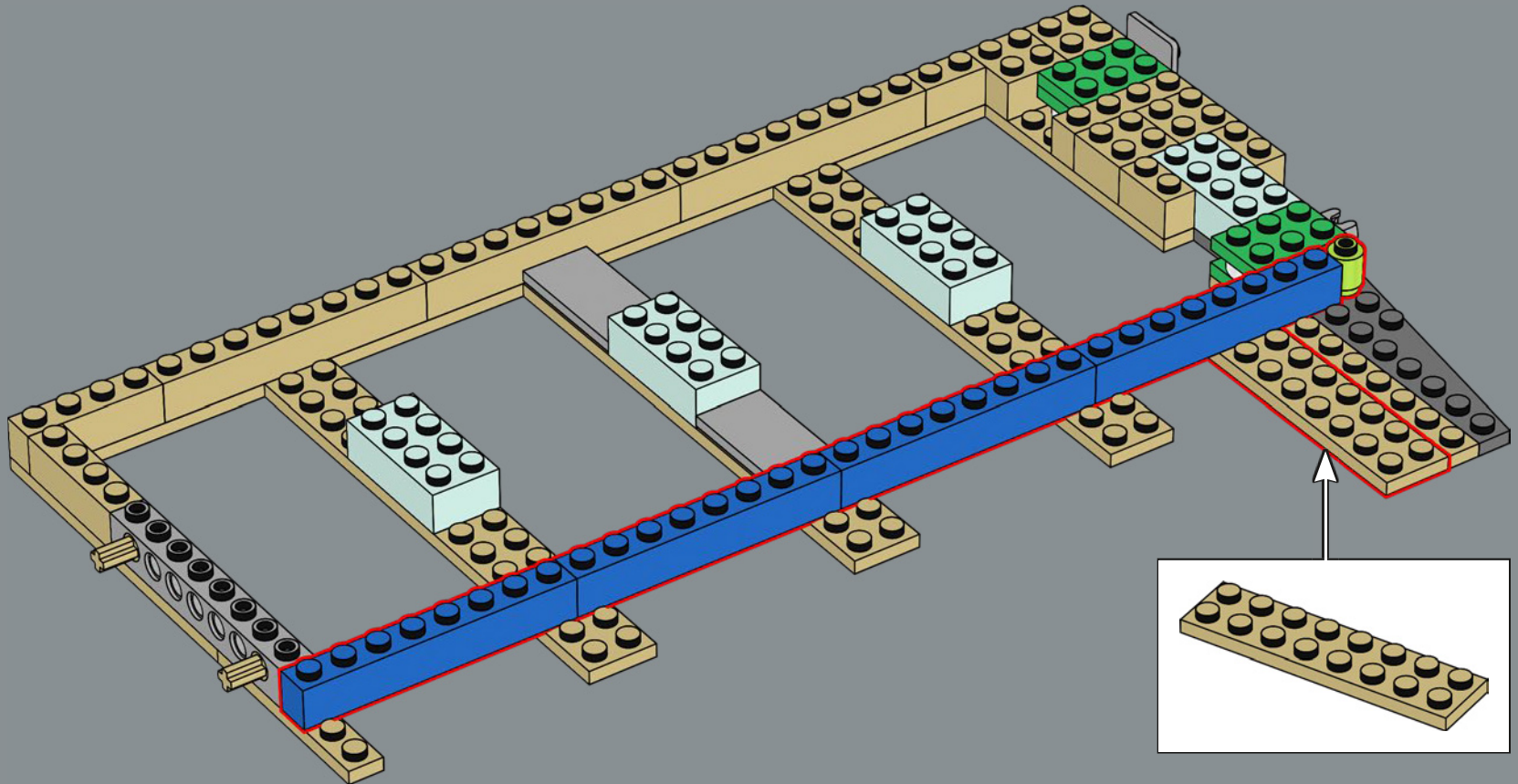

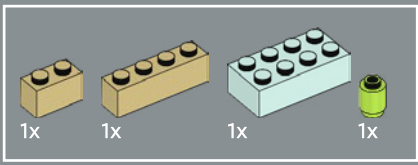

12

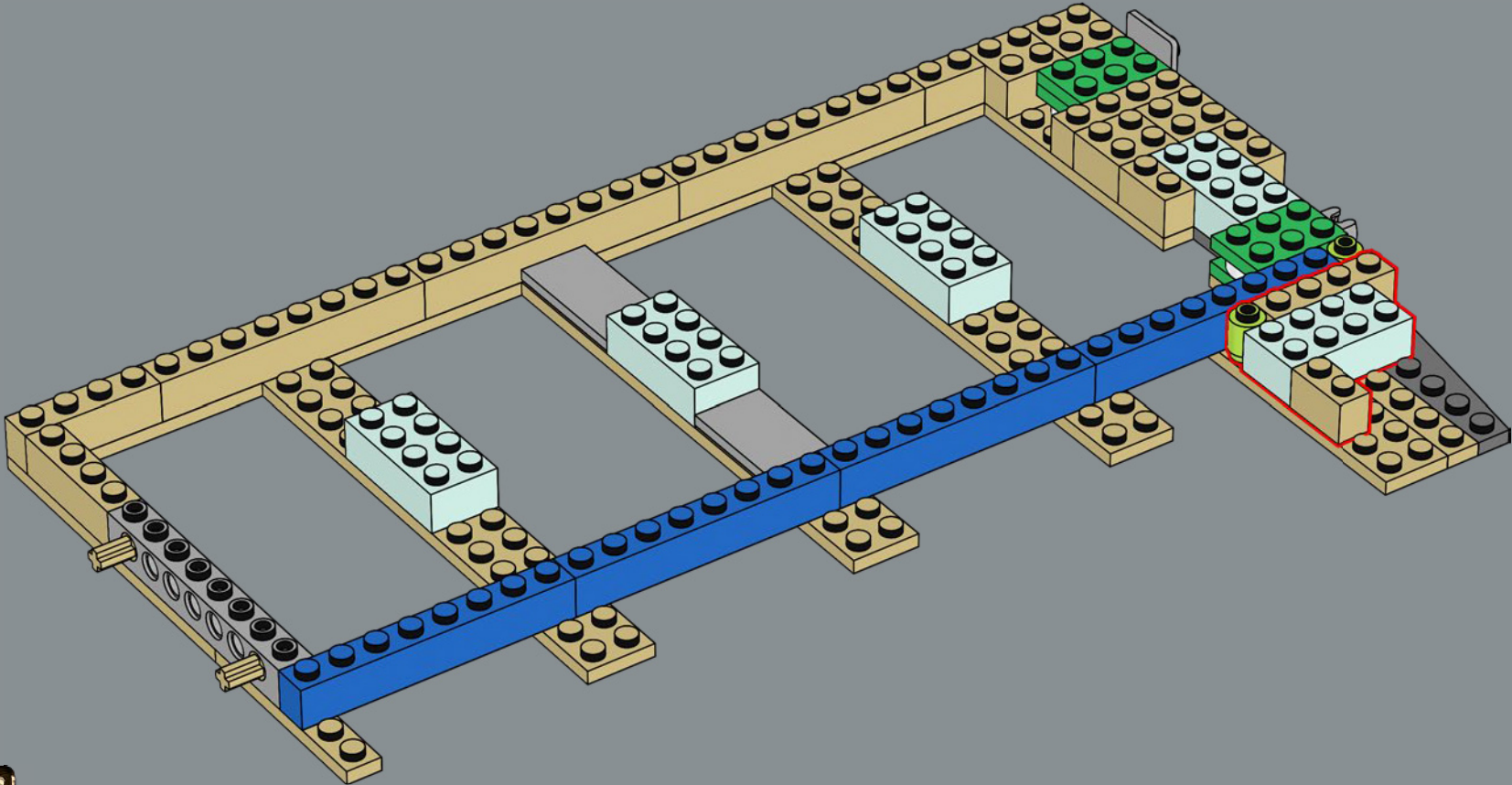

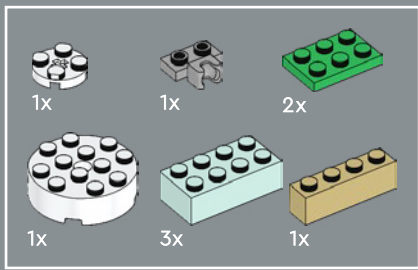

13

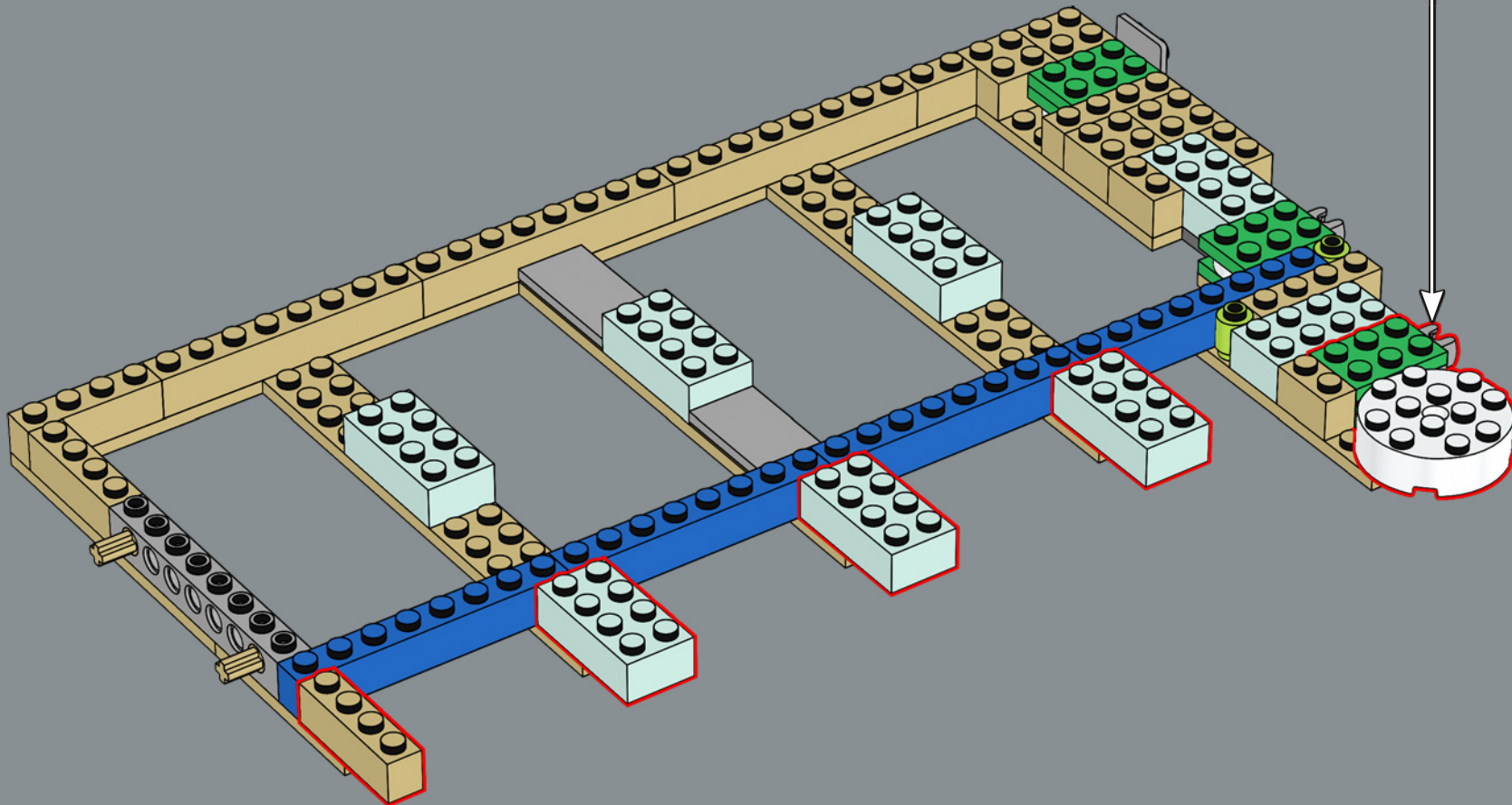
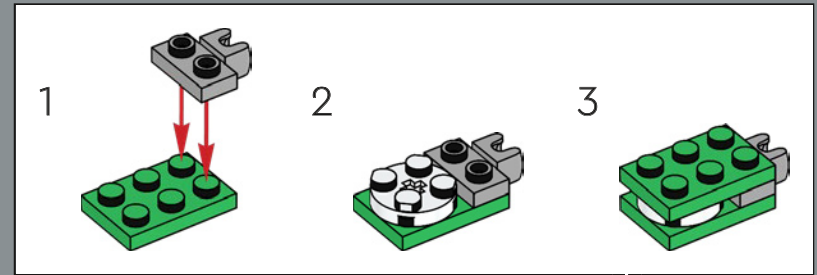

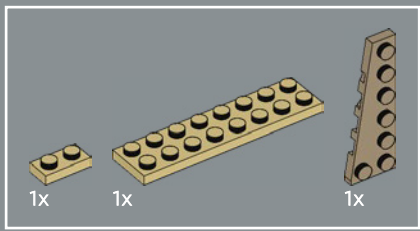

14

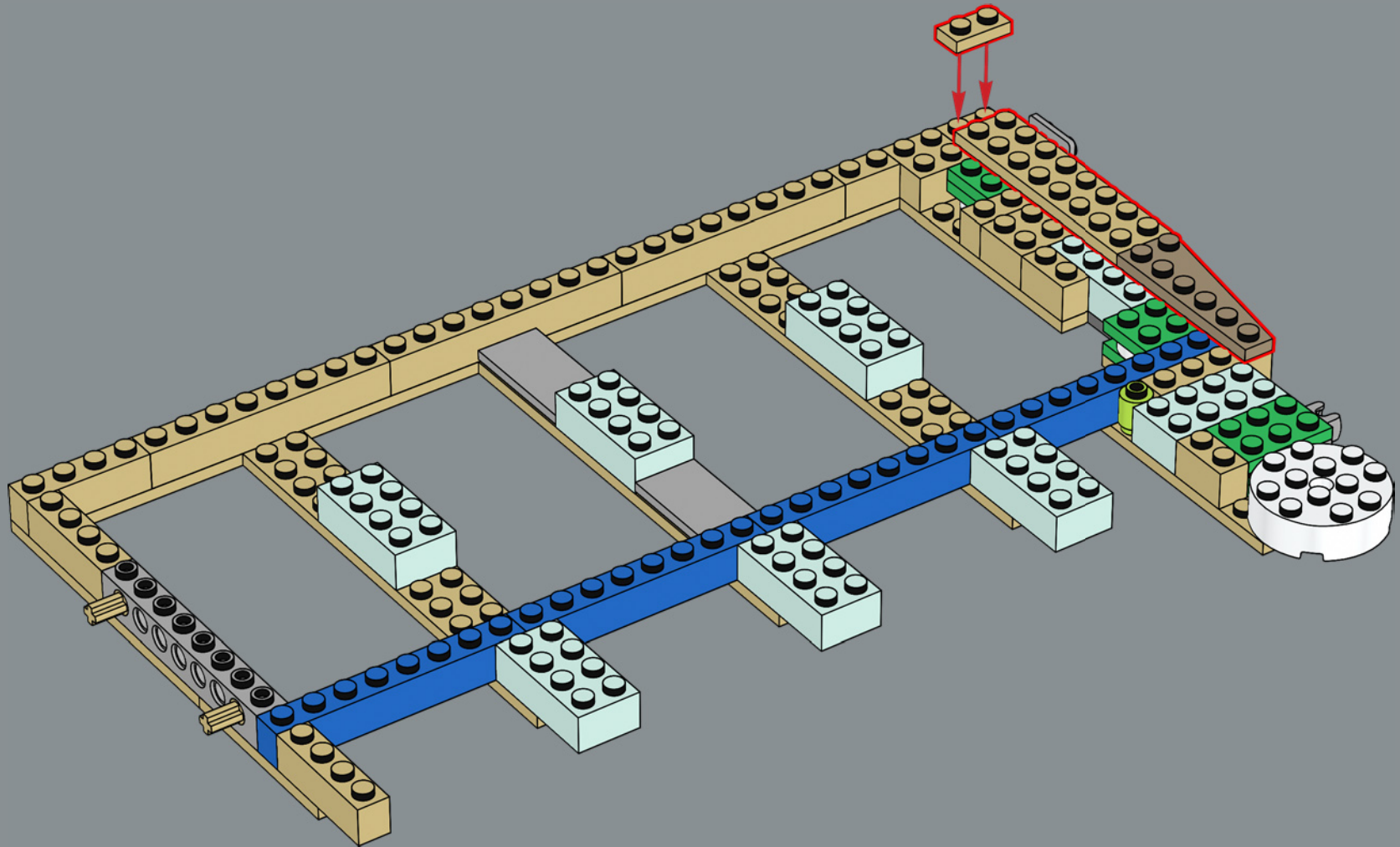

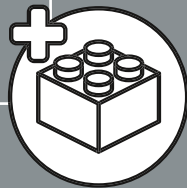
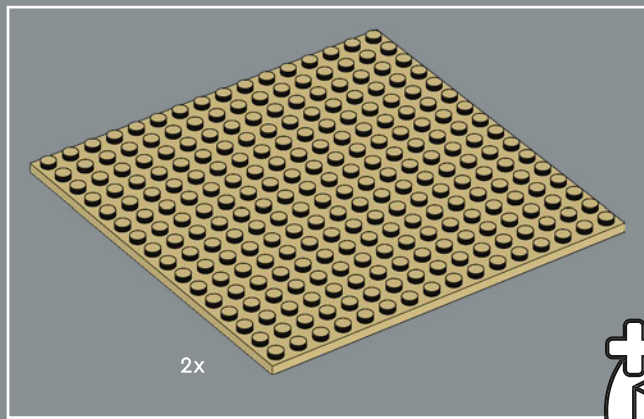

15

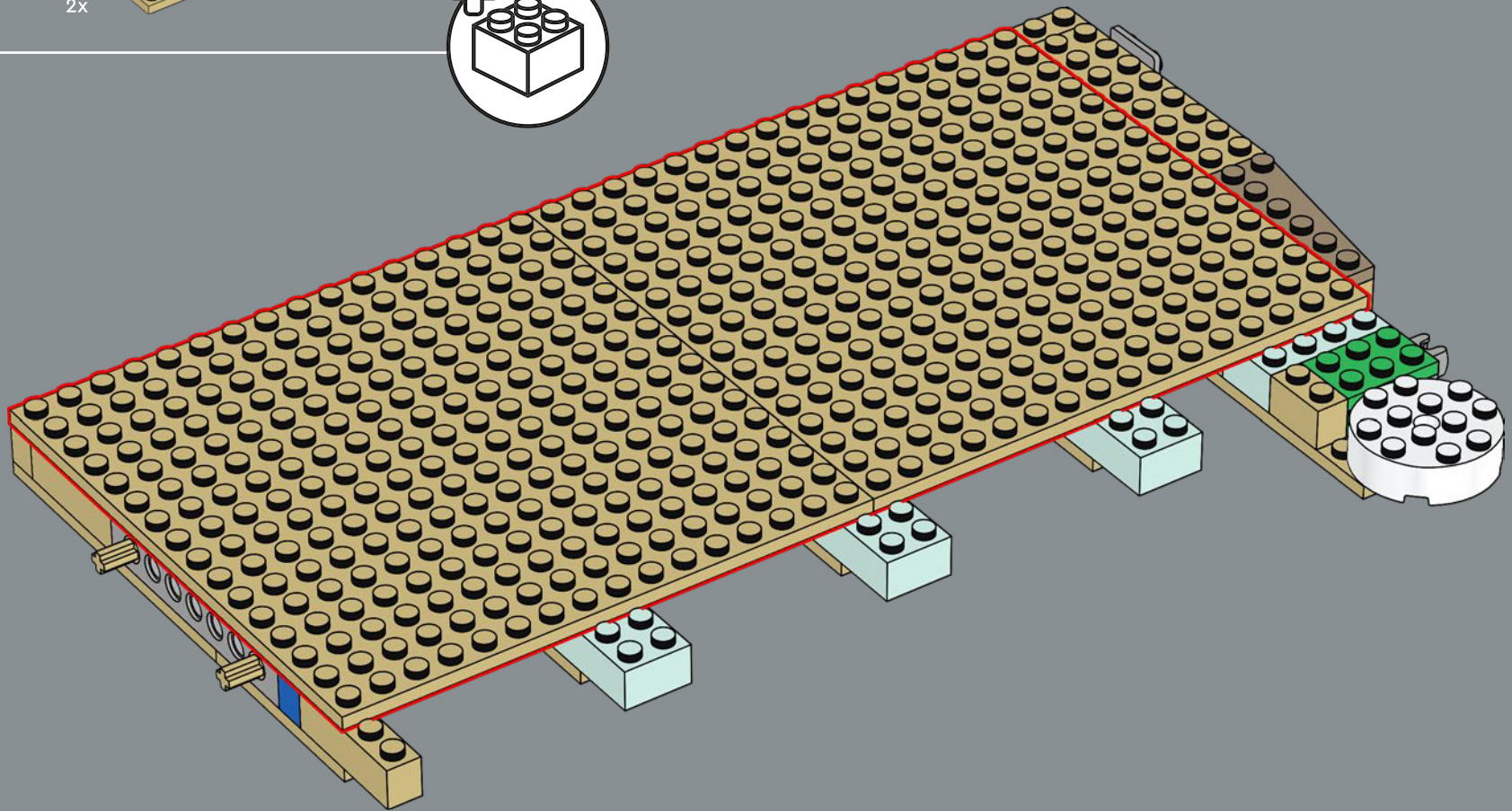

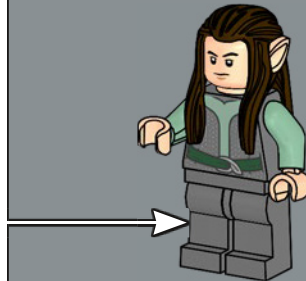
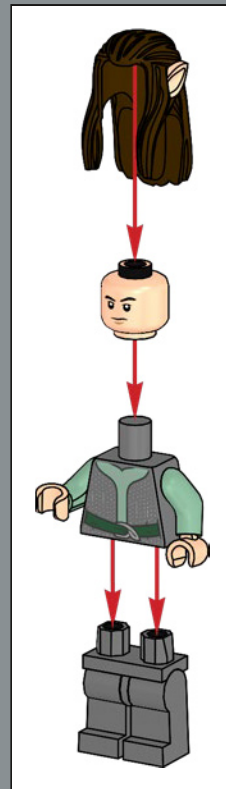

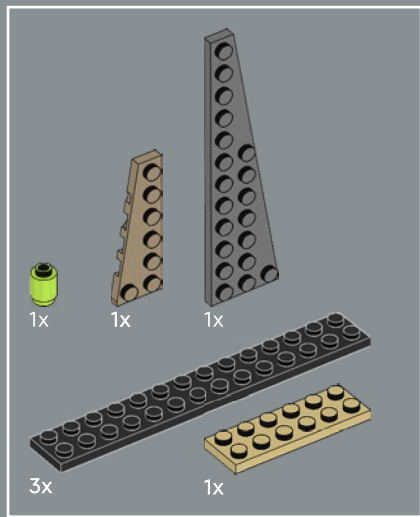

16

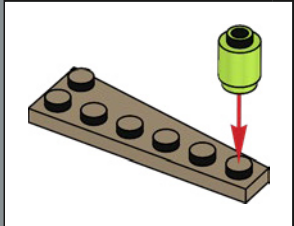
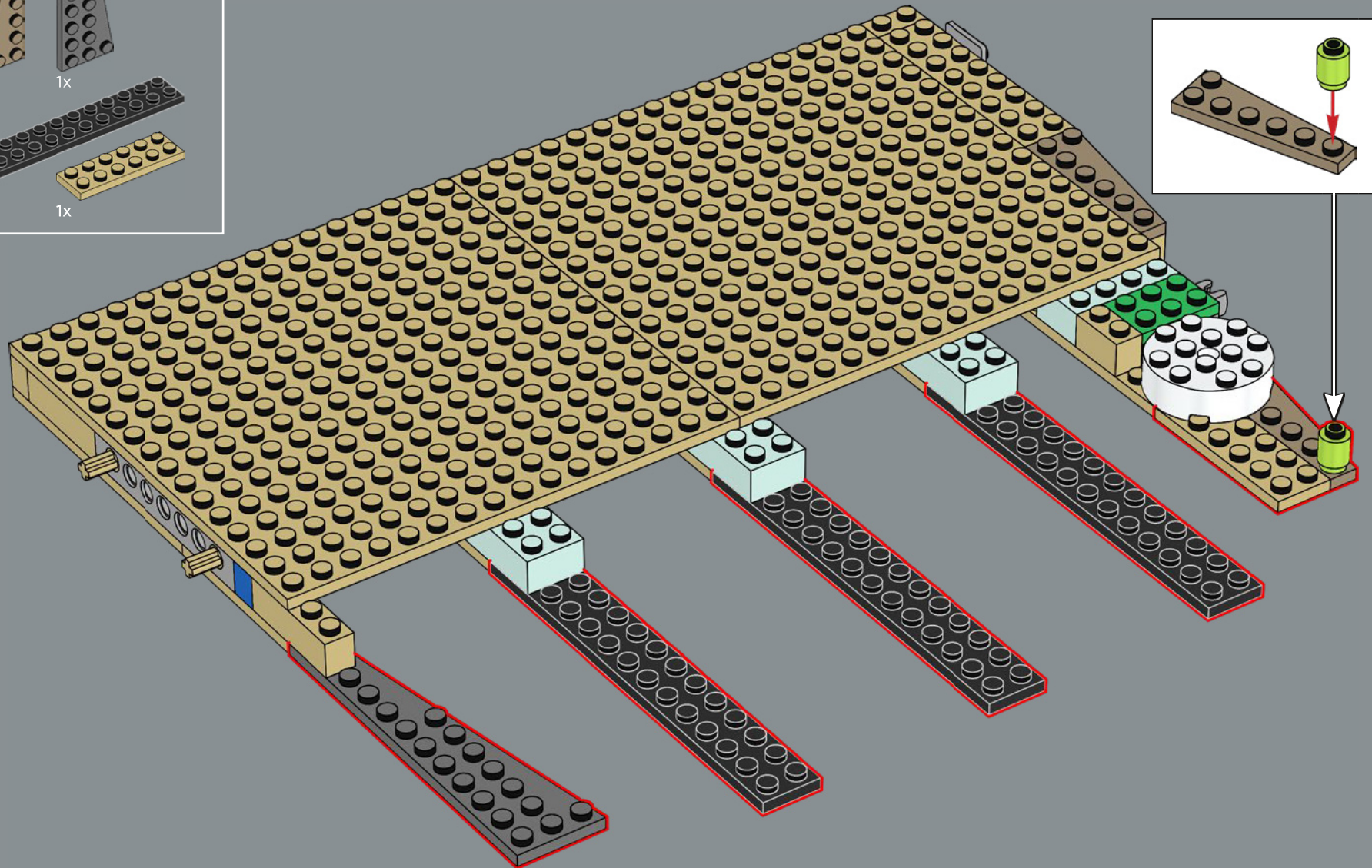

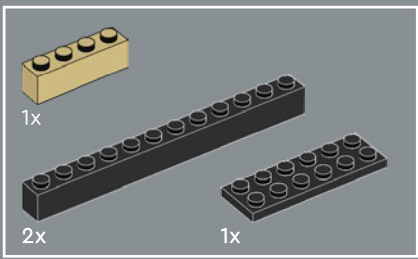

17

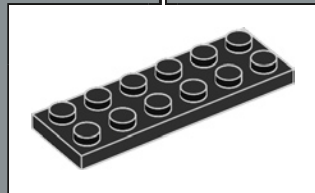
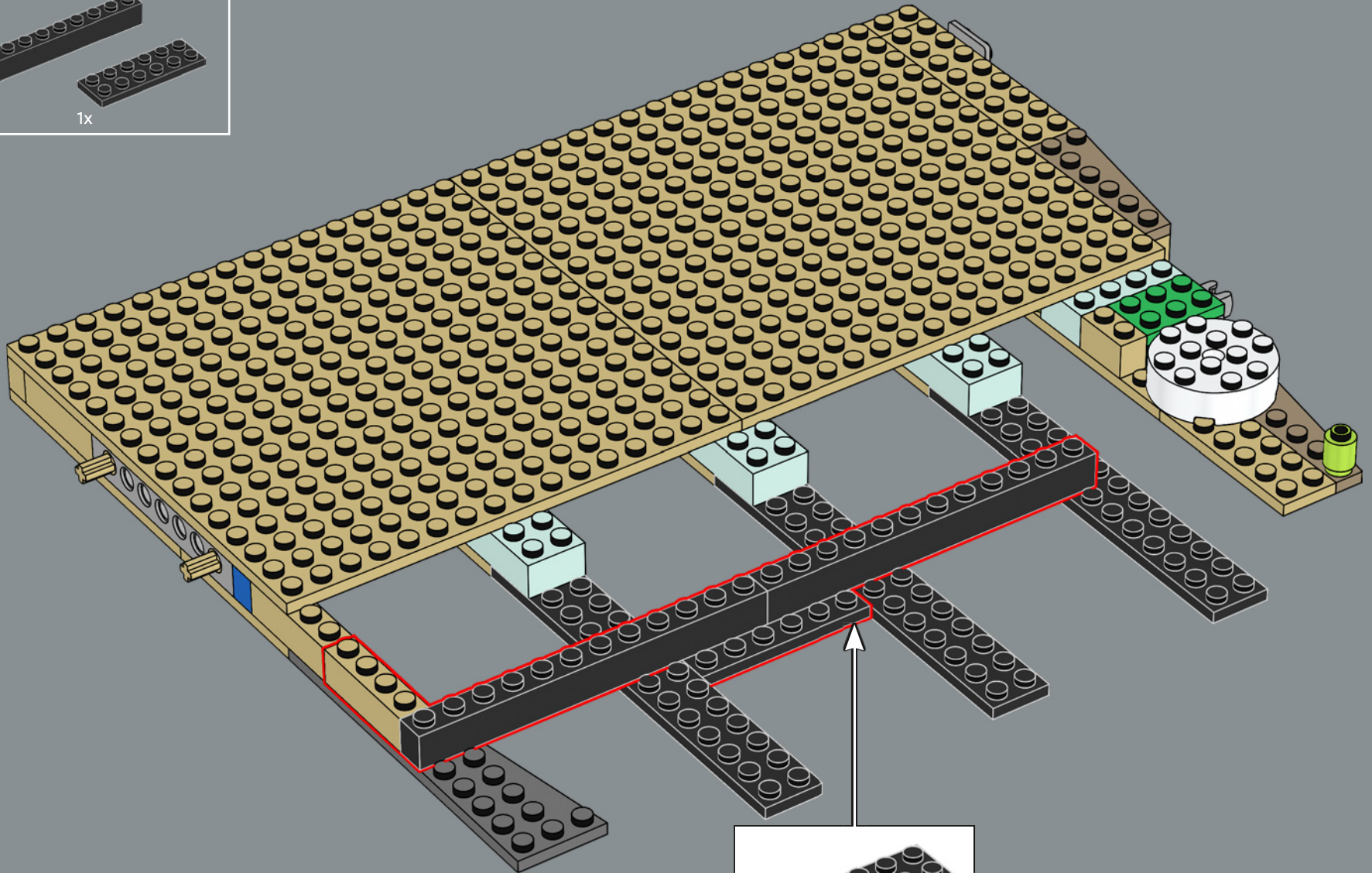

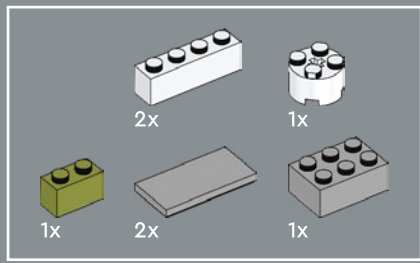

18

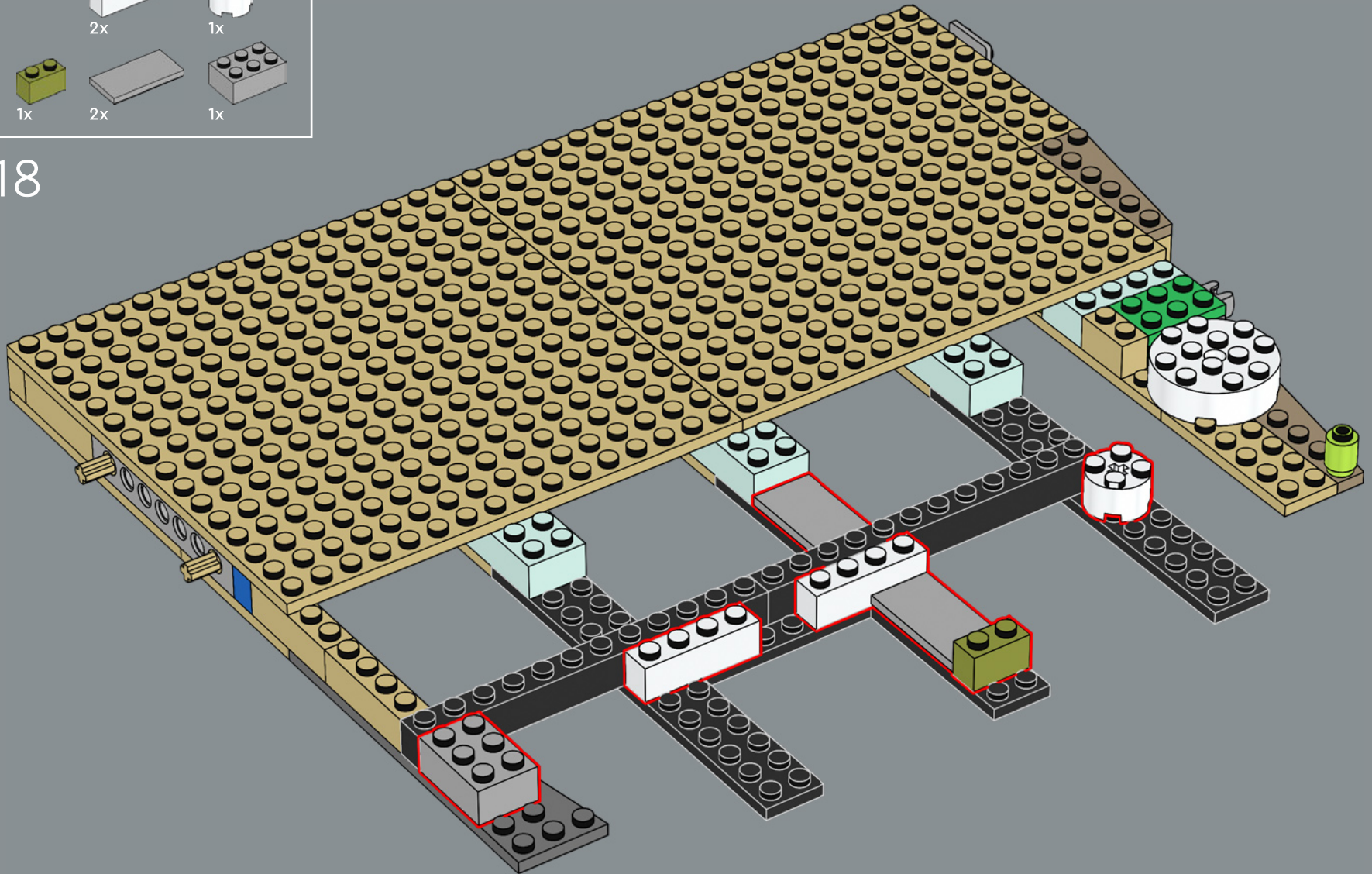

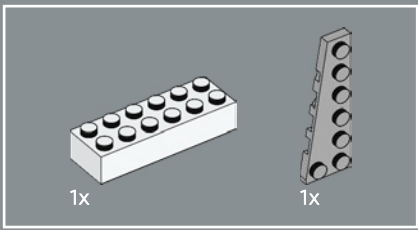

19

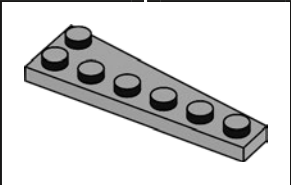
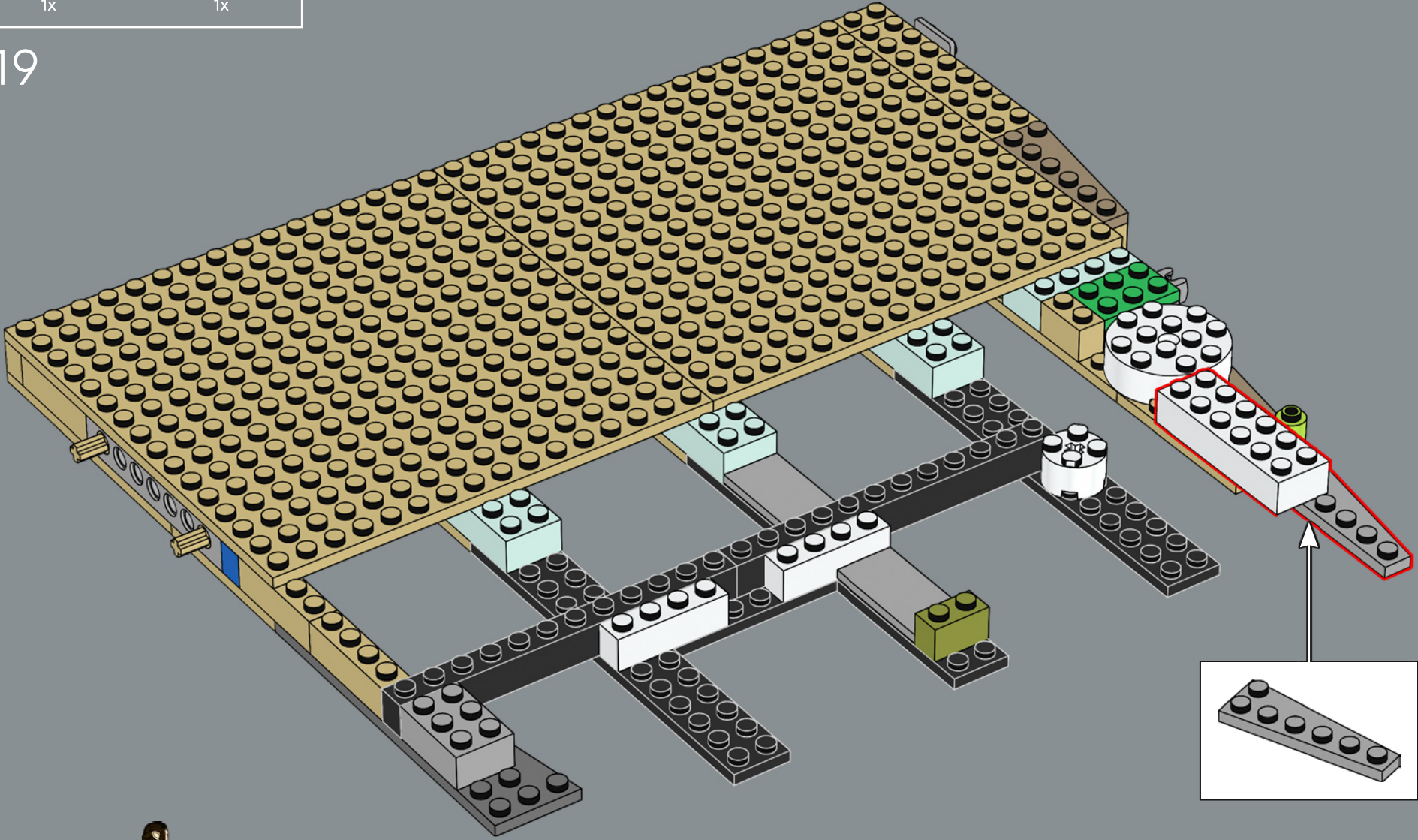

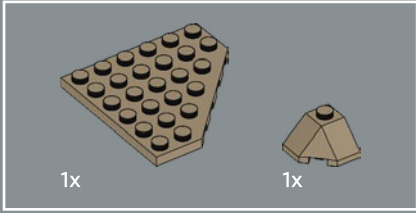
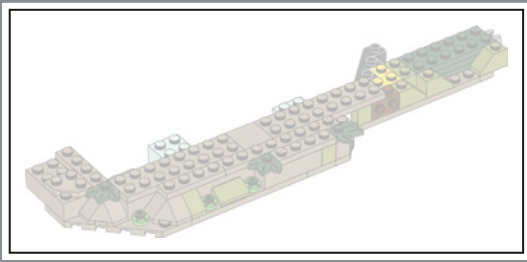

20

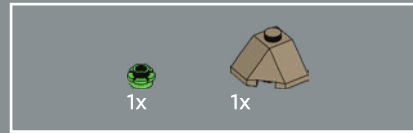
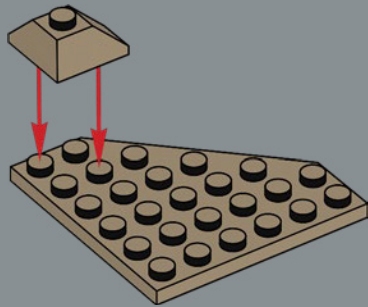

21

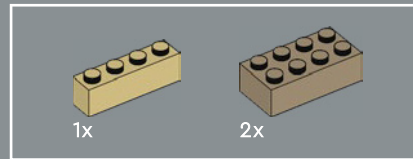
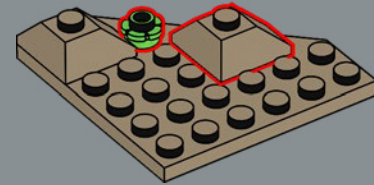

22

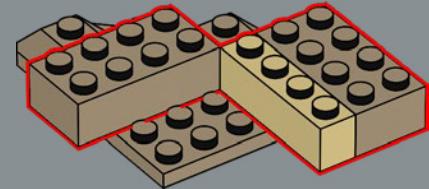

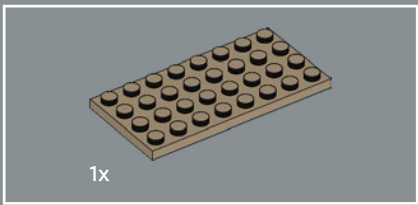

23

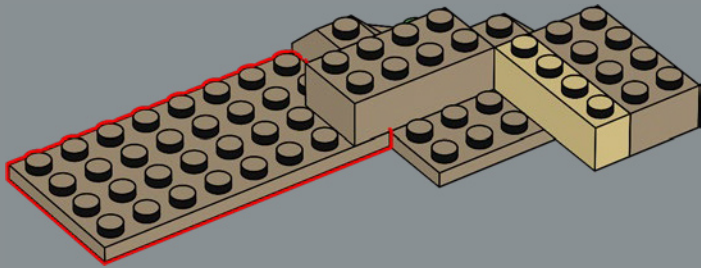

24

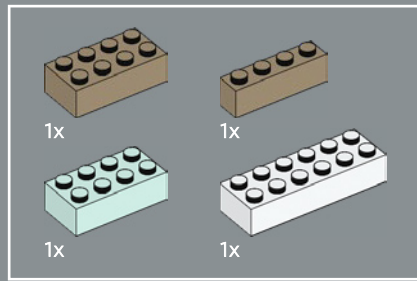
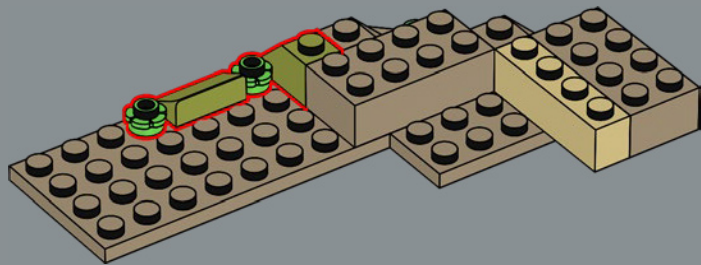

25

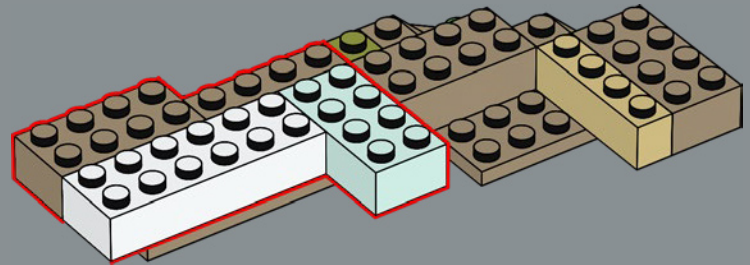

26

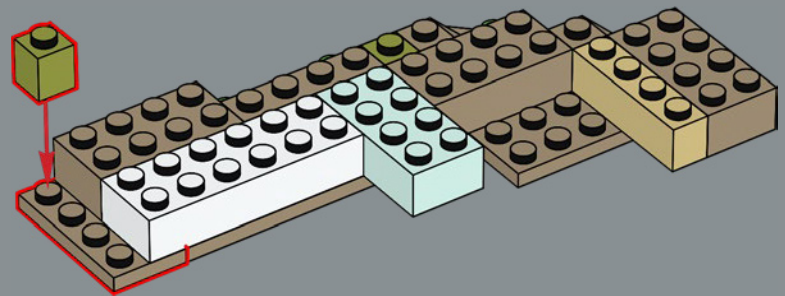

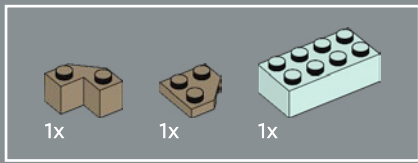

27

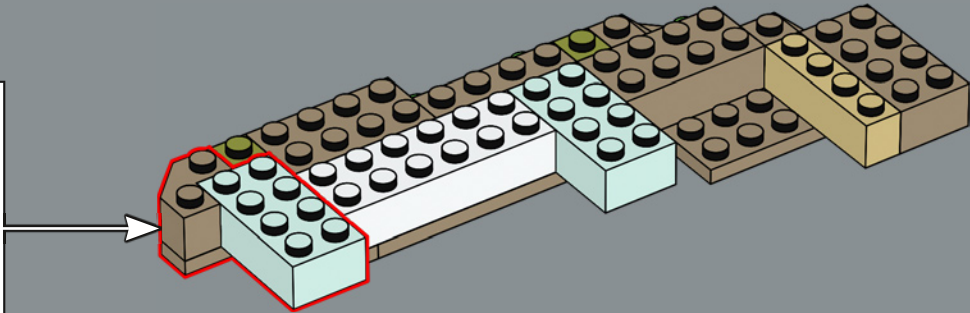
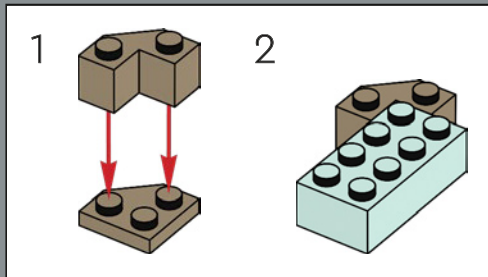

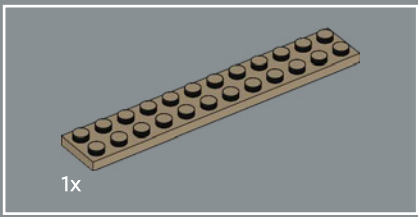

28

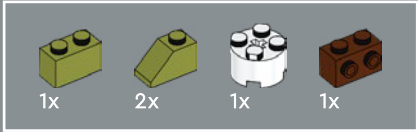
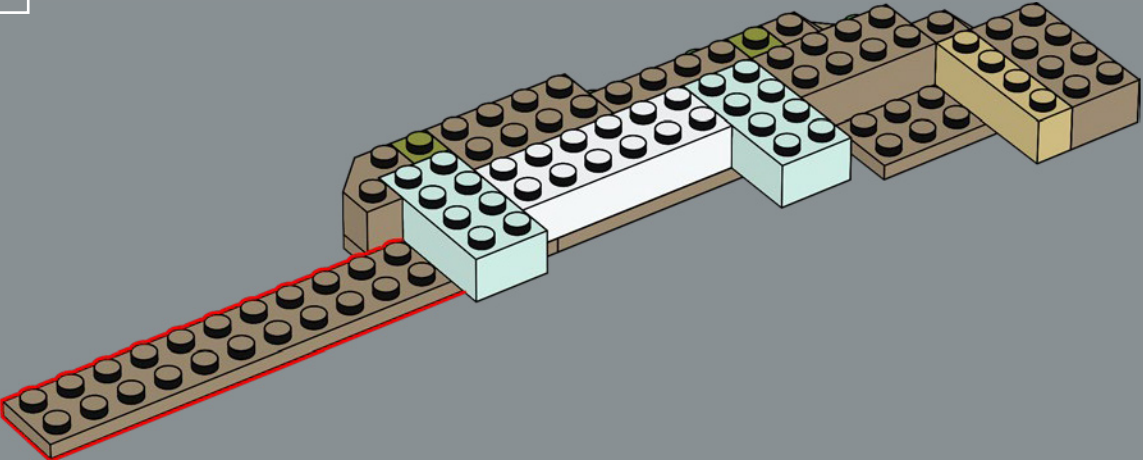

29

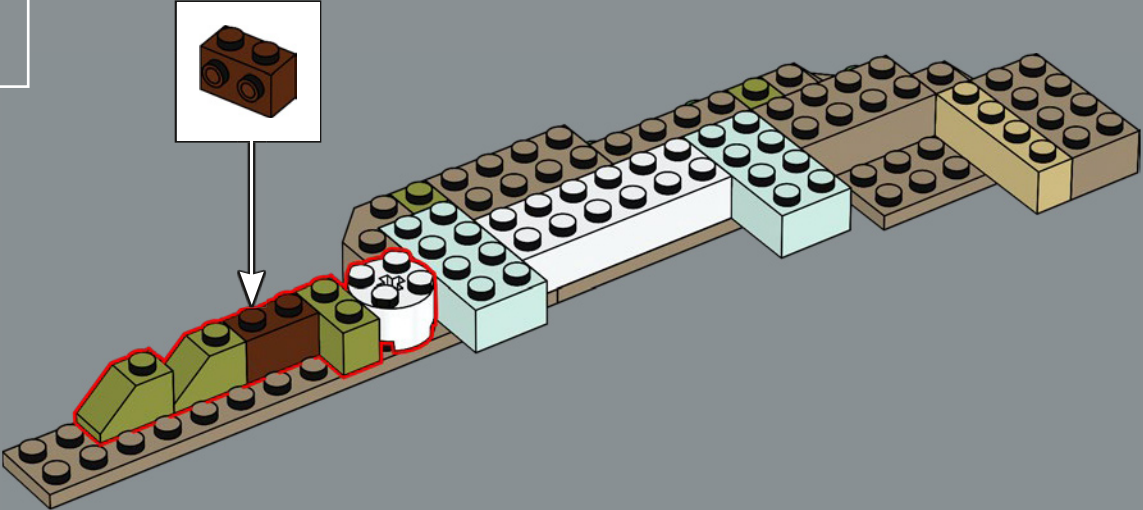

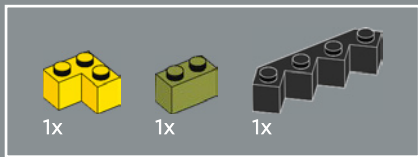

30

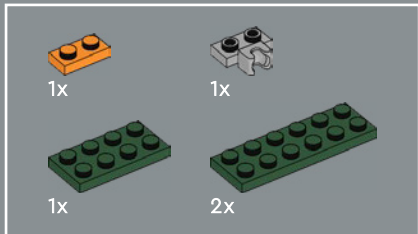
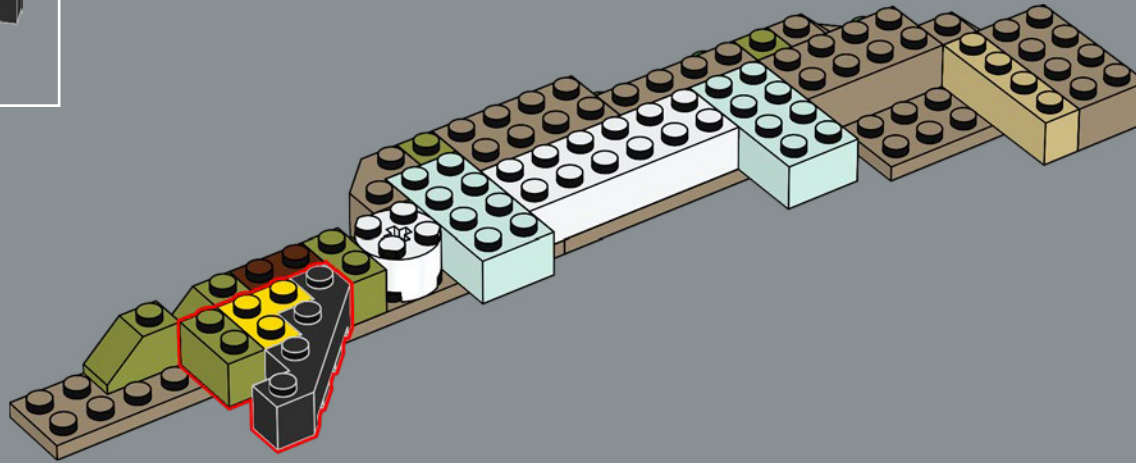

31

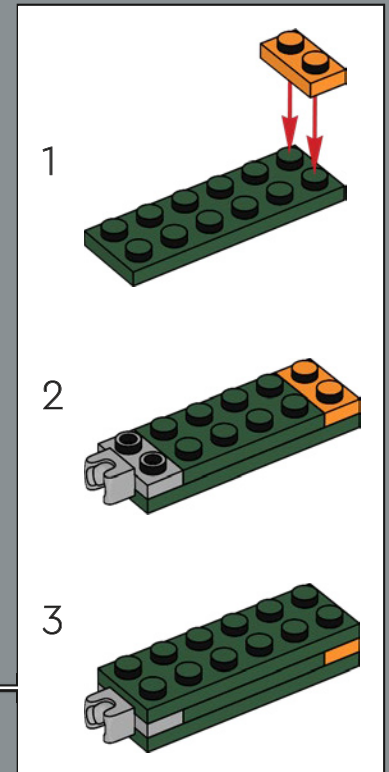
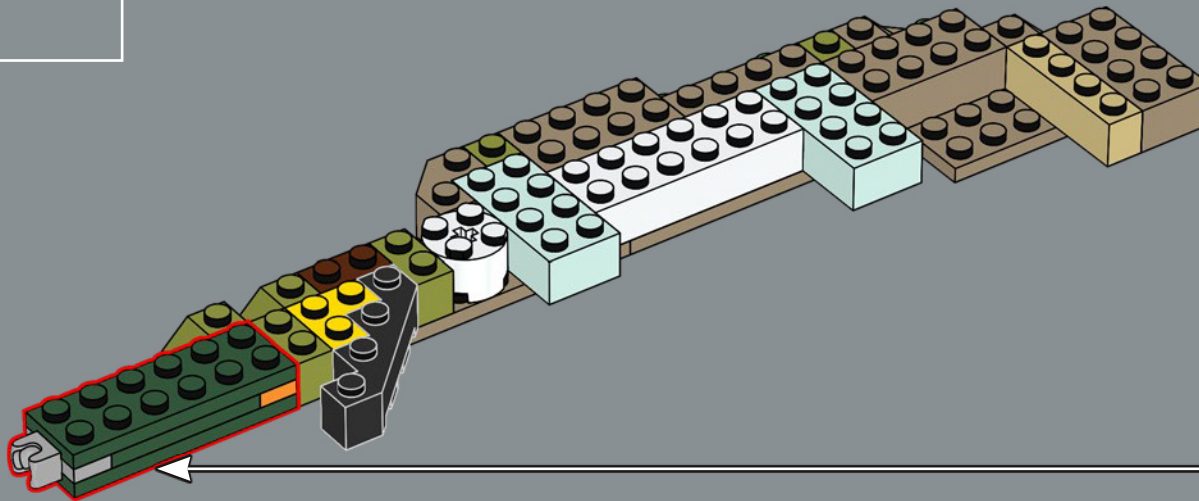

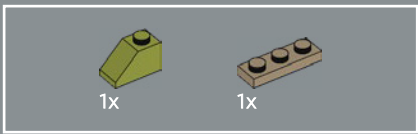

32

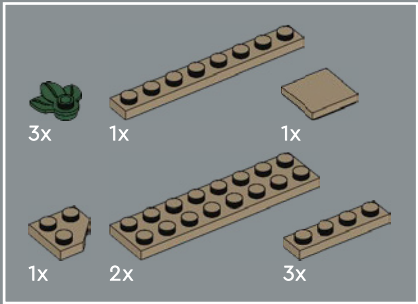
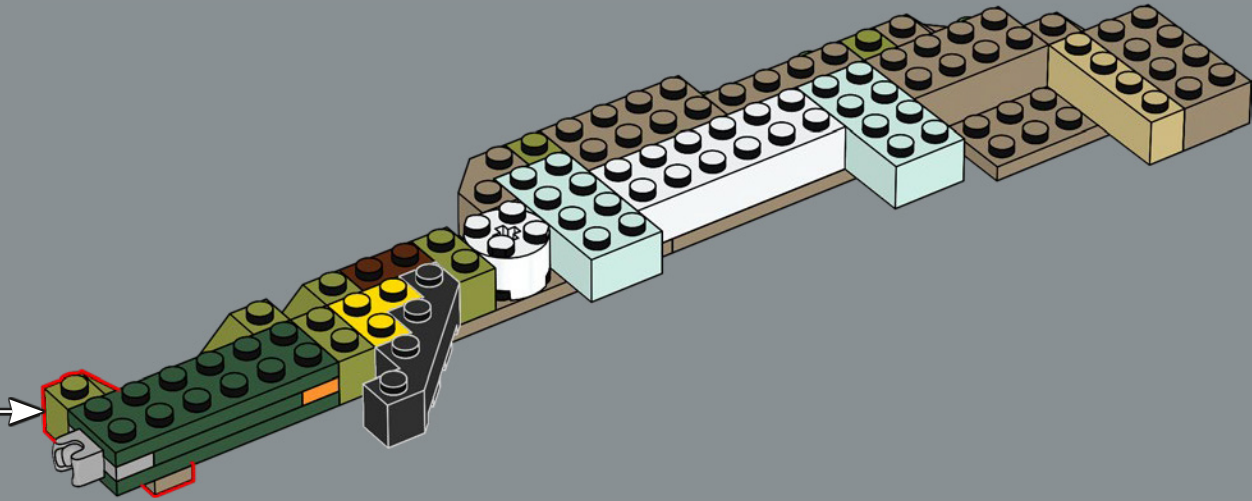
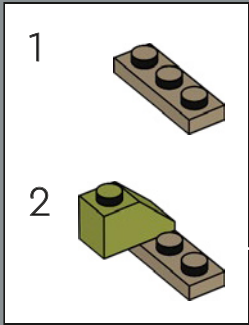

33

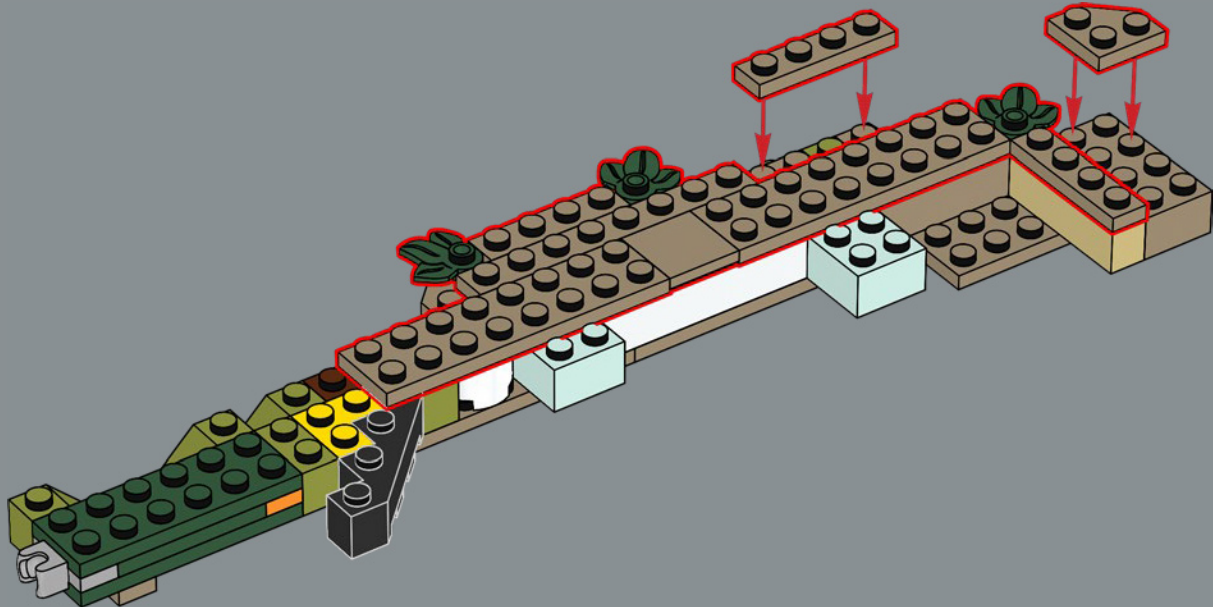

34

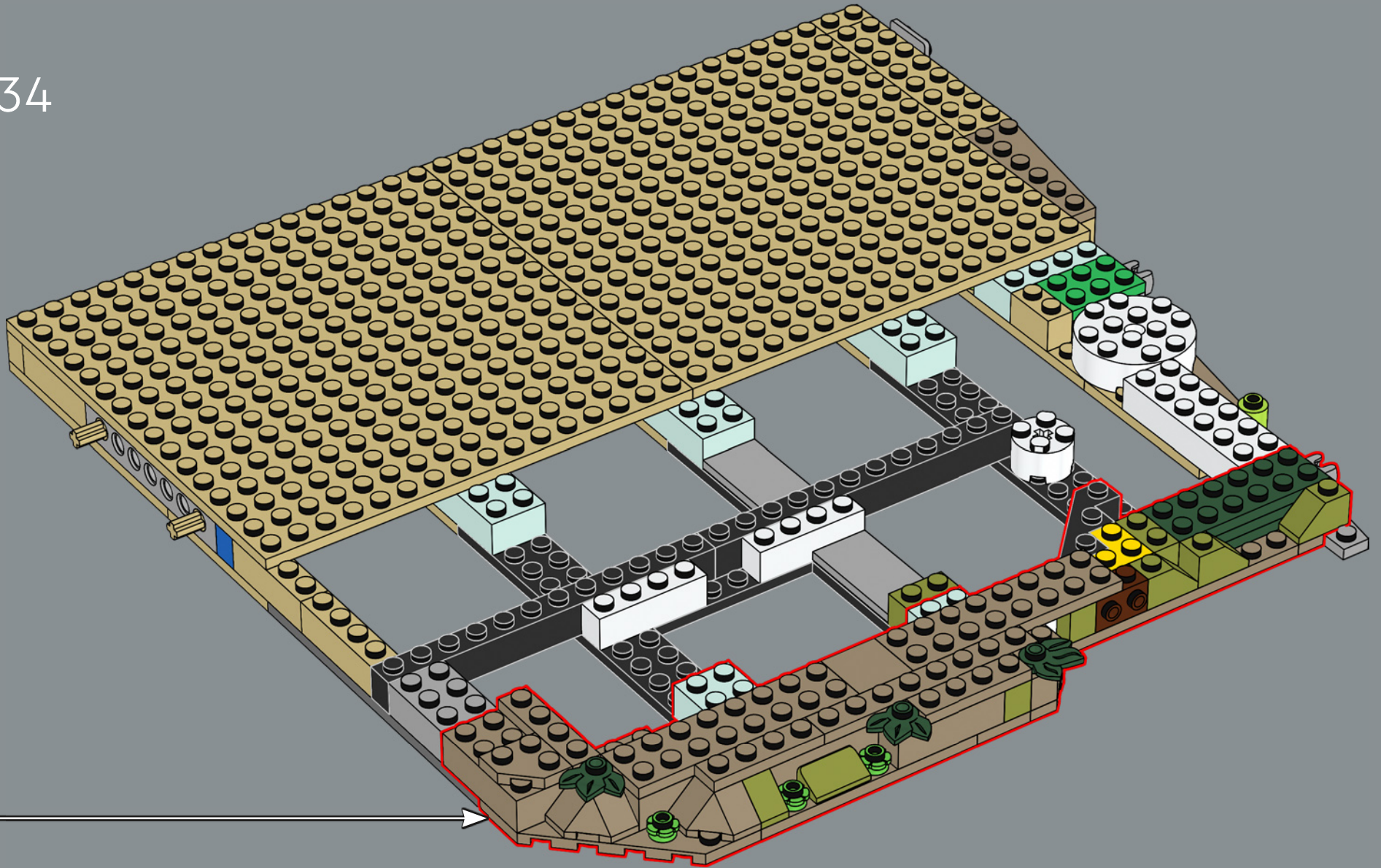

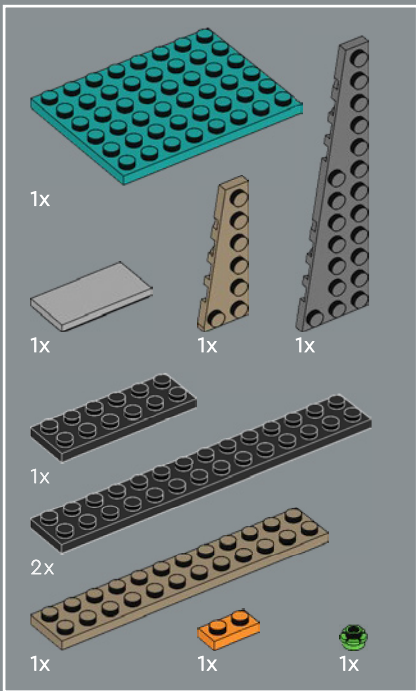

35

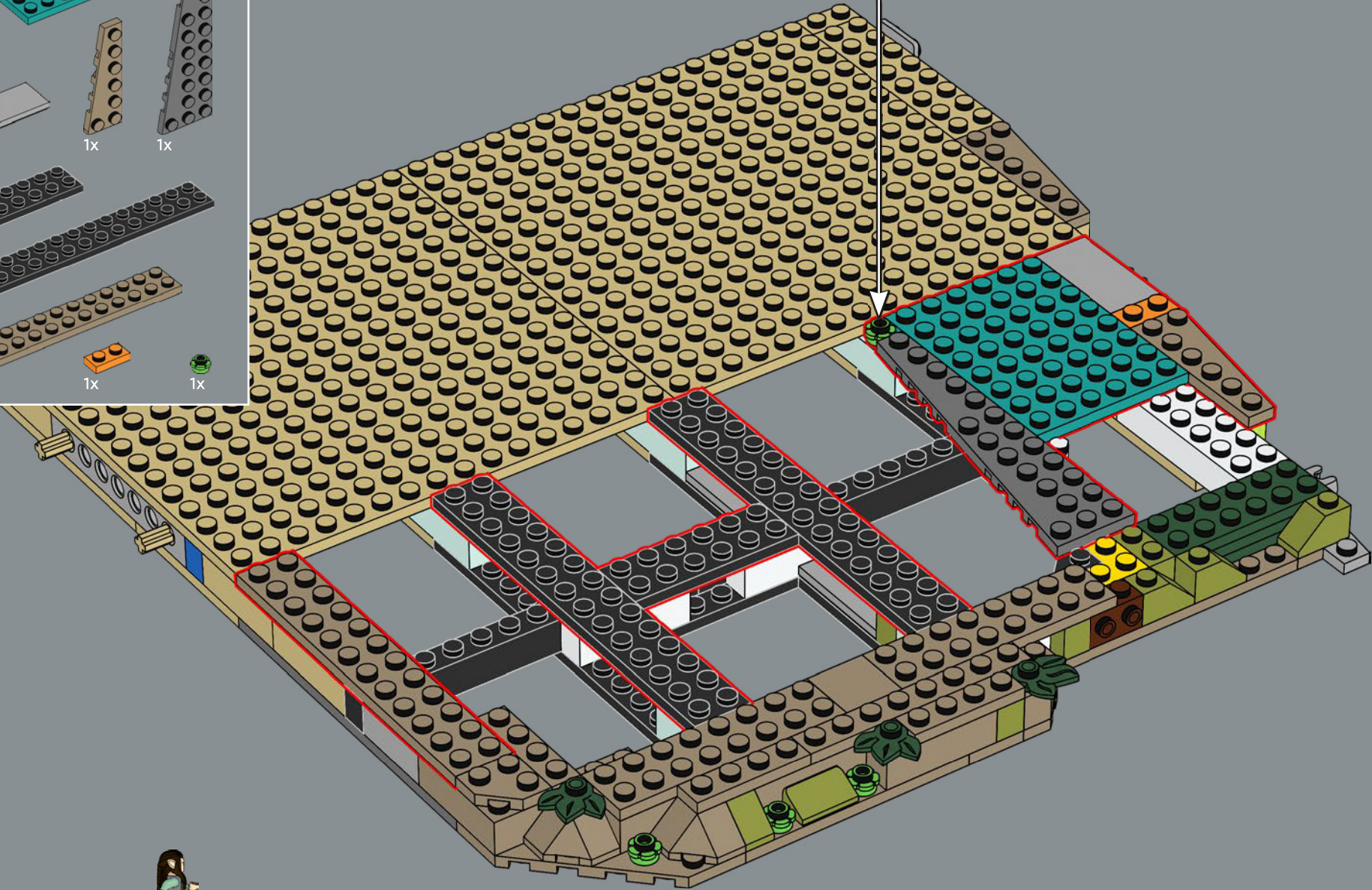

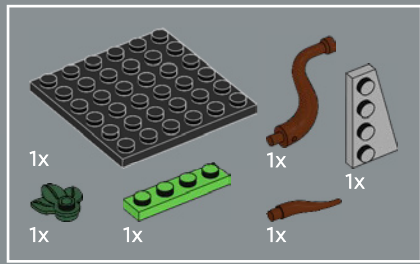

36

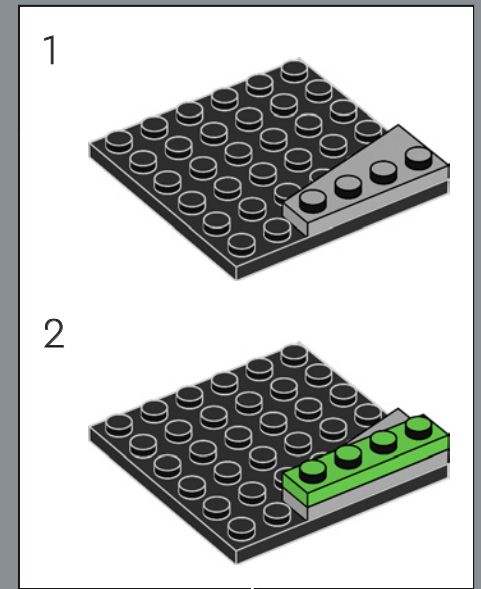
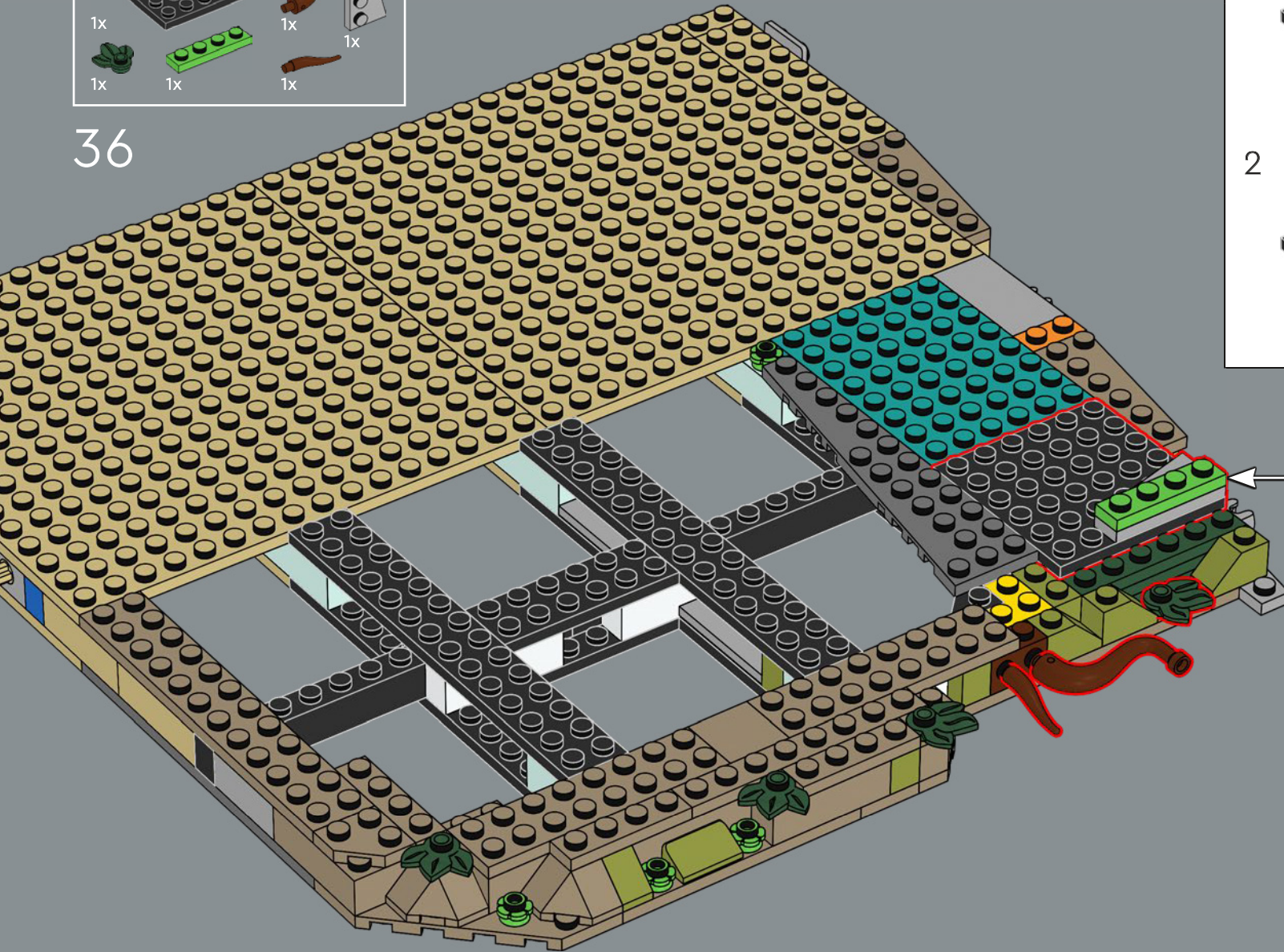

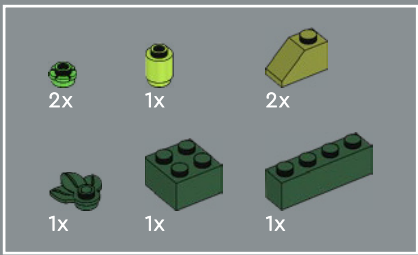

37

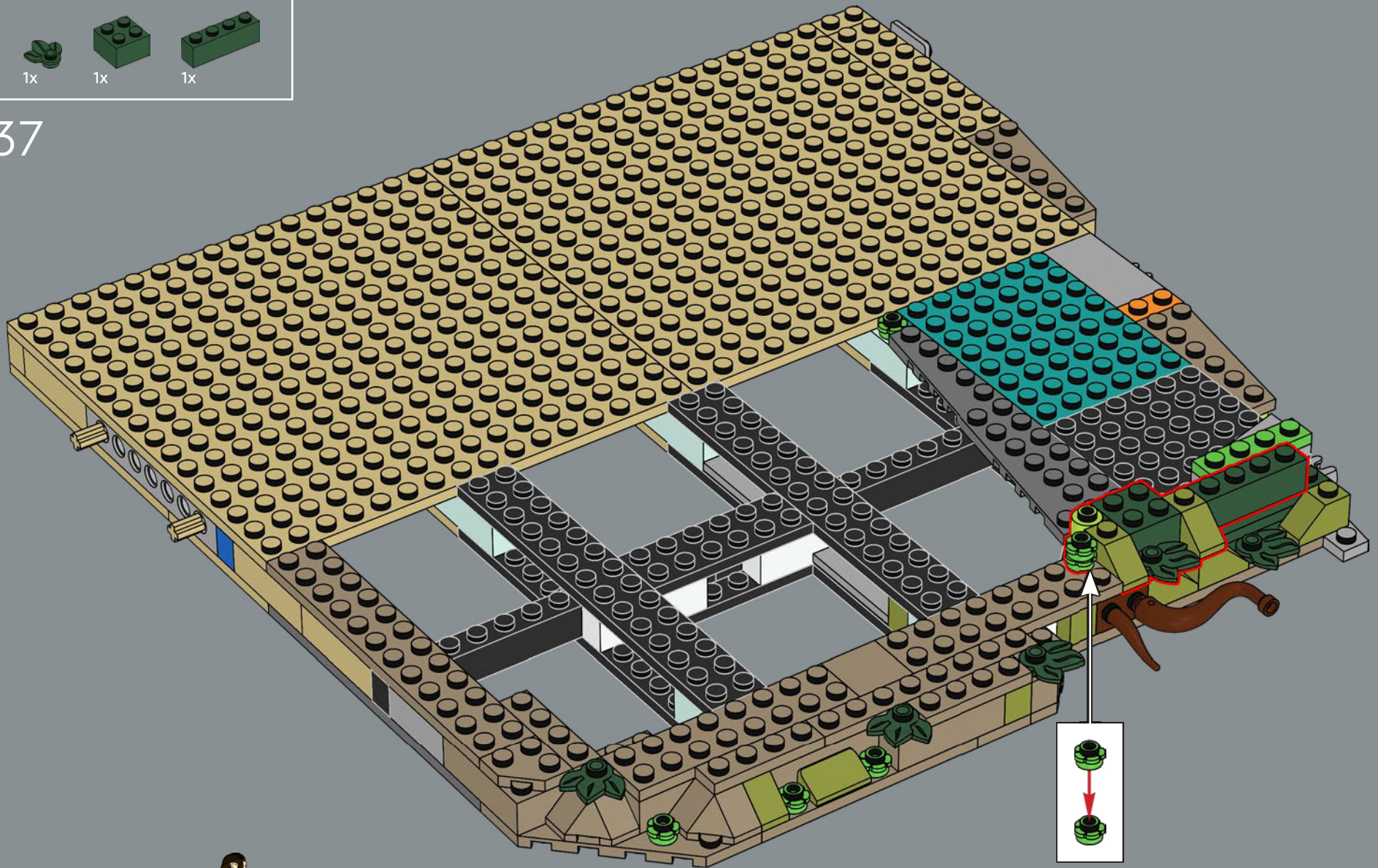

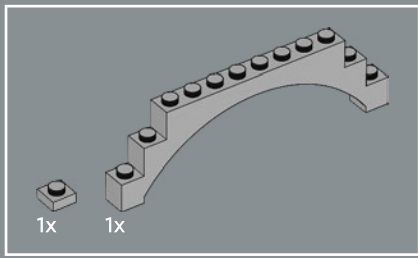

38

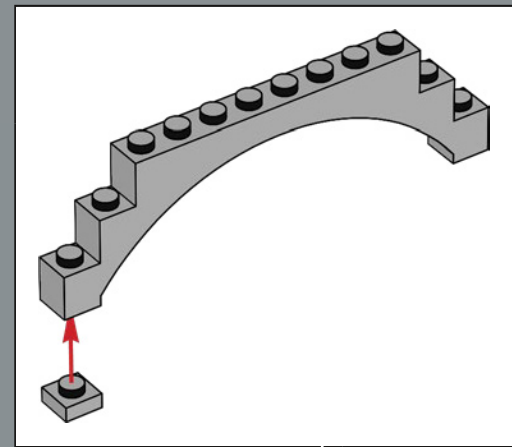
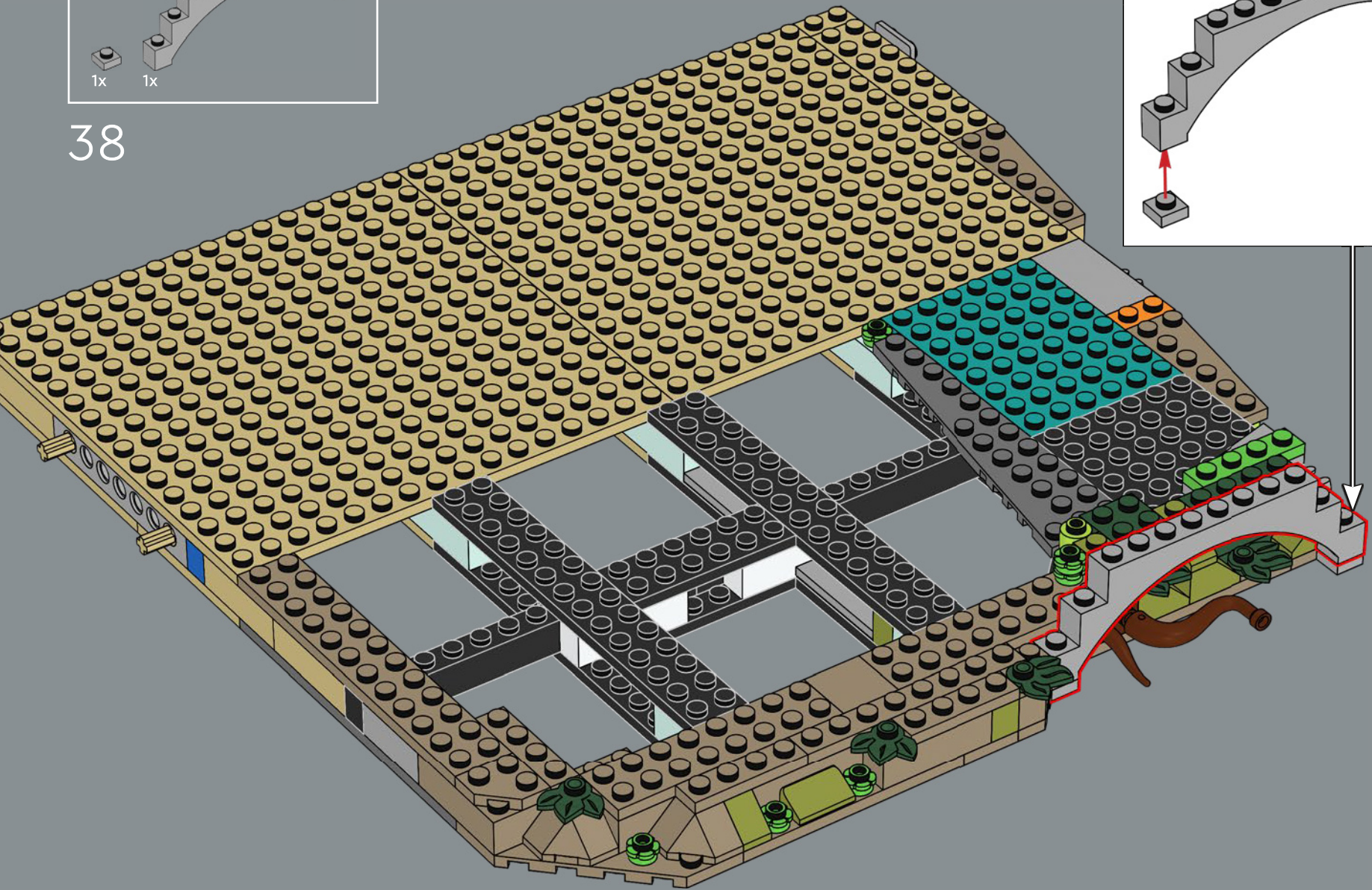

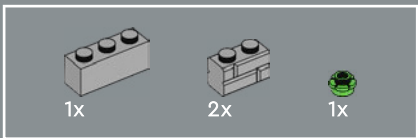

39

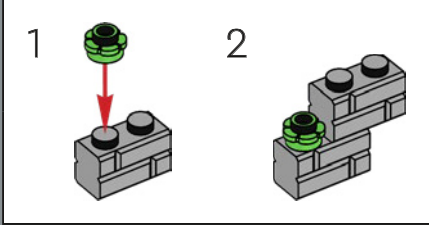
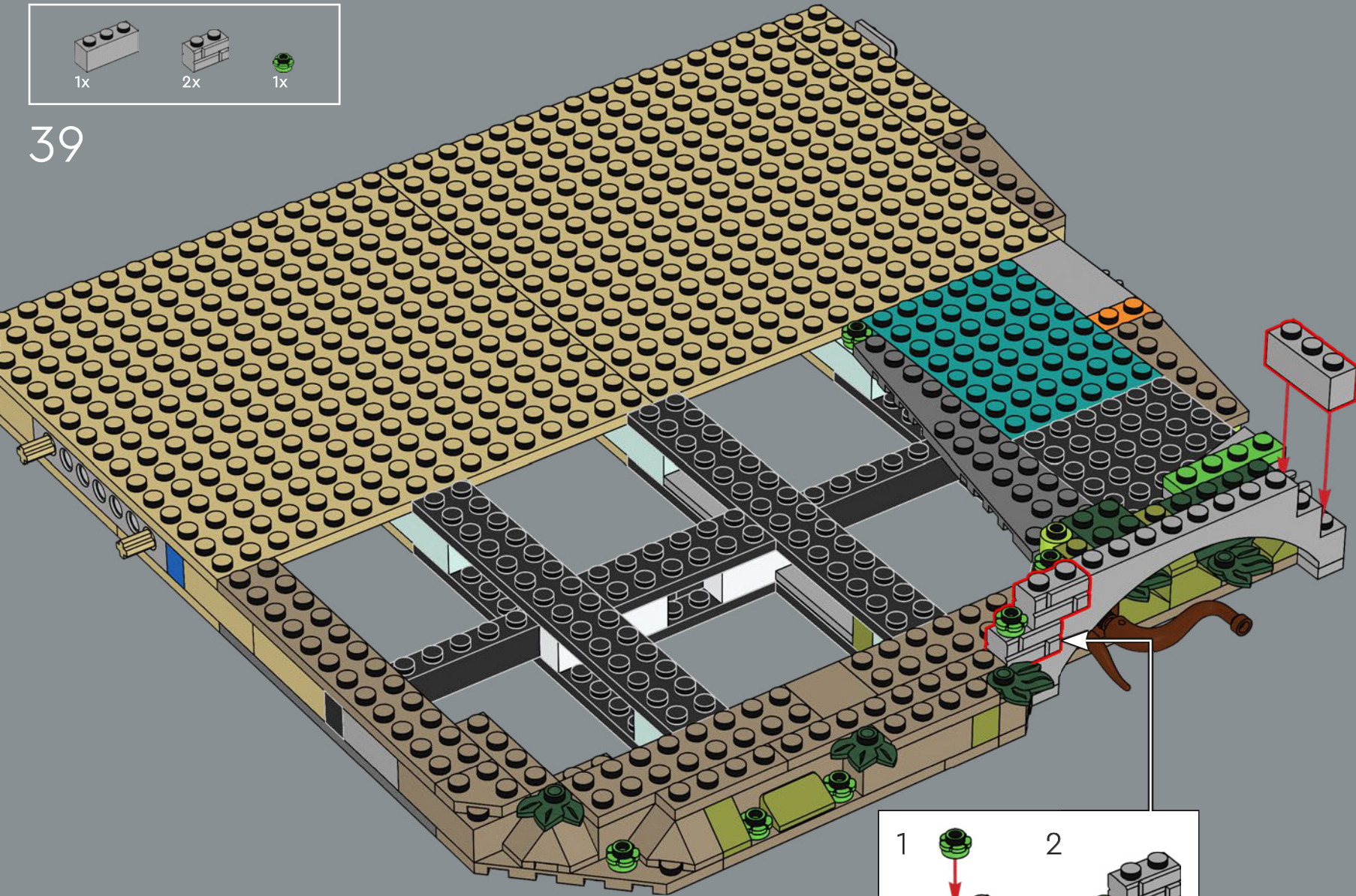

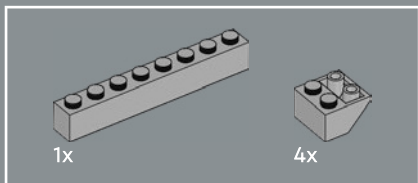

40

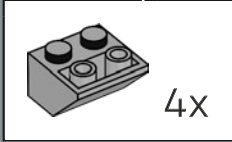
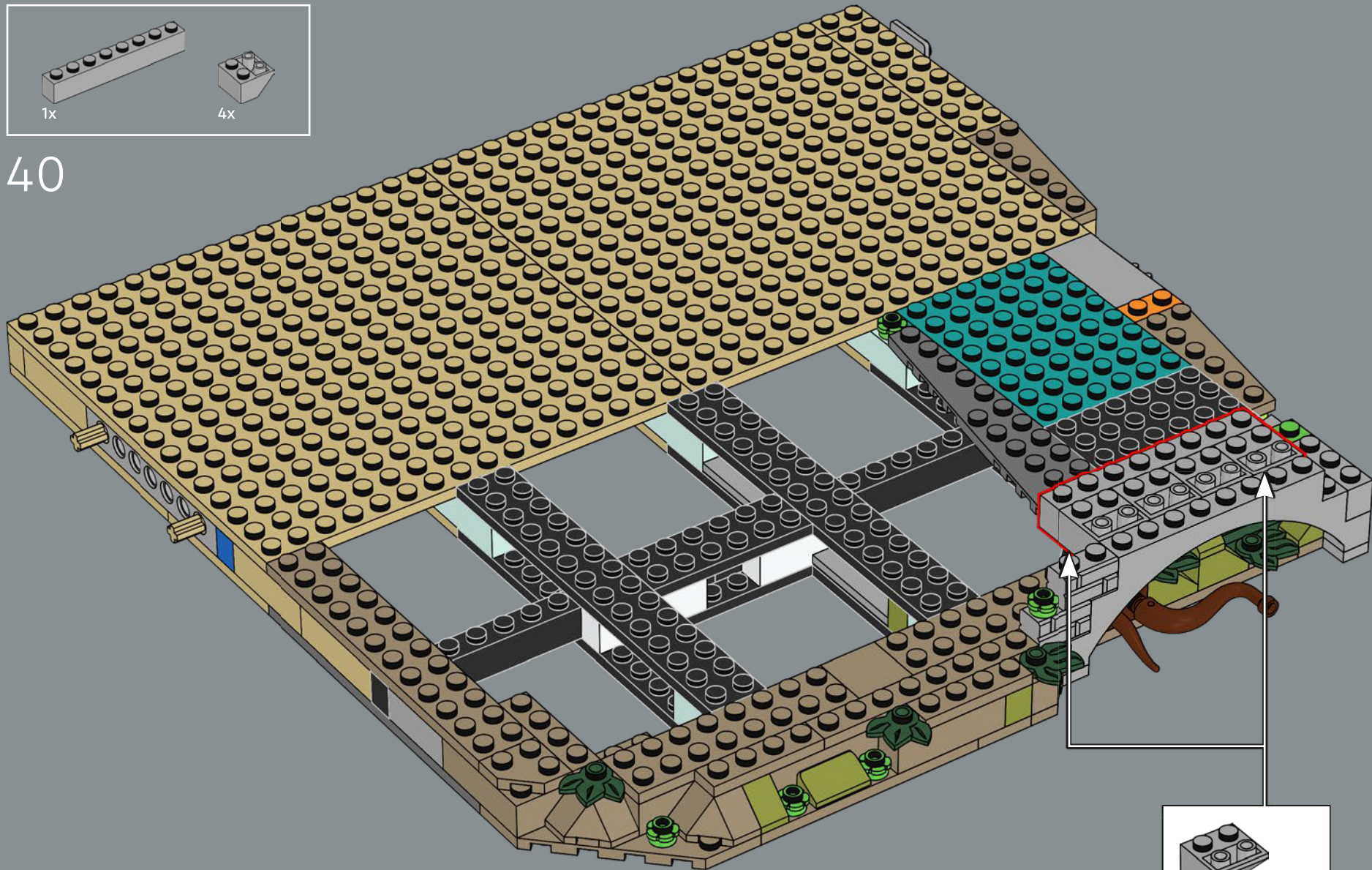

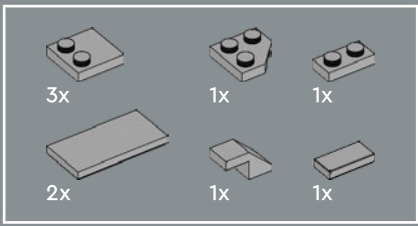

41

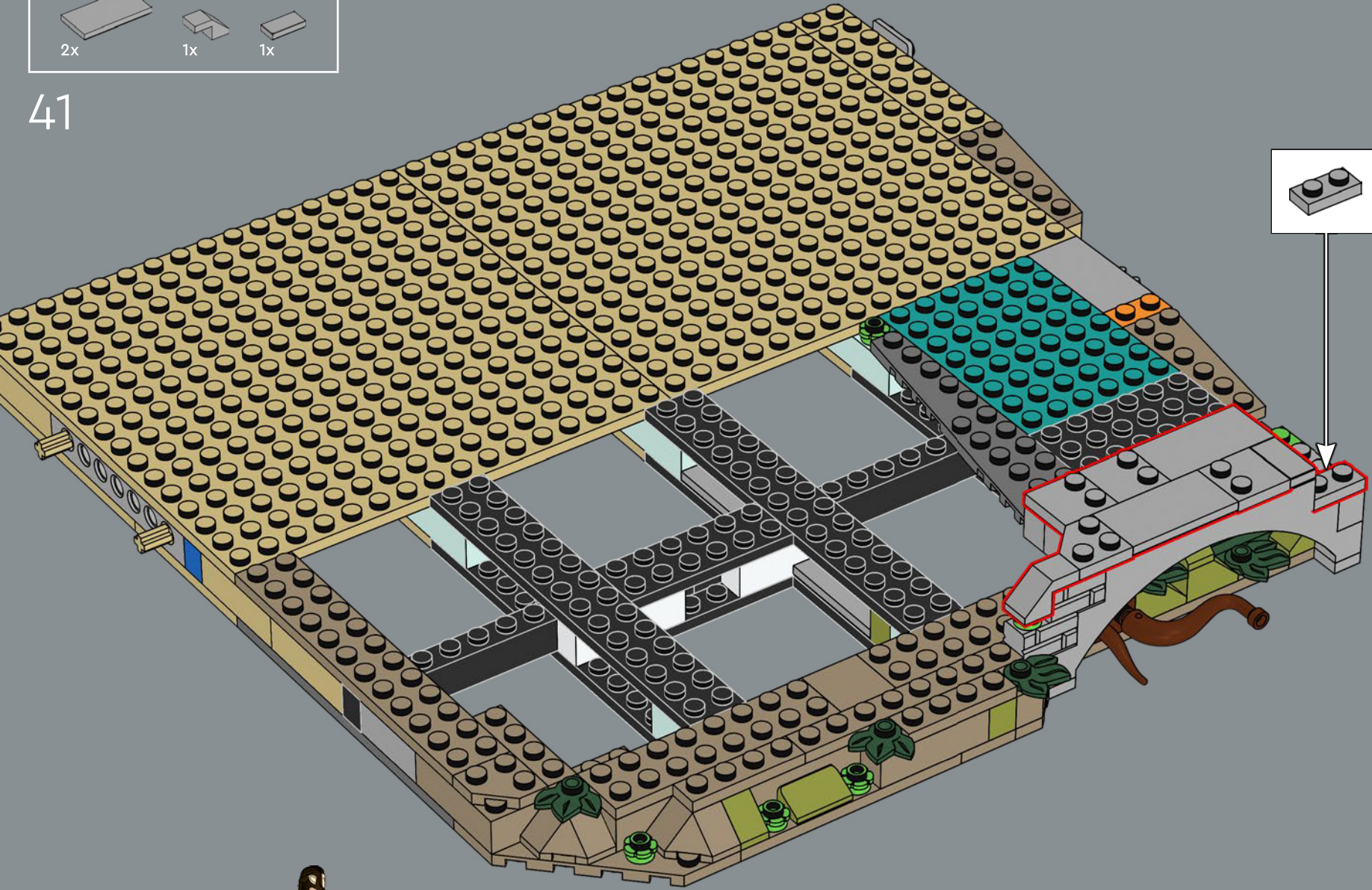

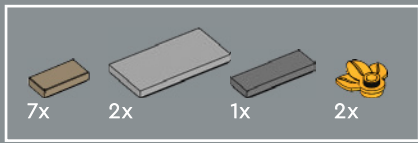

42

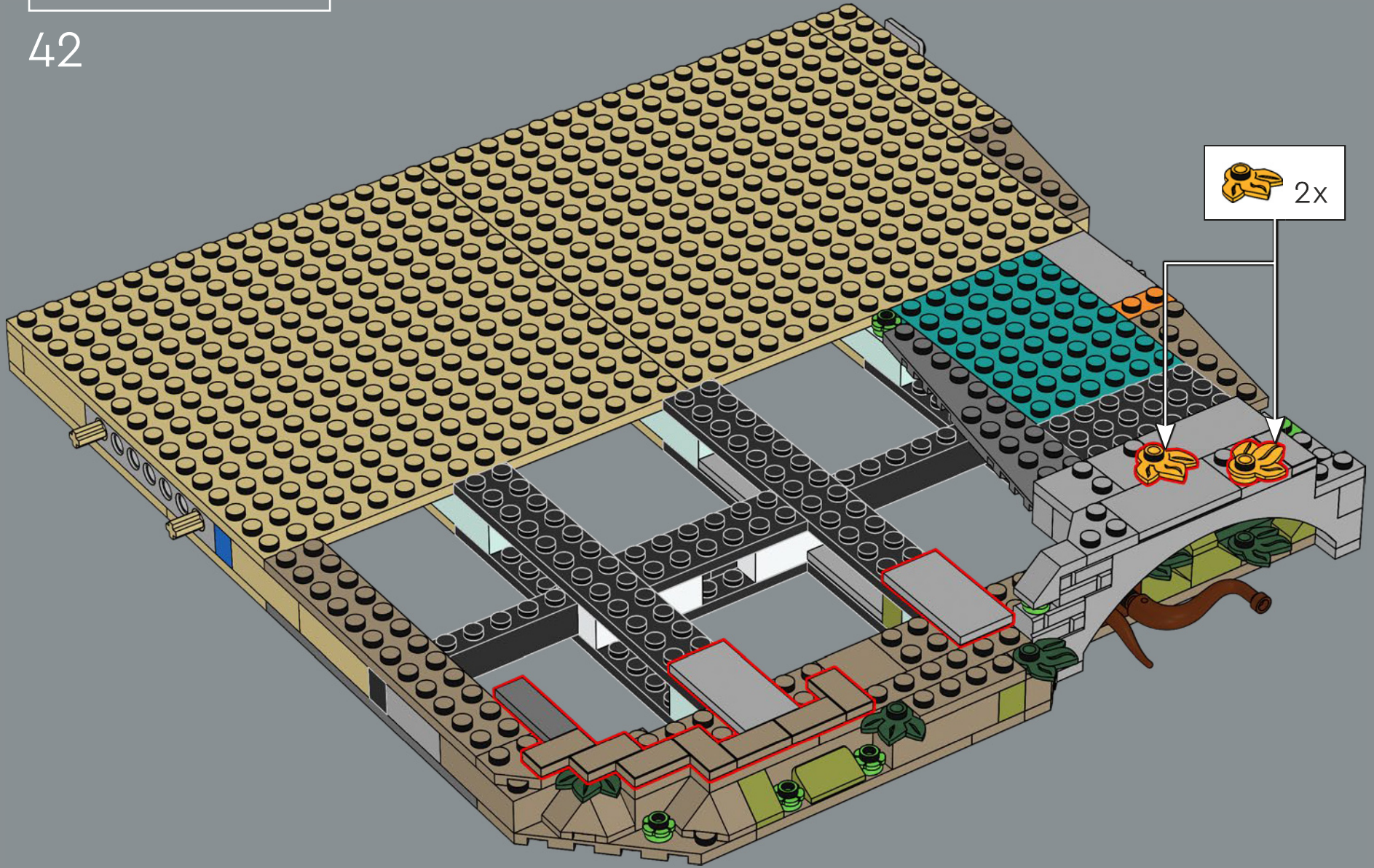



Die neue Bodenfliese ist 64 Mal enthalten. Das reicht, um eine 16x16 Platte vollständig zu verzieren.

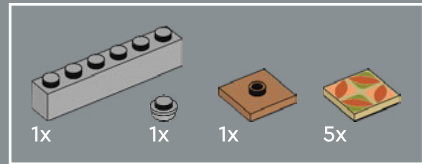

43

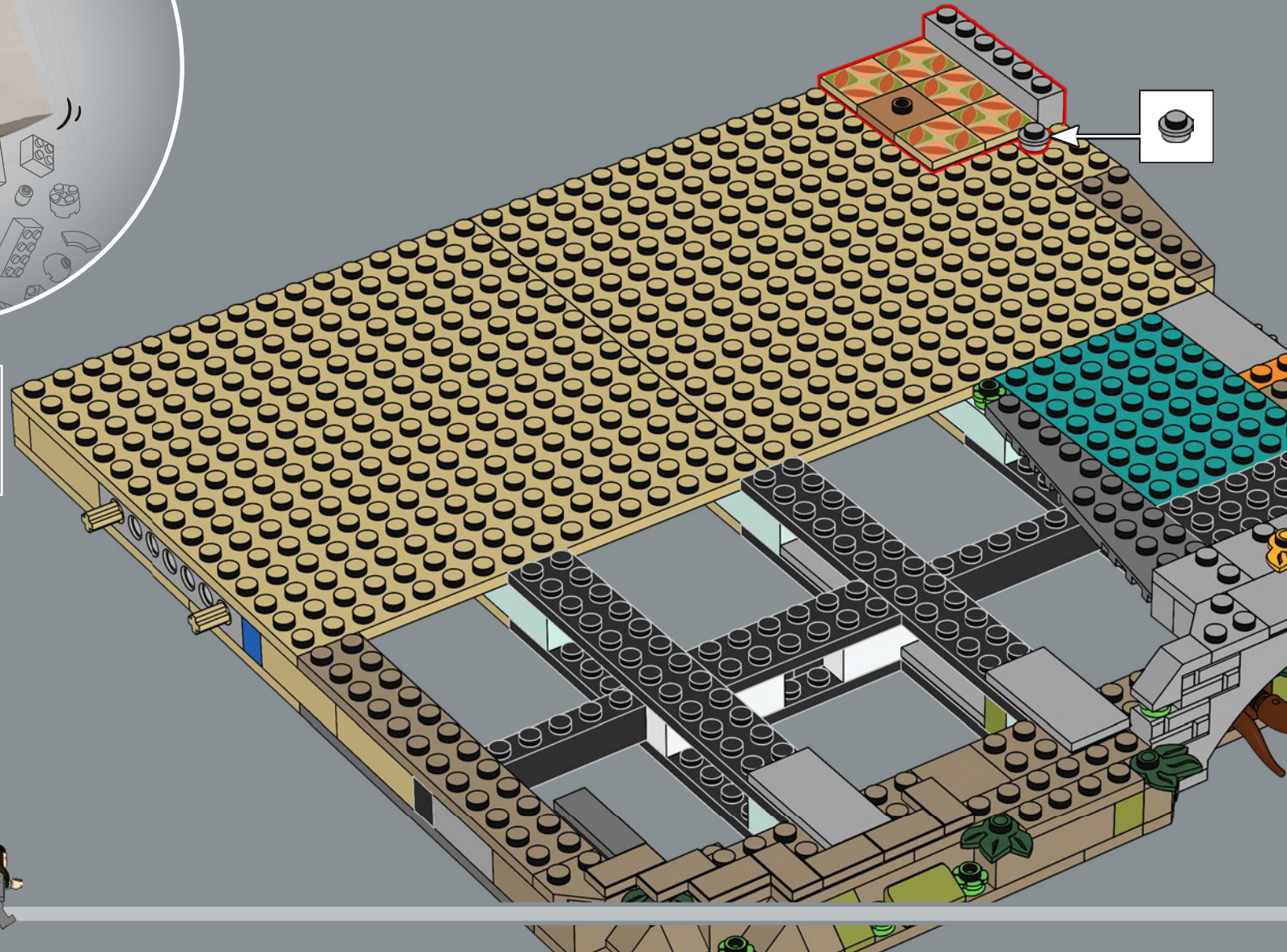



44

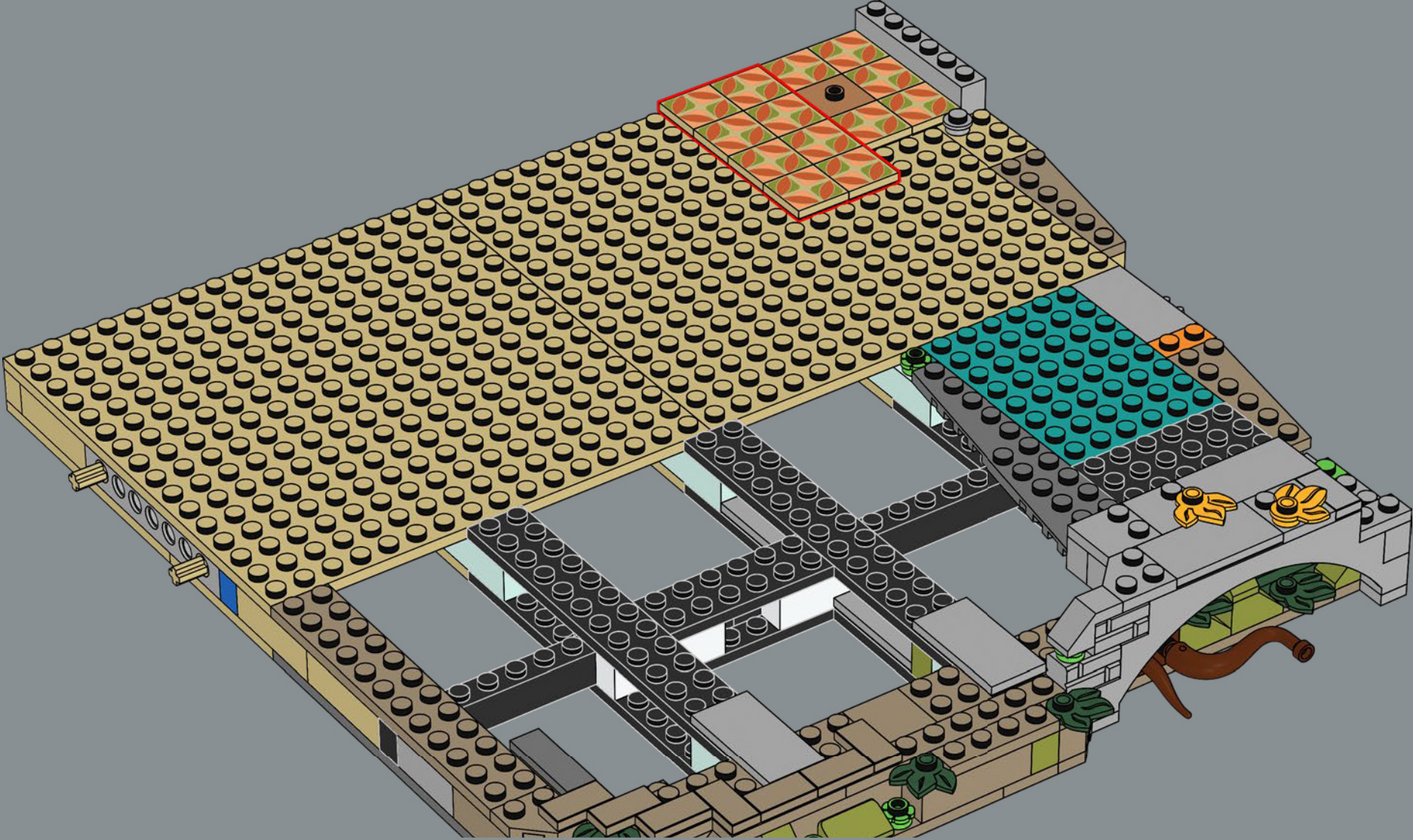

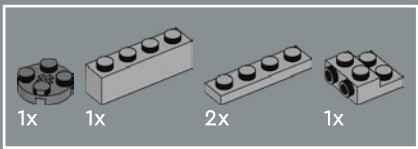

45

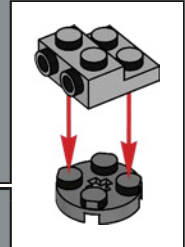
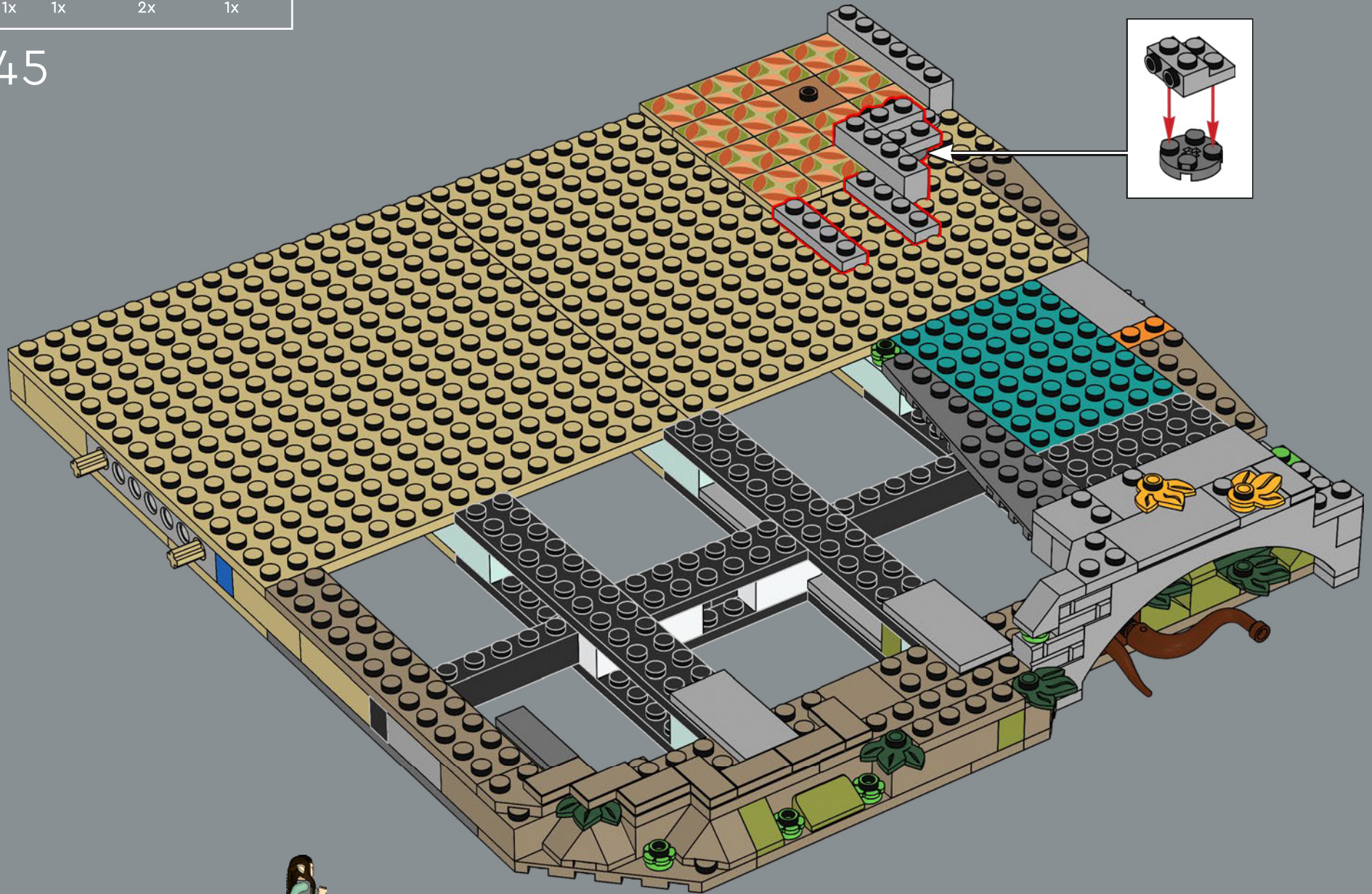

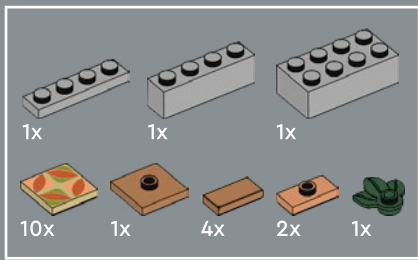

46

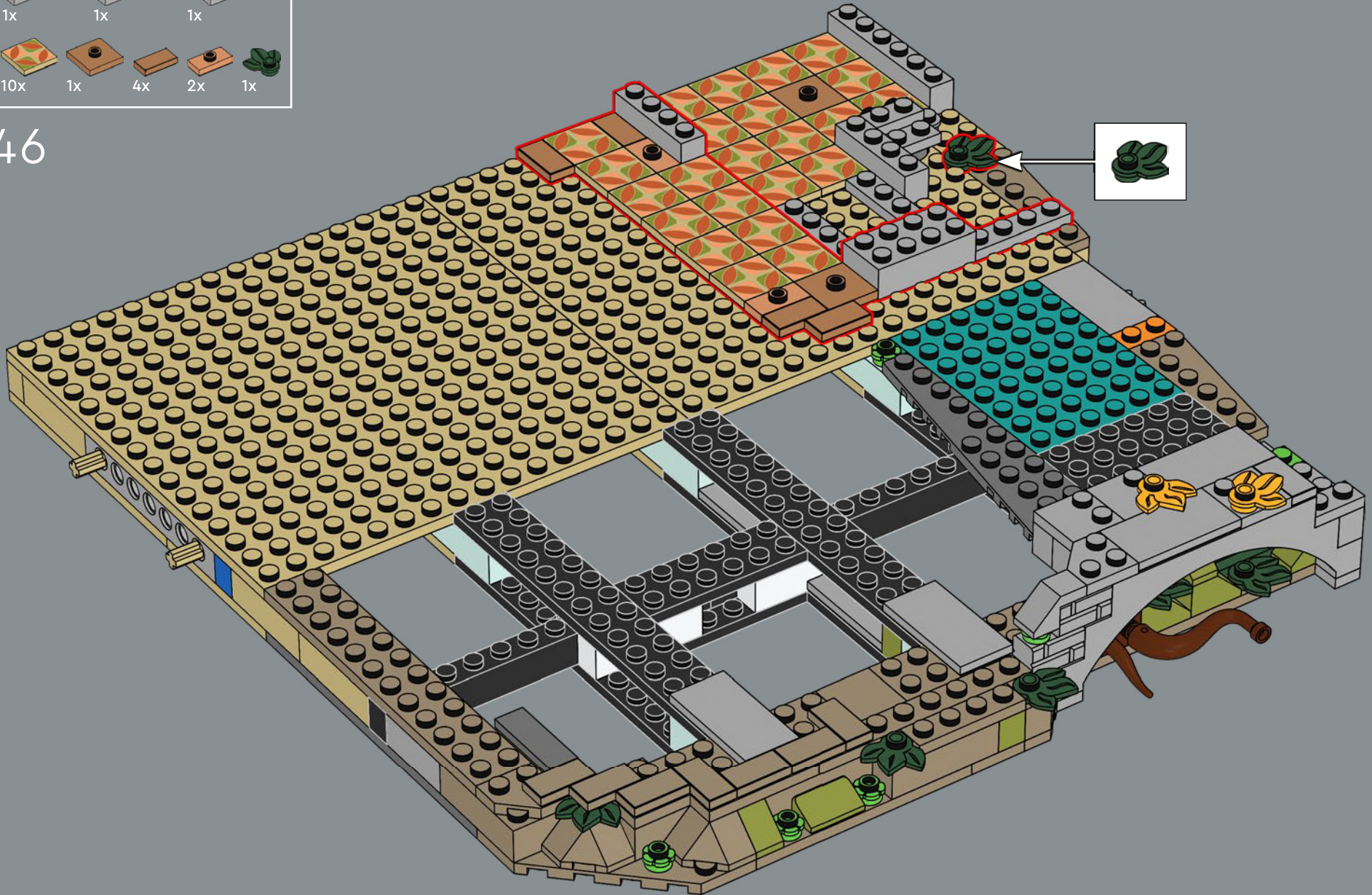

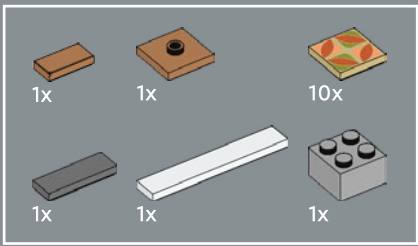

47



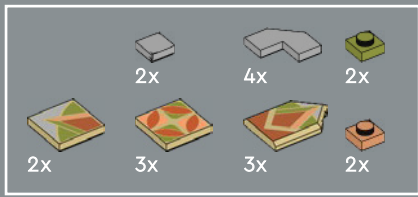

48

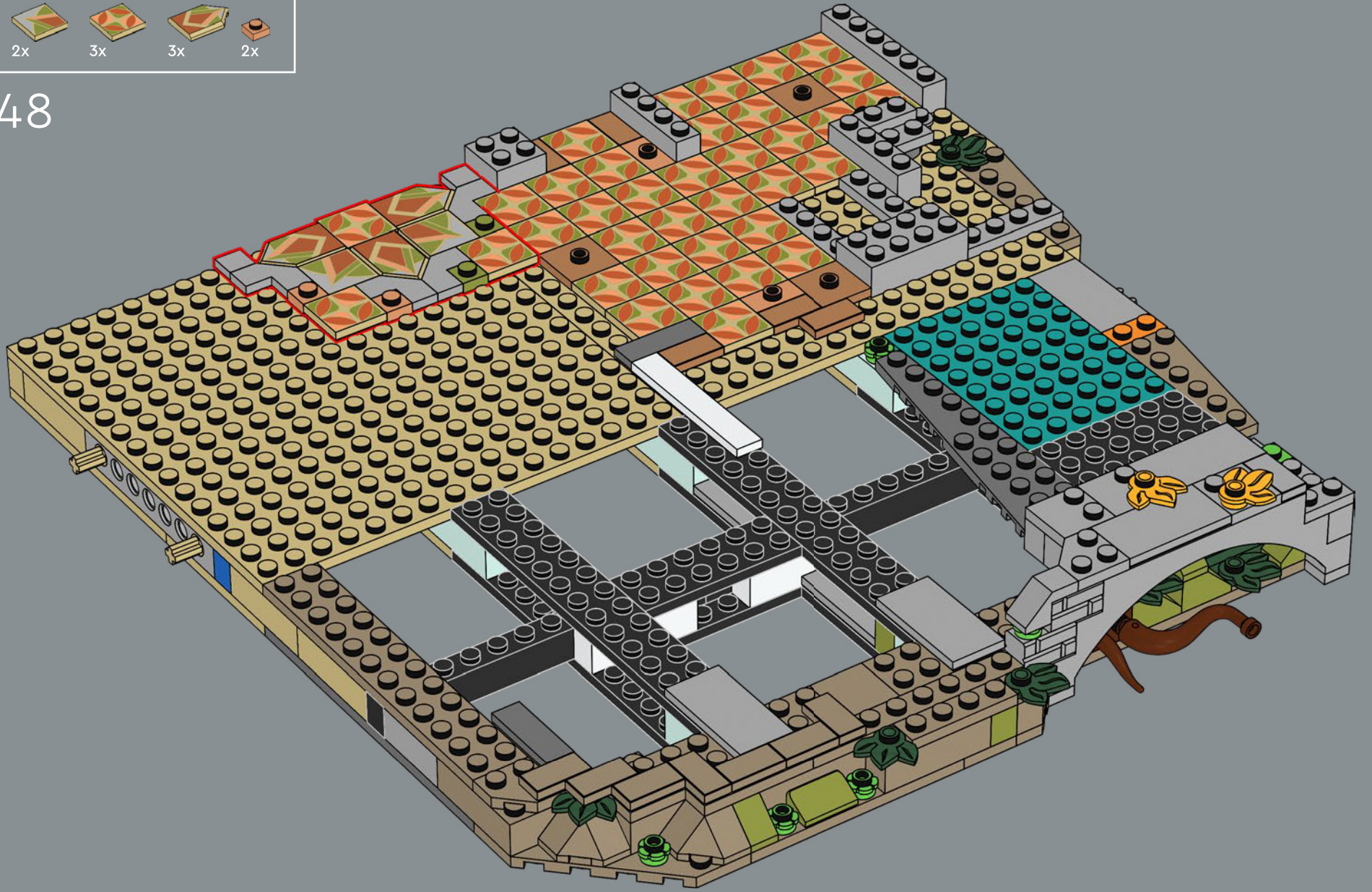

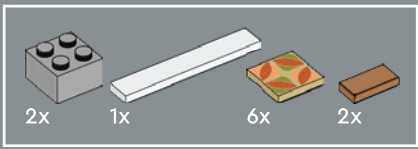

49



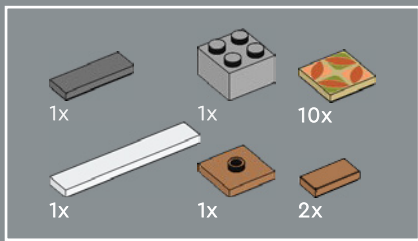

50

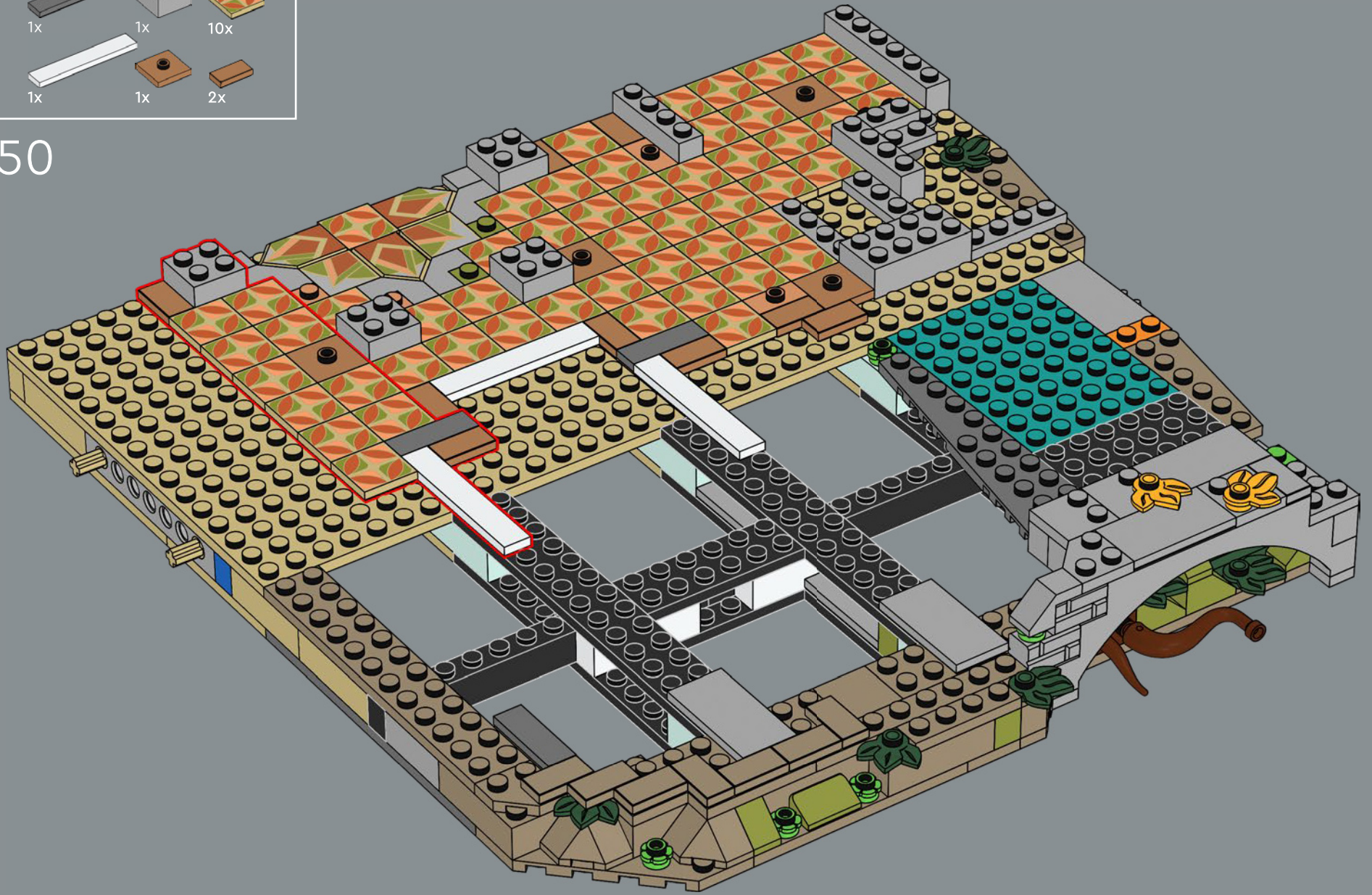

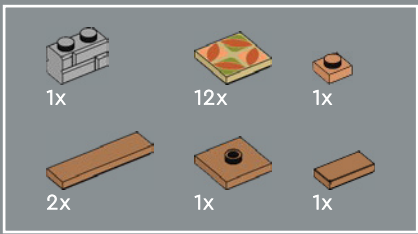

51



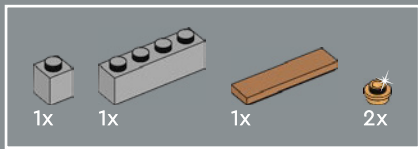

52



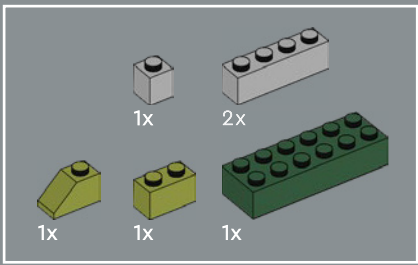

53

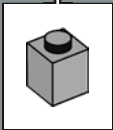
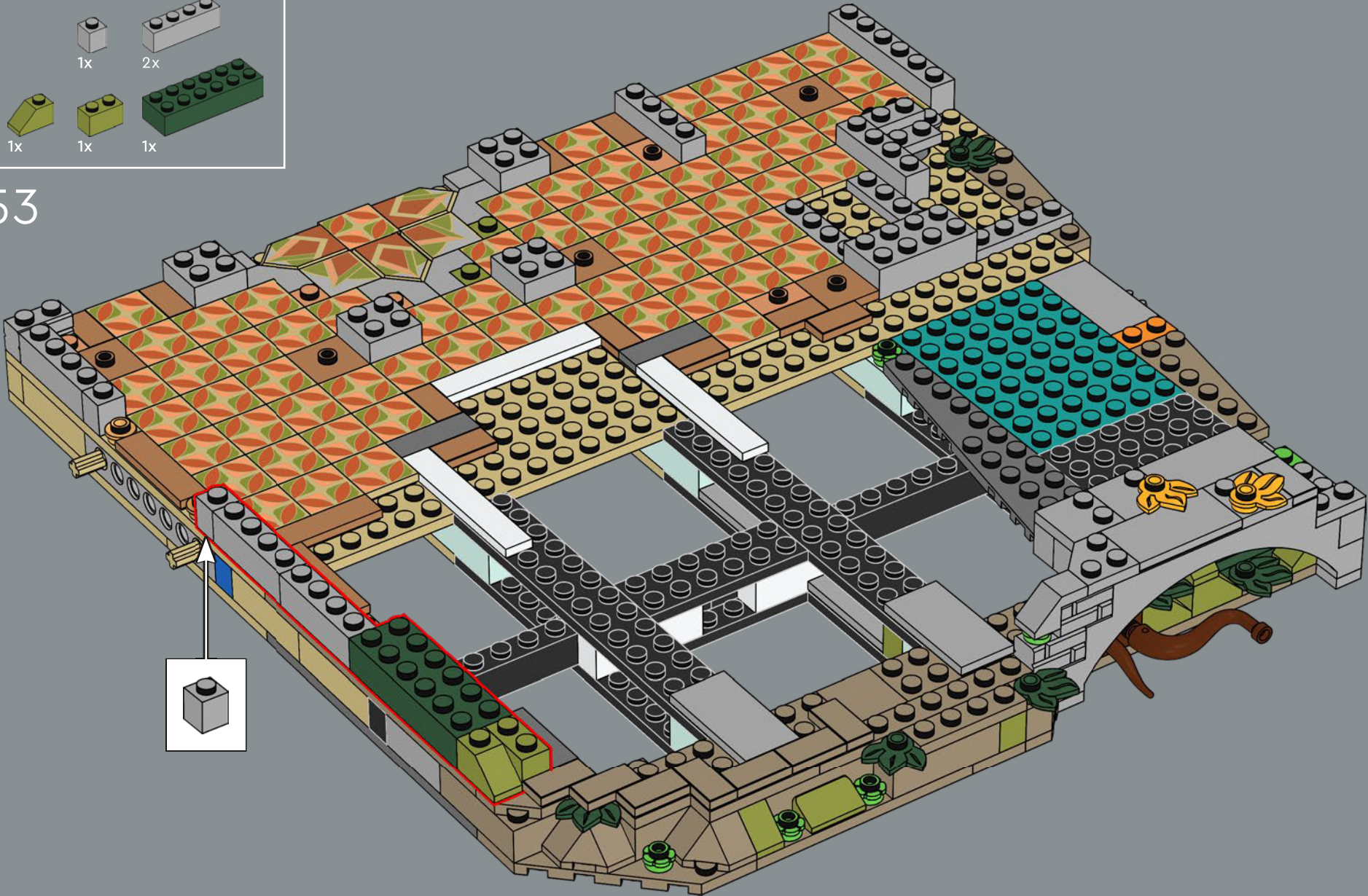

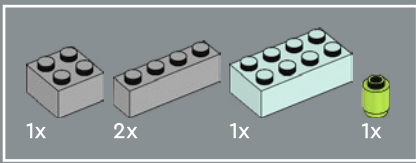

54



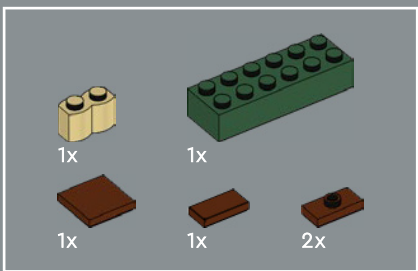

55

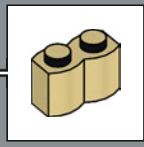
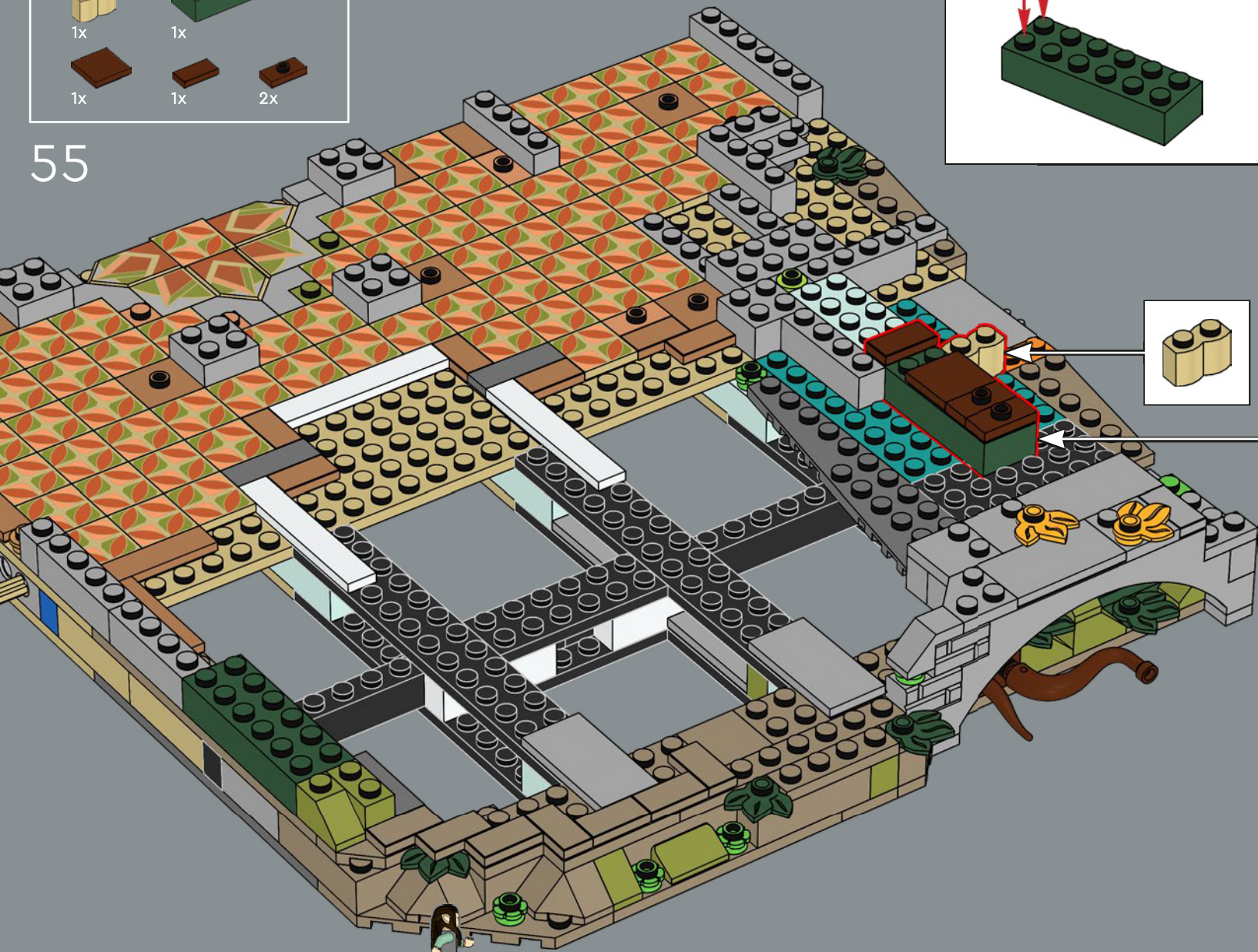
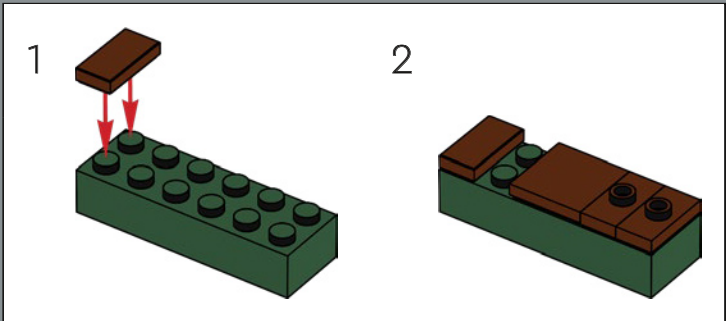

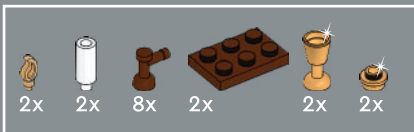

56

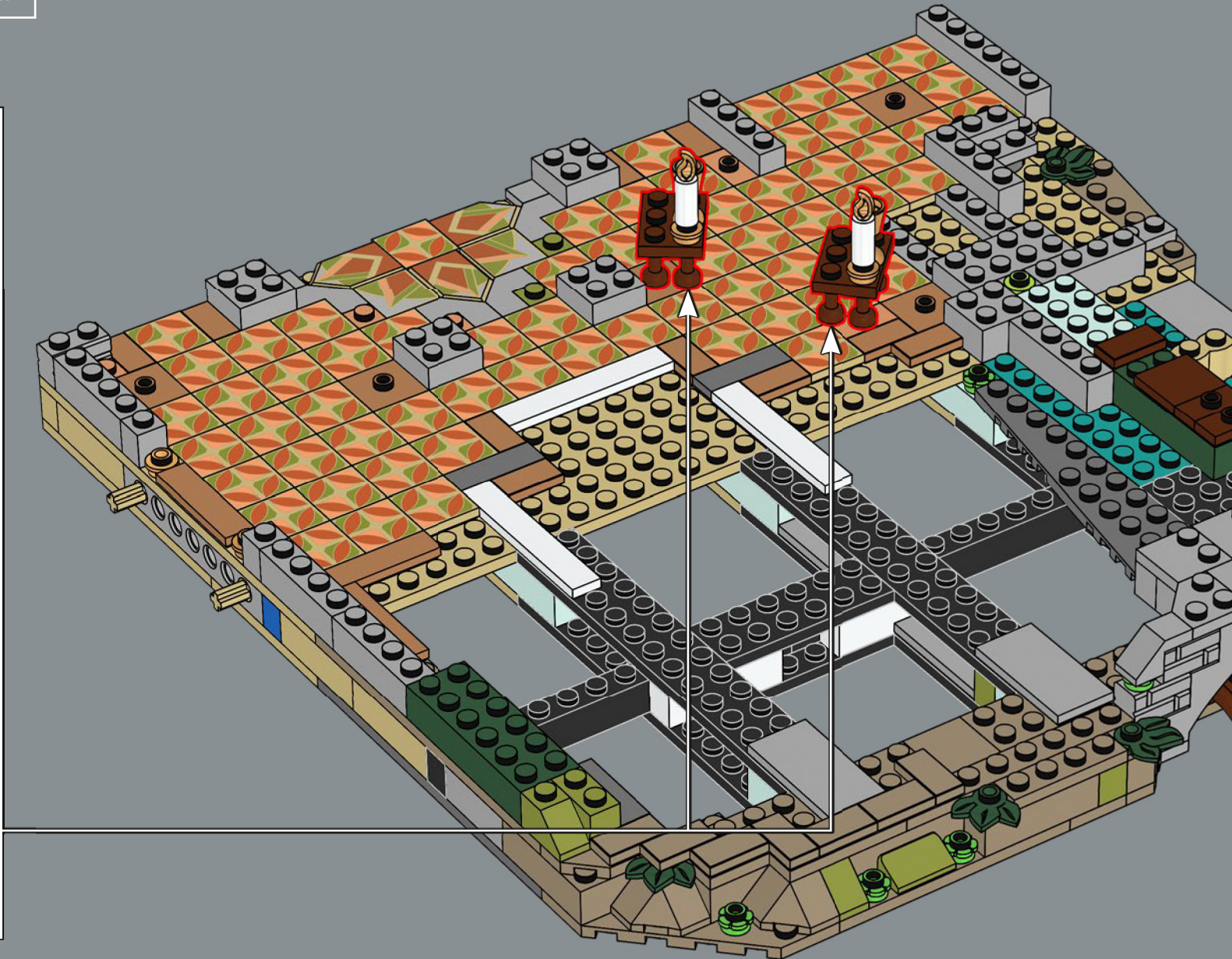

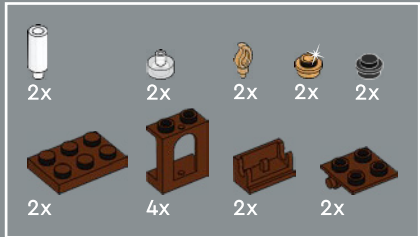

57

1

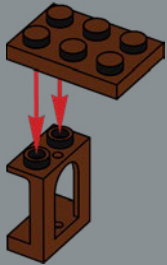

2

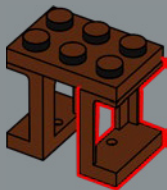

3



4



5



6



2x



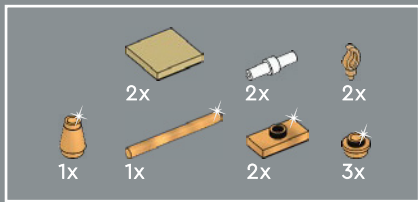

58

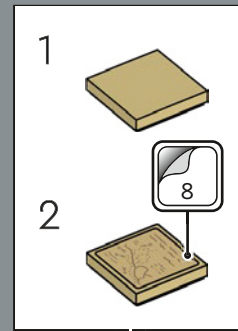
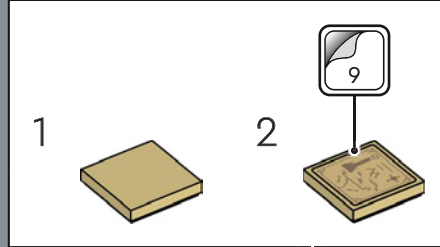
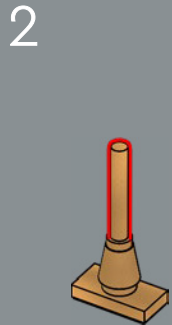
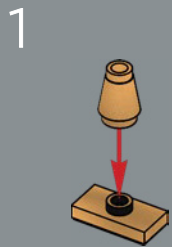
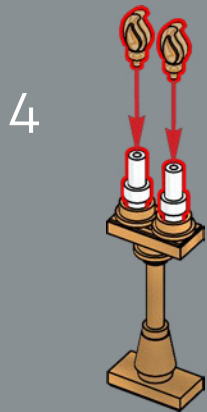
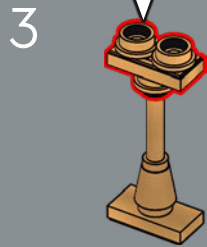
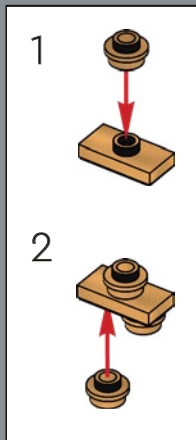

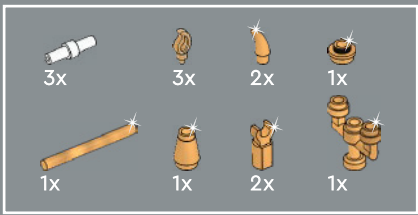

59

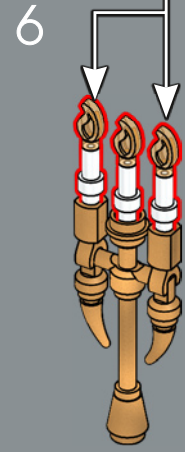
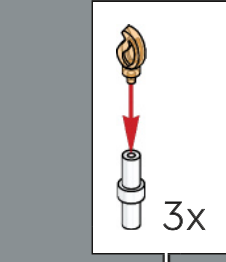
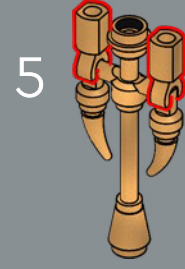
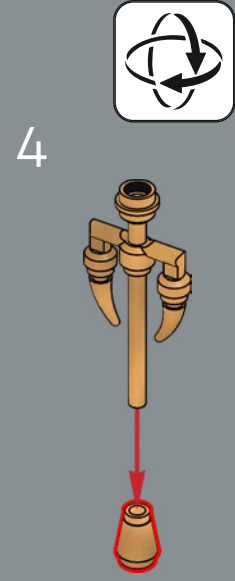
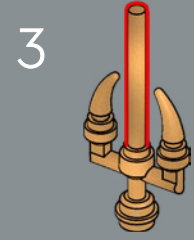
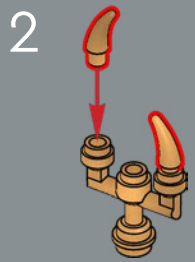
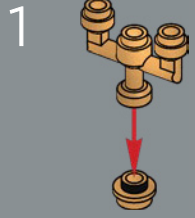

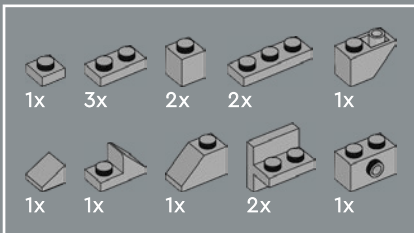
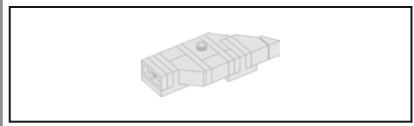

60

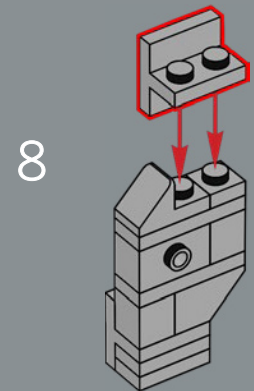
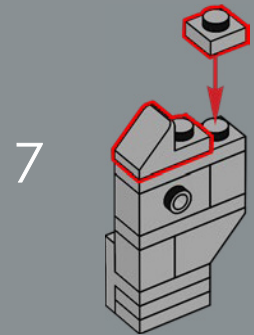
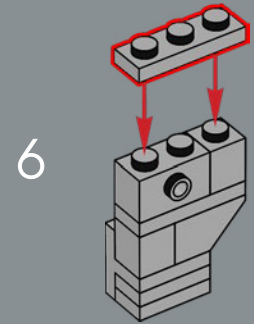
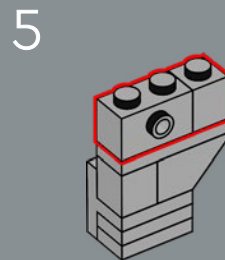
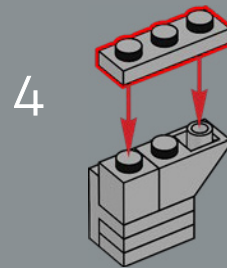
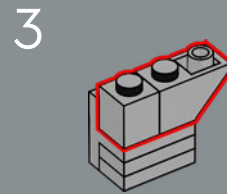
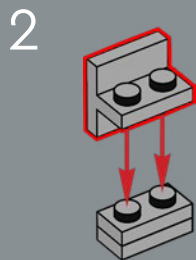
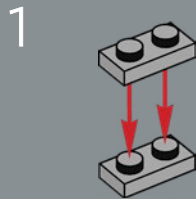

9

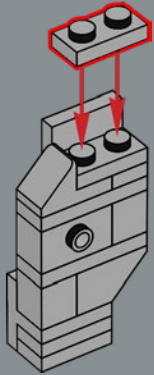

10

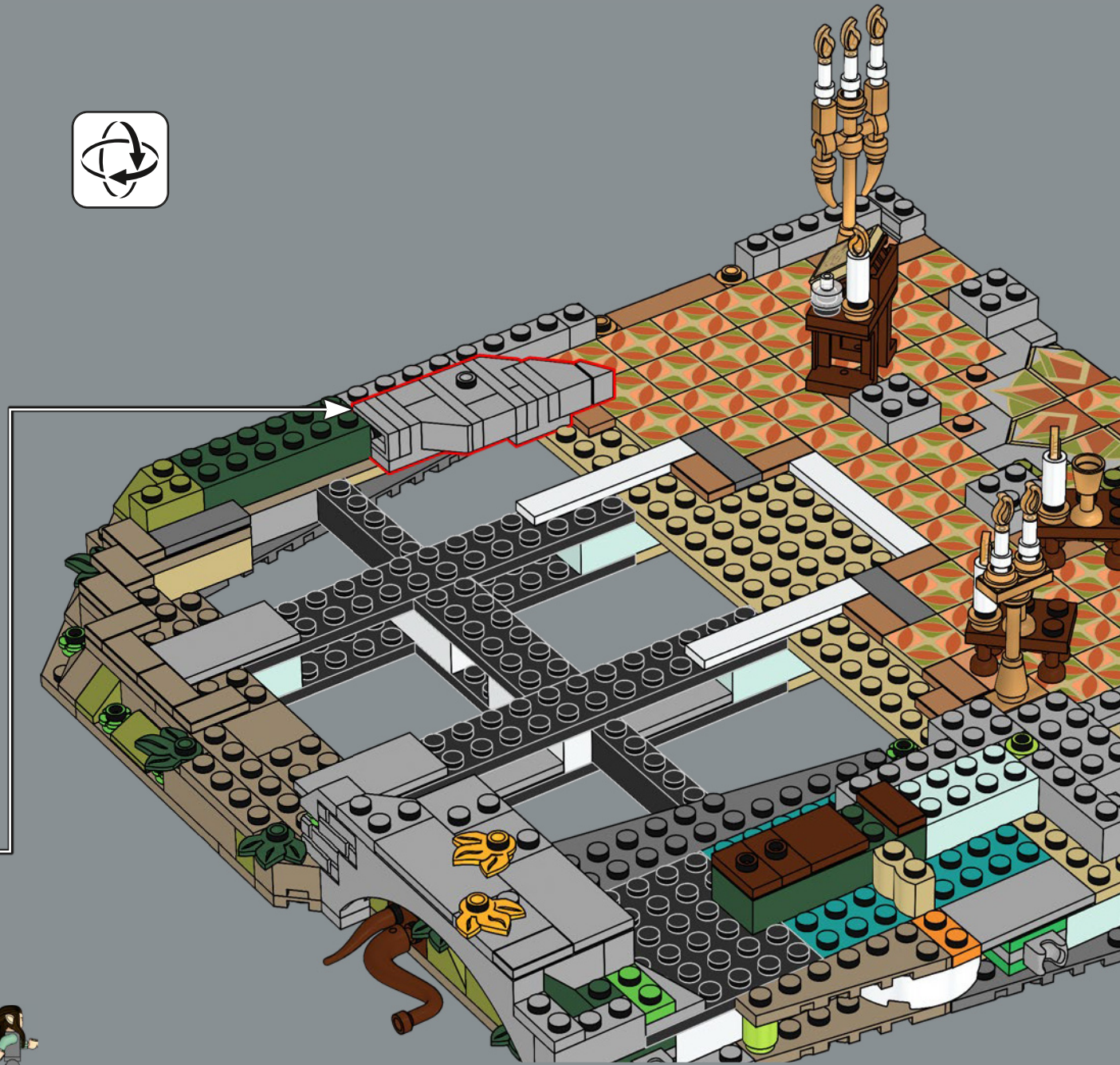
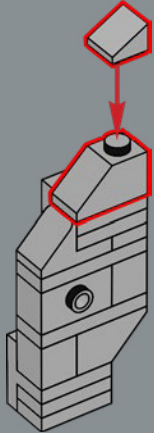

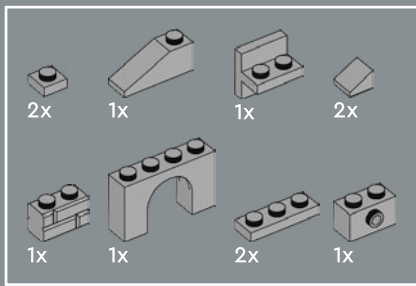

61

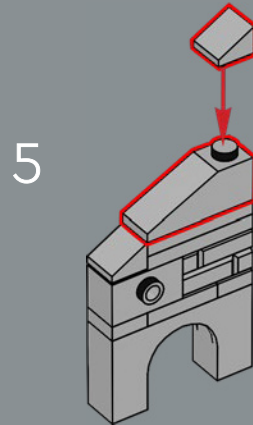
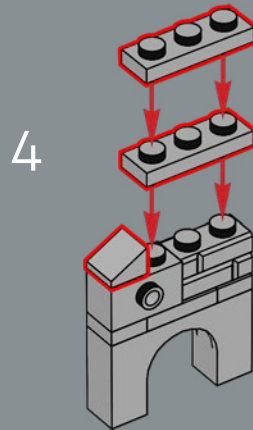
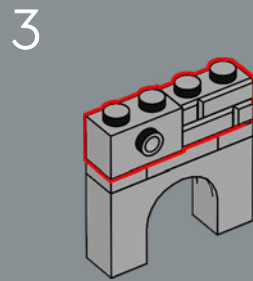
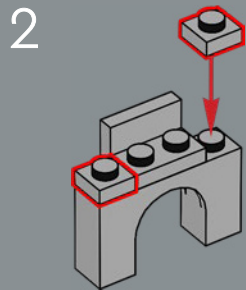
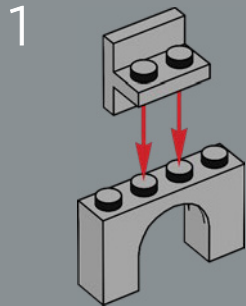

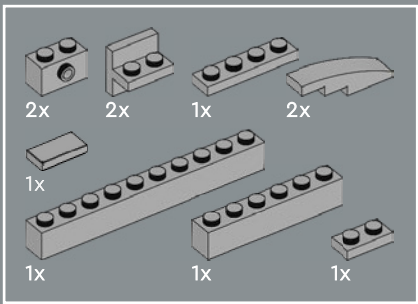

62

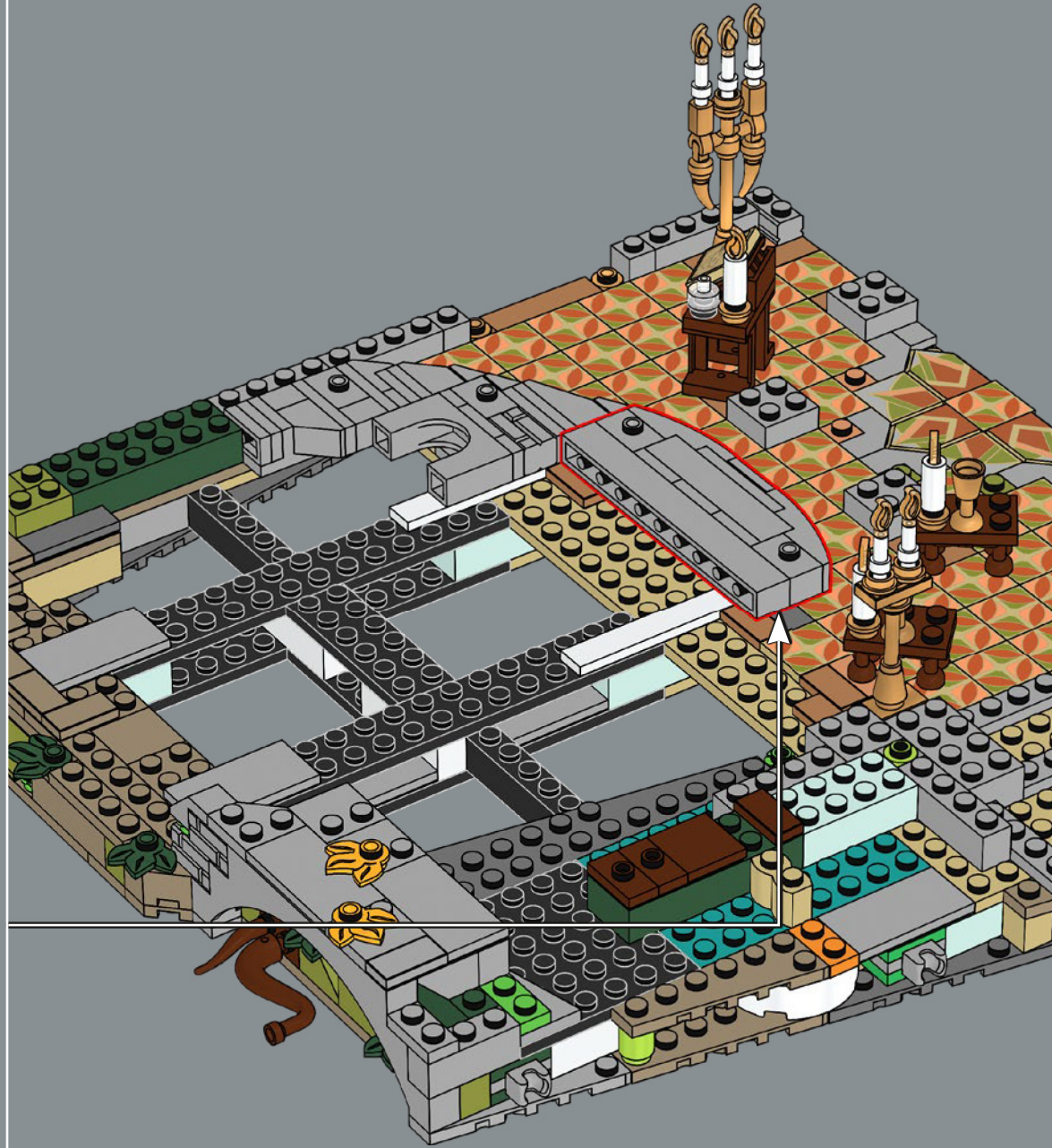
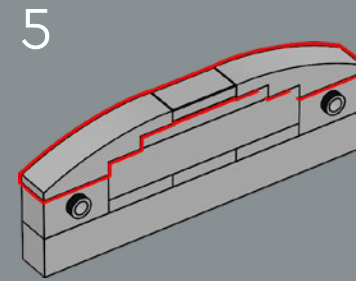
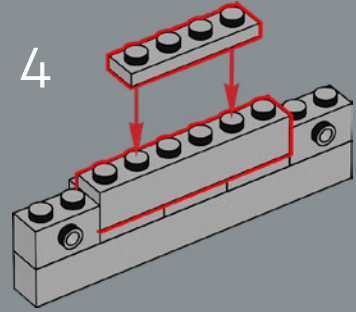
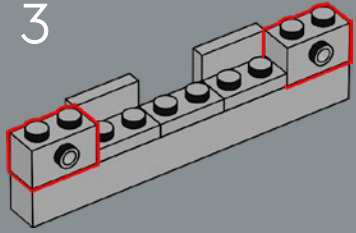
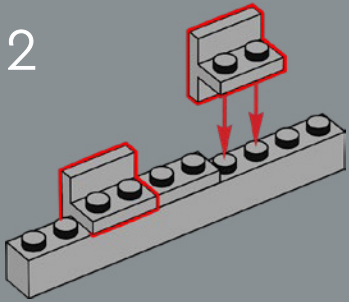
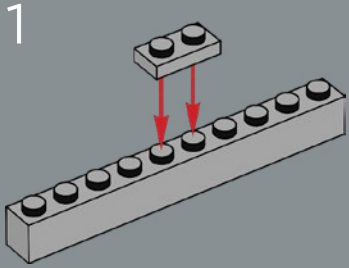

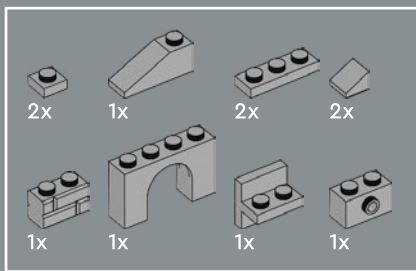

63

1

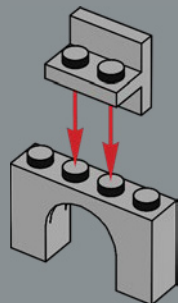

2

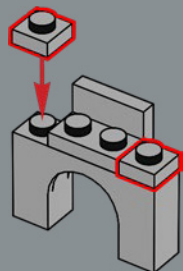

3

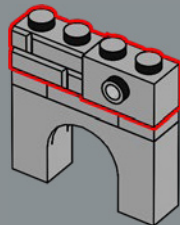

4

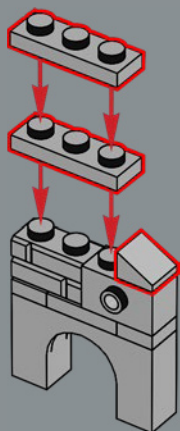

5

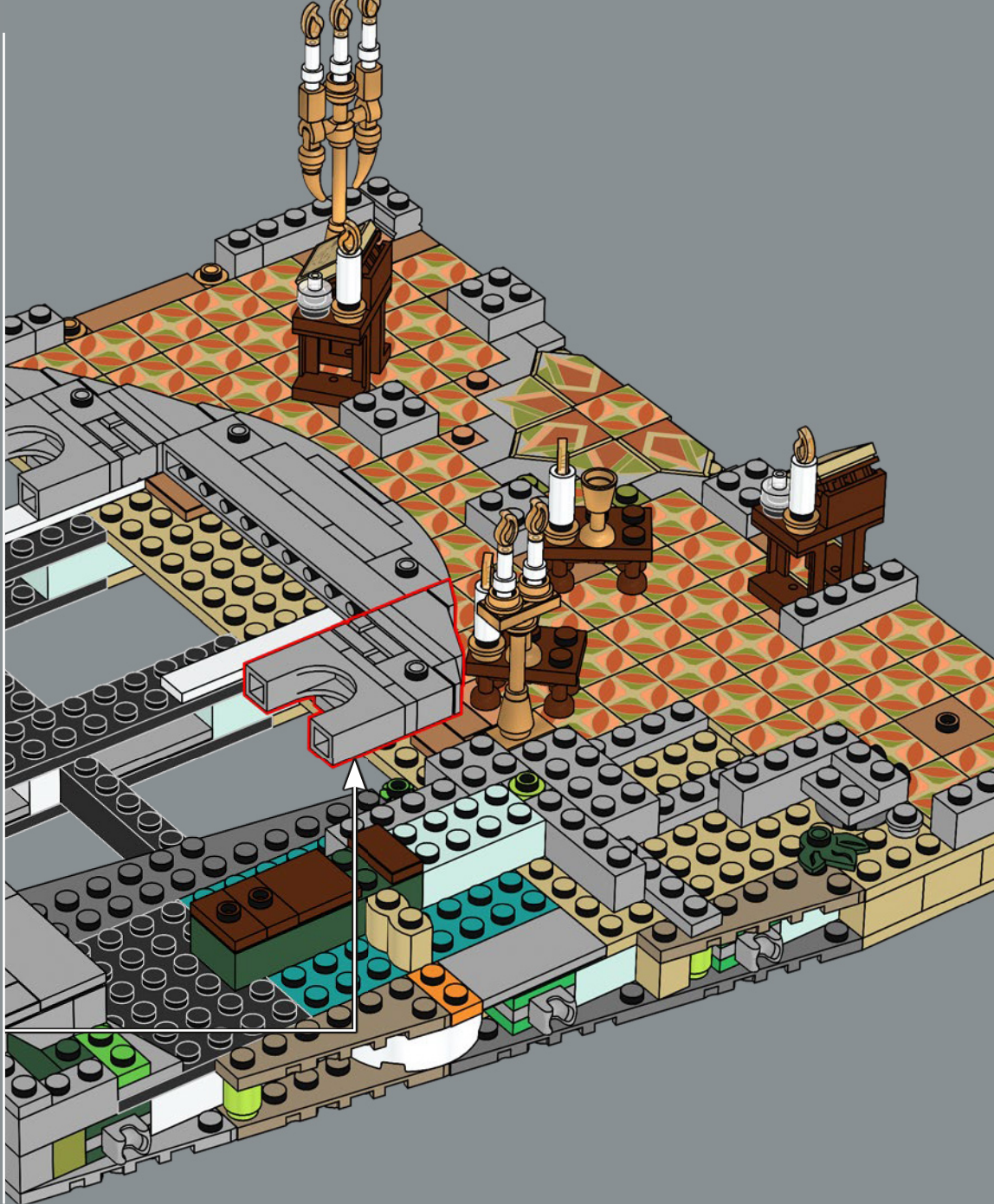
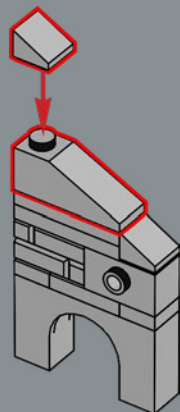

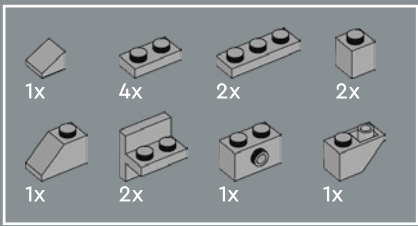

64

1

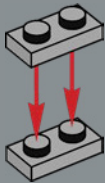

2

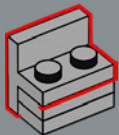

3

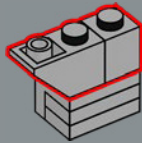

4

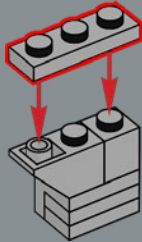

5

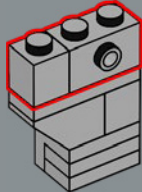

6

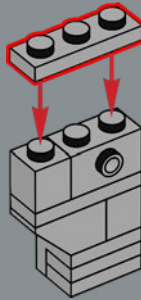

7

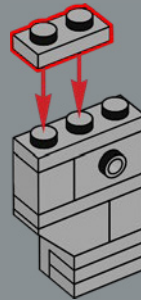

8

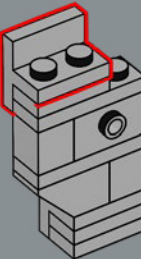

9

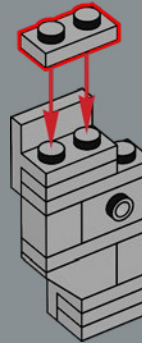

10

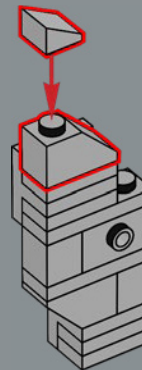



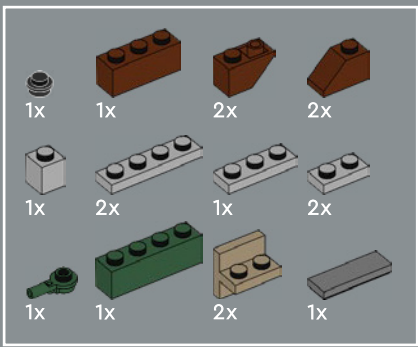

65

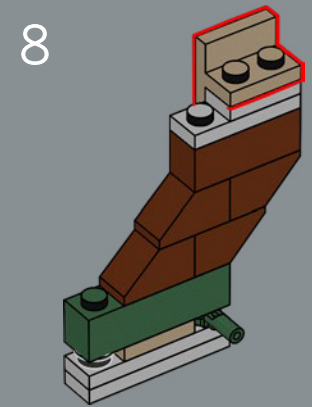
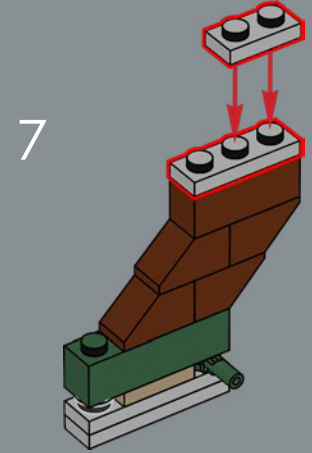
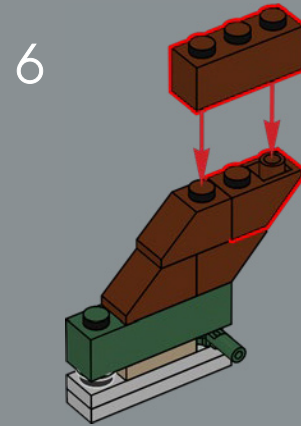
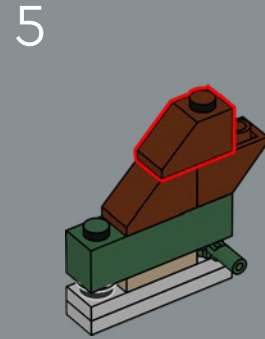
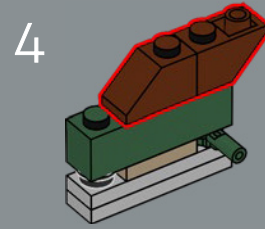
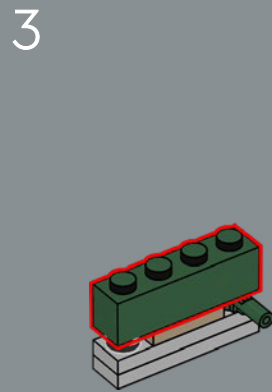
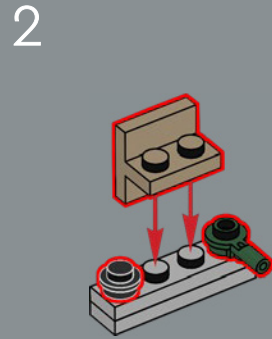
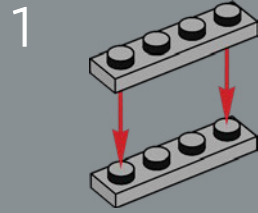

9

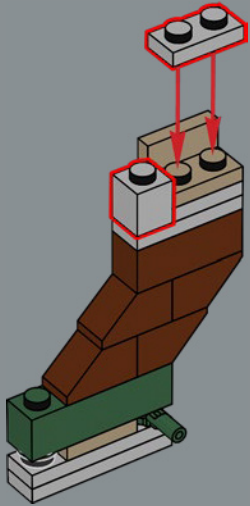

10

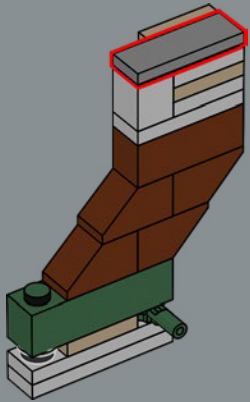

-  1x
-  4x
-  1x
-  2x
-  3x

66

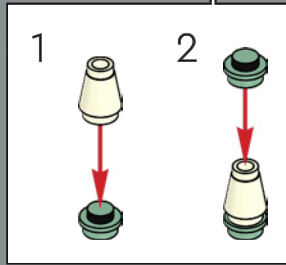
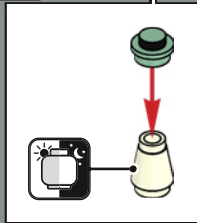
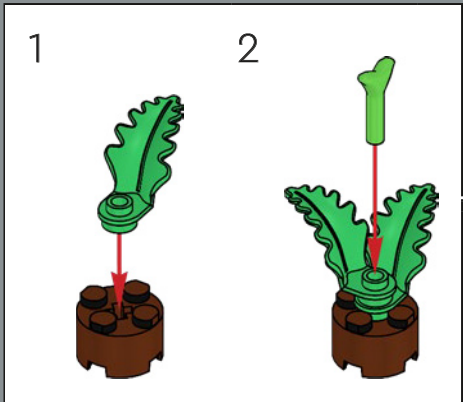
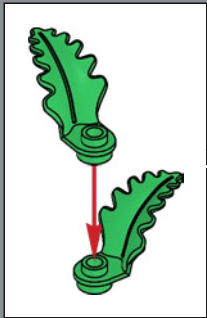

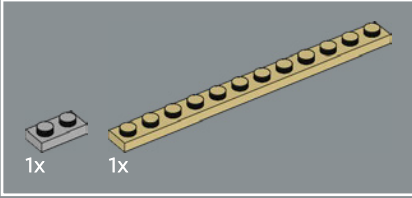
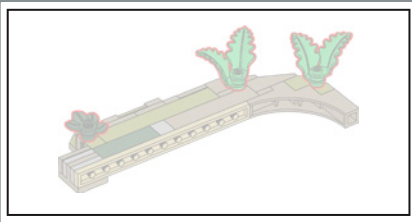

67

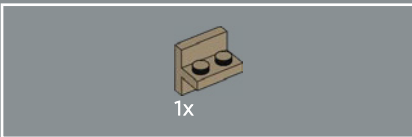
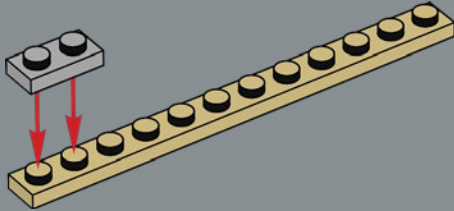

68

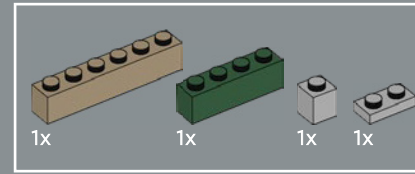
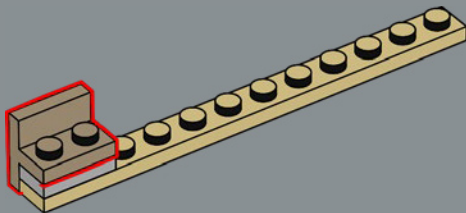

69

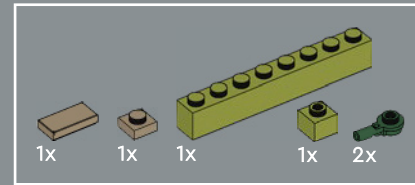
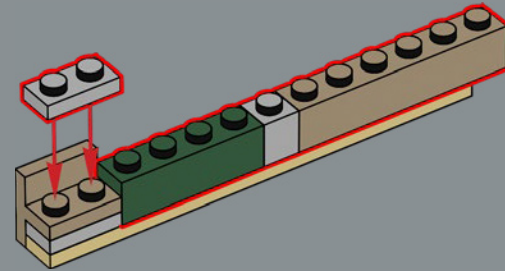

70

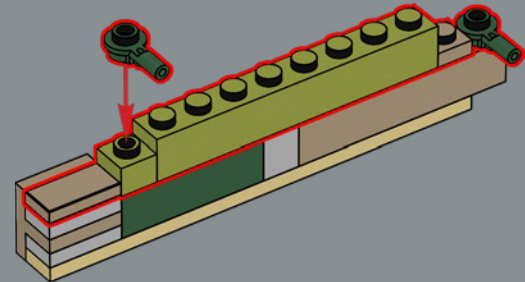

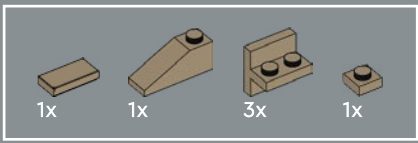

71

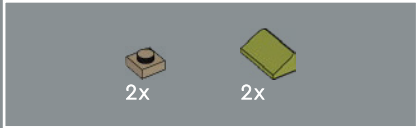
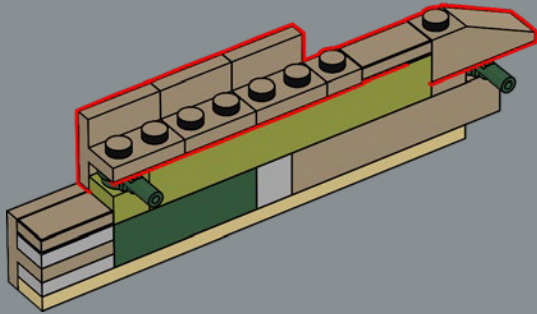

72

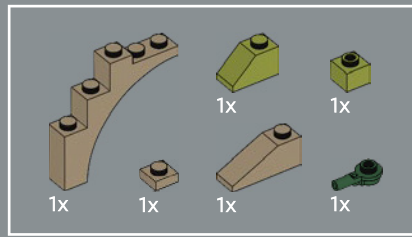
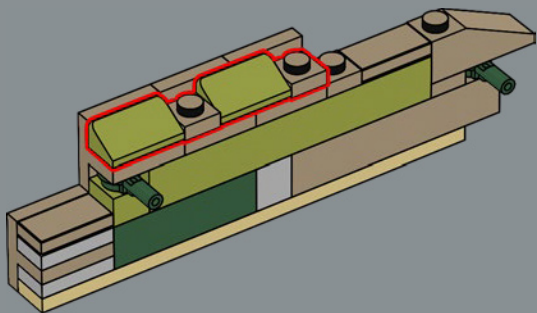

73

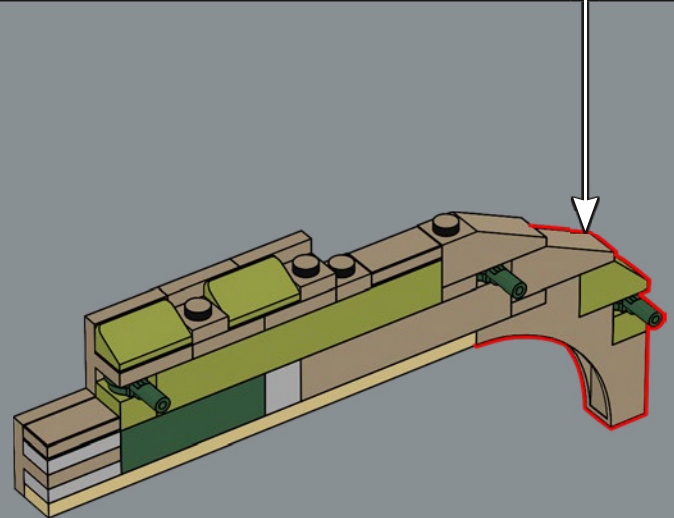
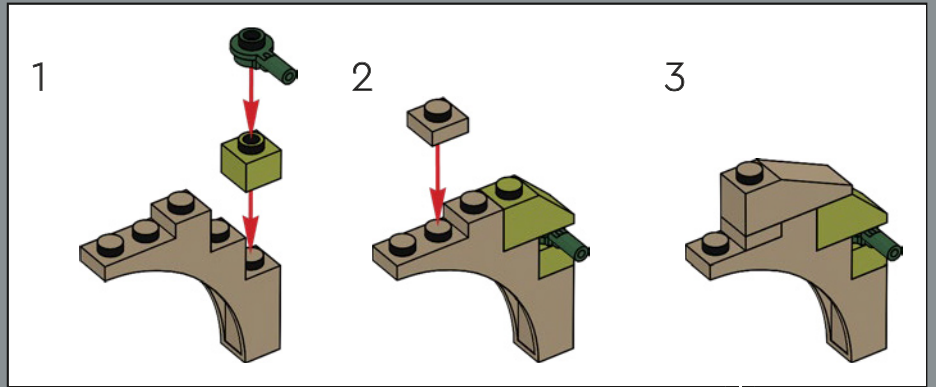



74

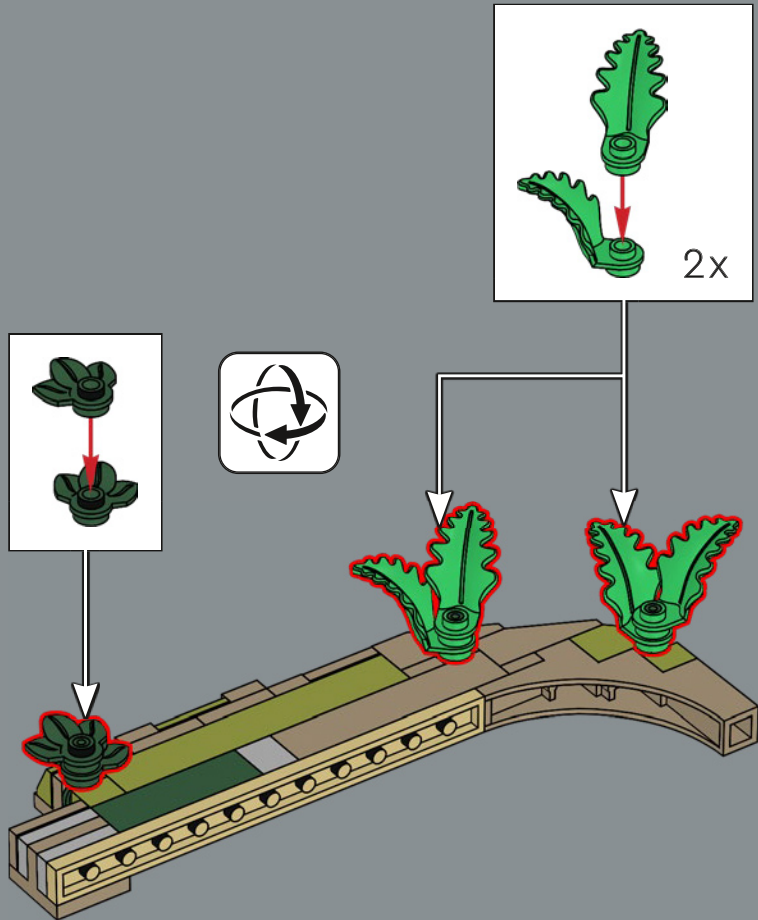

75



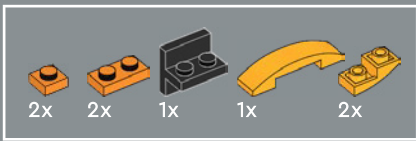

Dieses Element trägt den zentralen Sockel der Ratsplattform.
Dieser Sockel behält den Ring immer im AUGE ...

76

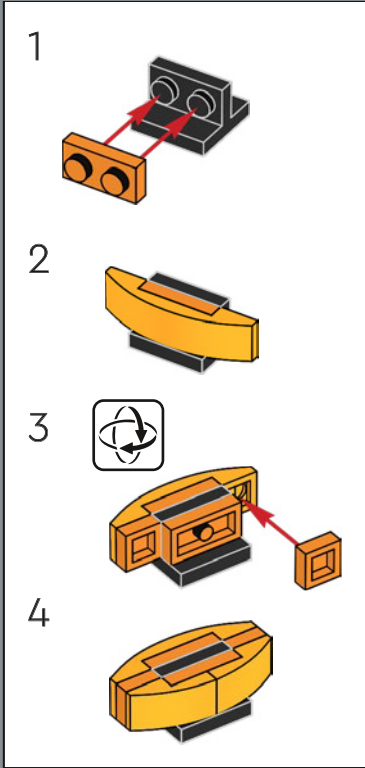

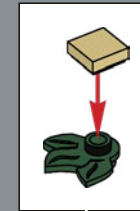
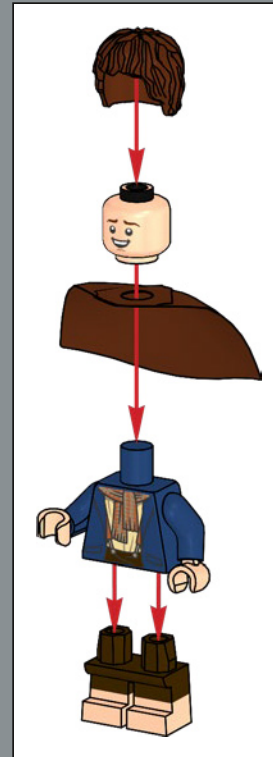
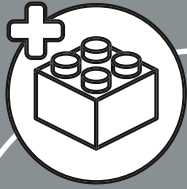

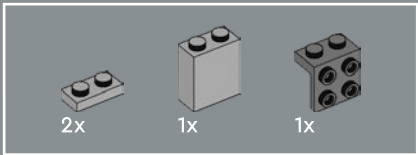

77

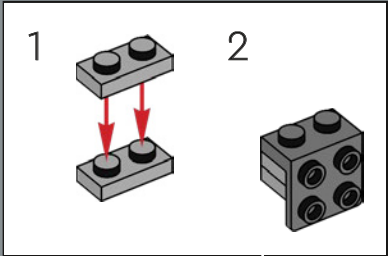

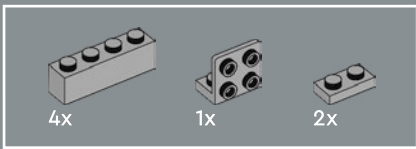

78

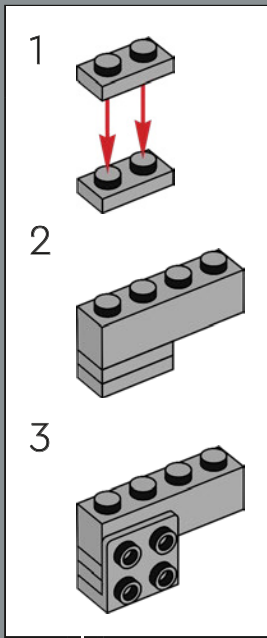
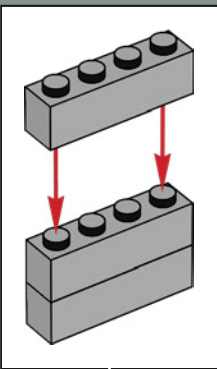

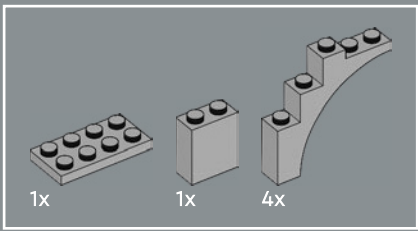

79

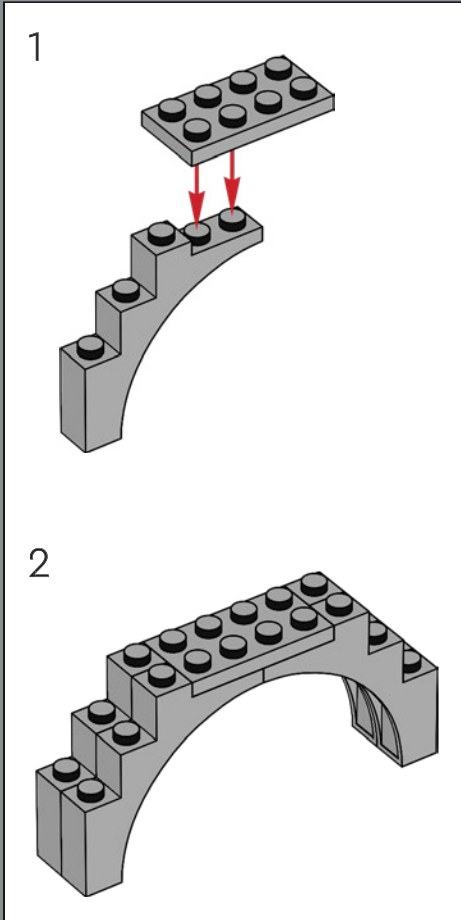
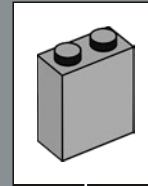

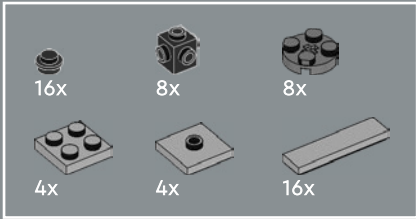

80

1

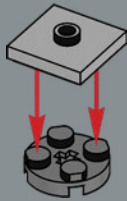

2

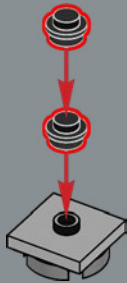

3

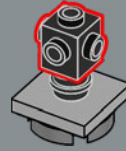

4

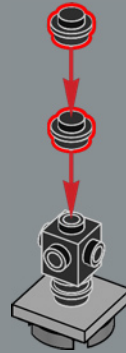

5

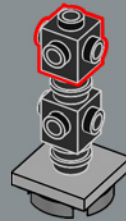

6

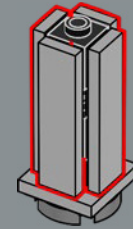

7

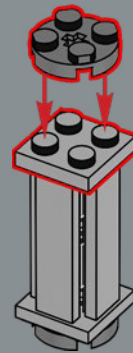

4X



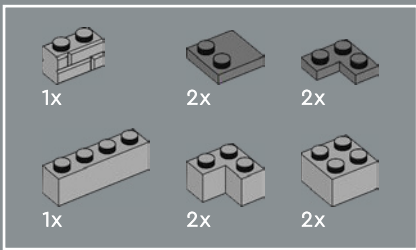

81

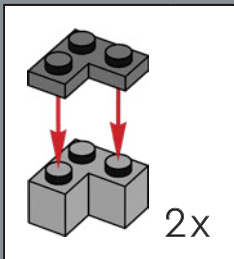
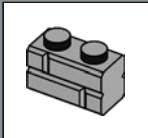
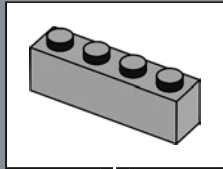
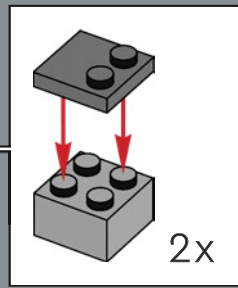

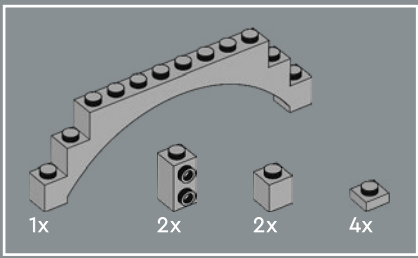

82

1

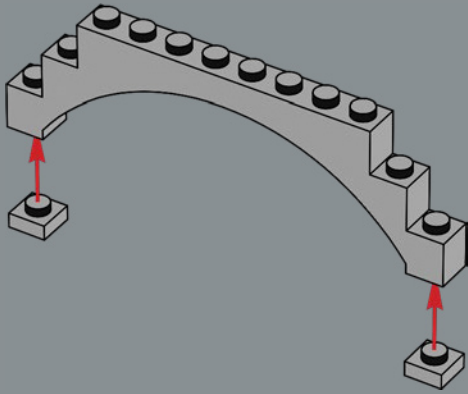

2

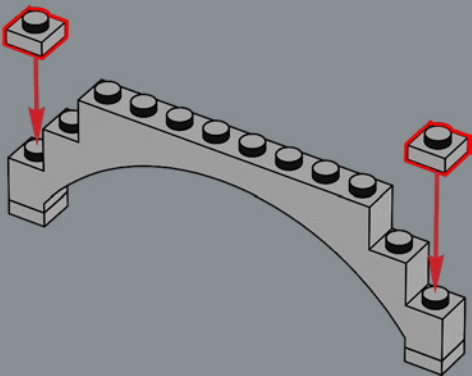

3

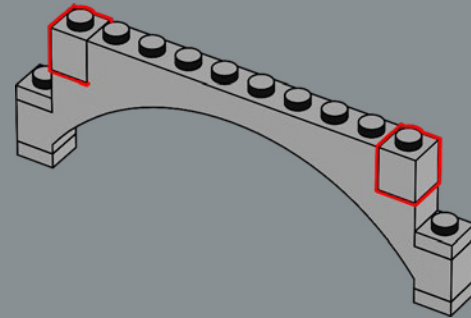

4

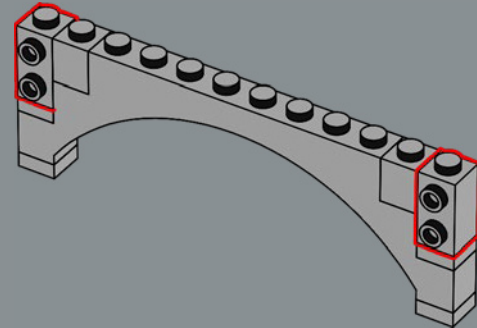



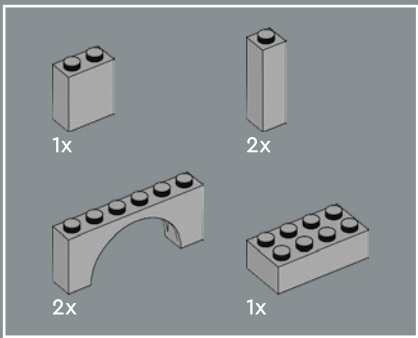

83

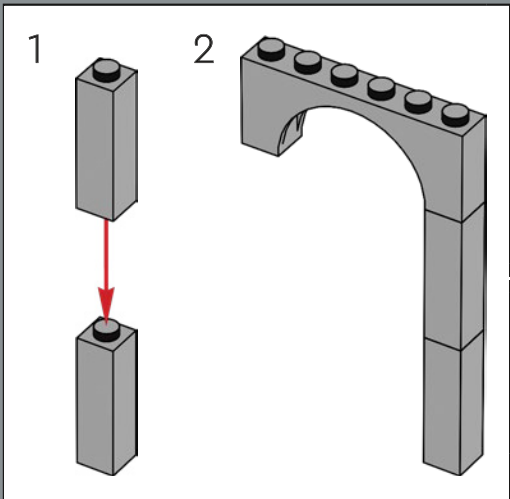

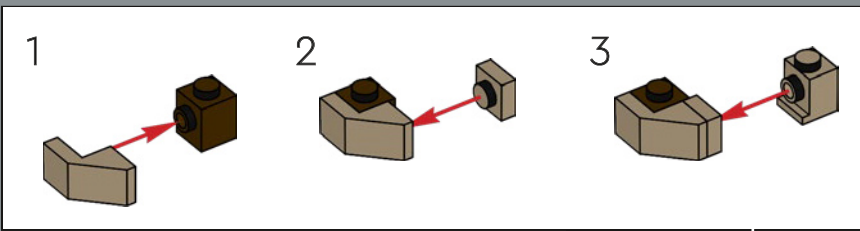
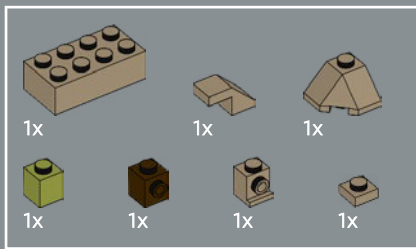

84



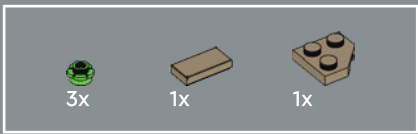

85

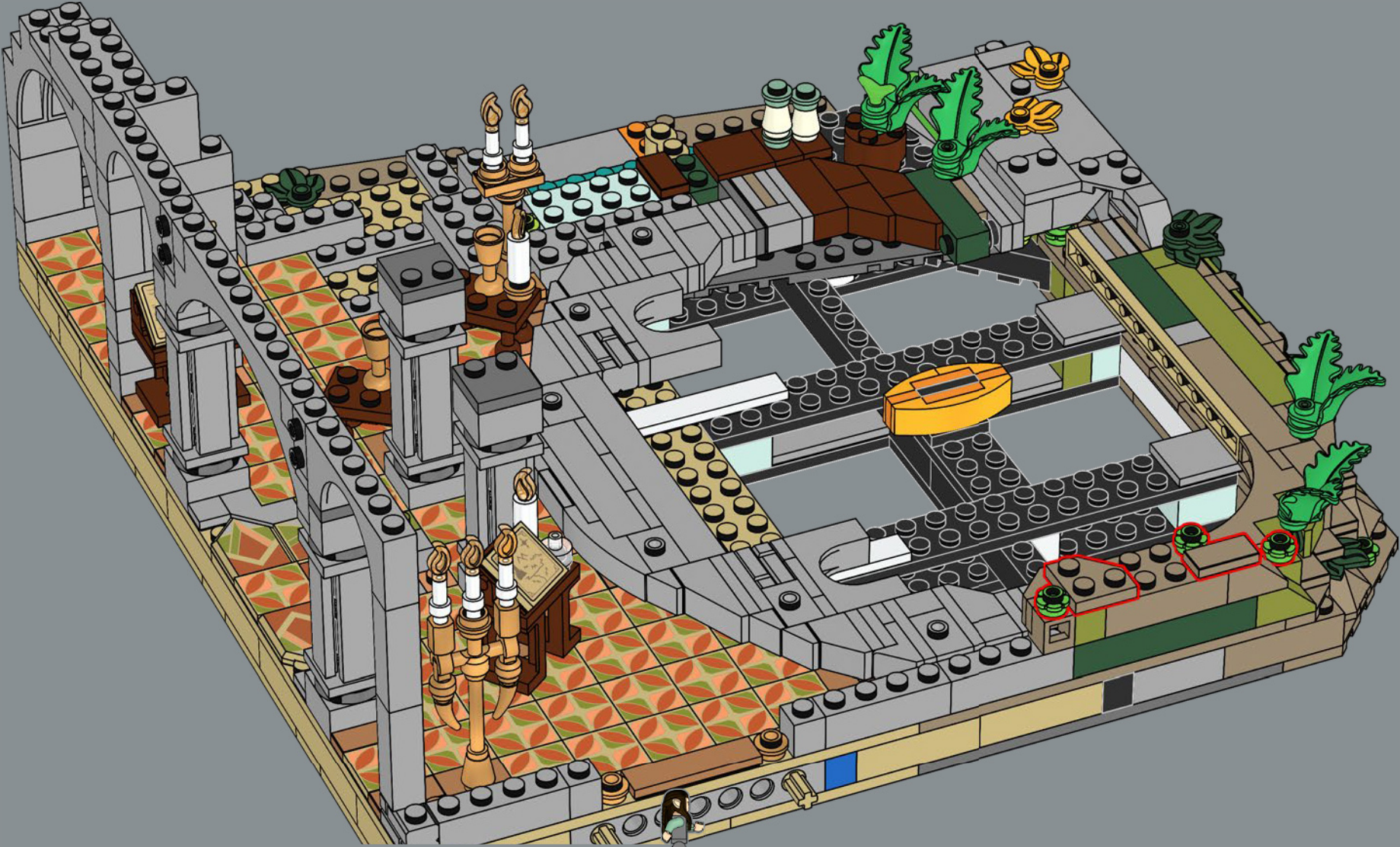

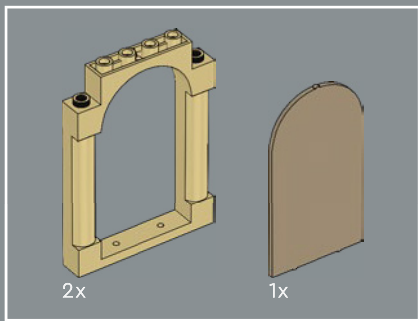

86

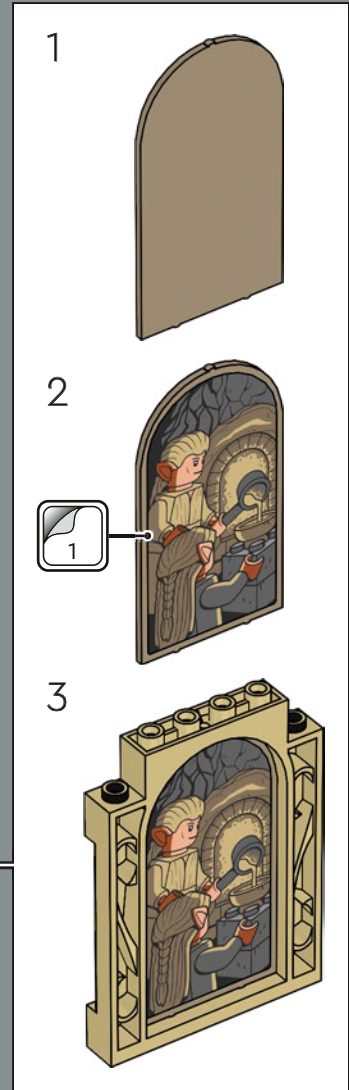

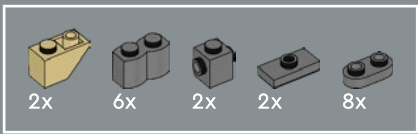

87

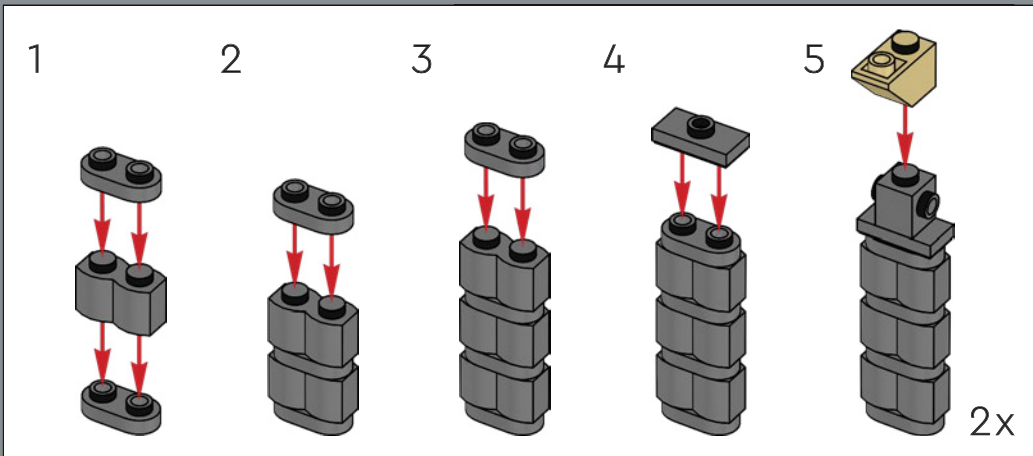
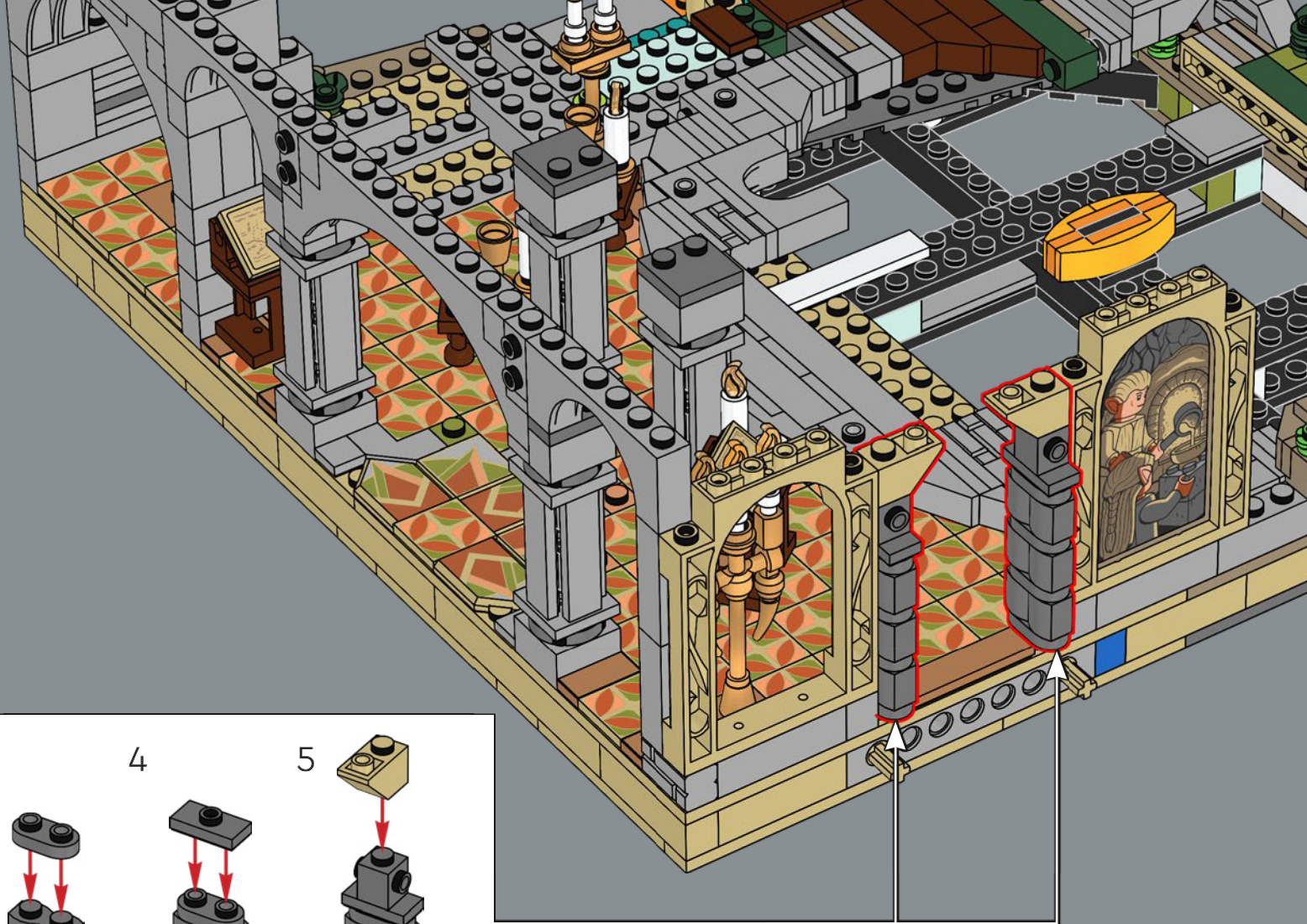

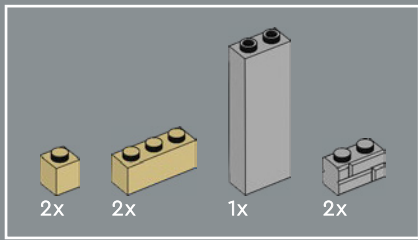

88

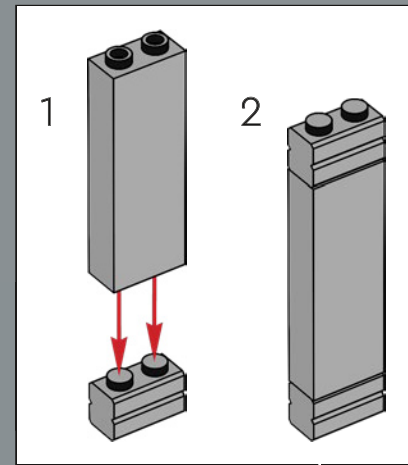

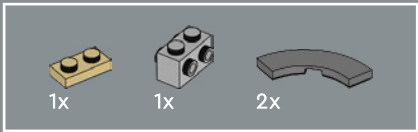

89

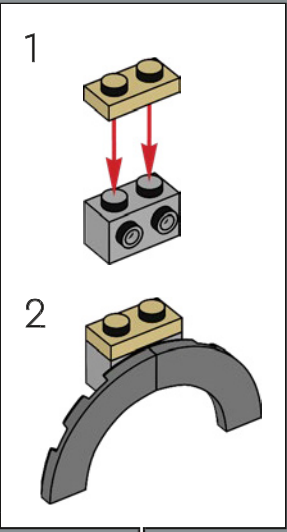

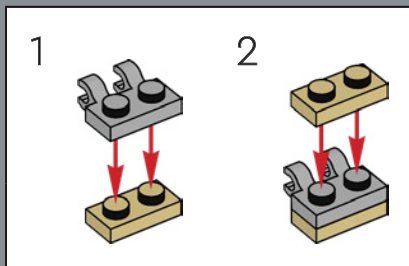
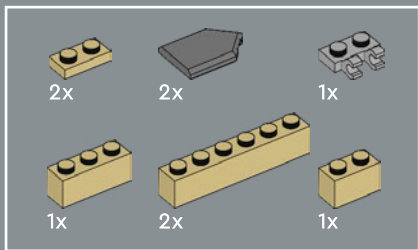

90



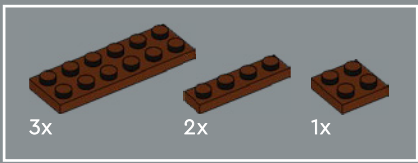

91



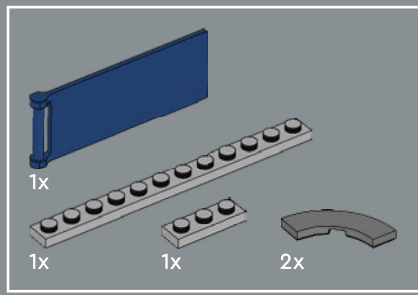

92

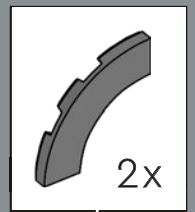
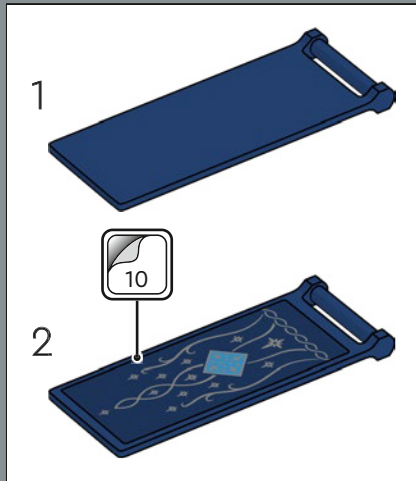



4x

93

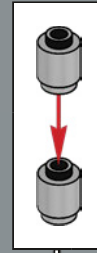

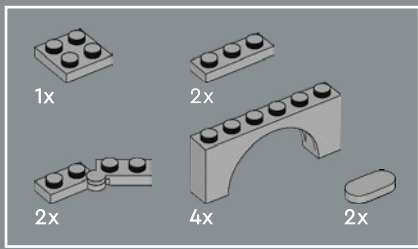

94

1

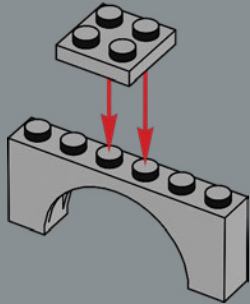

2

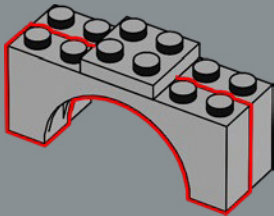

3

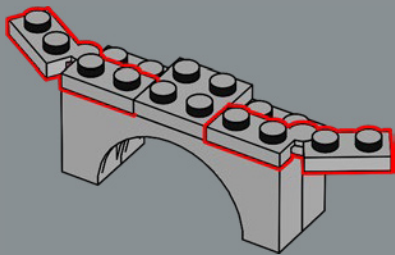

4

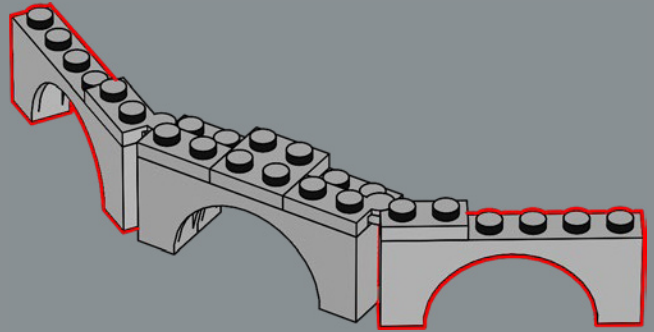

5

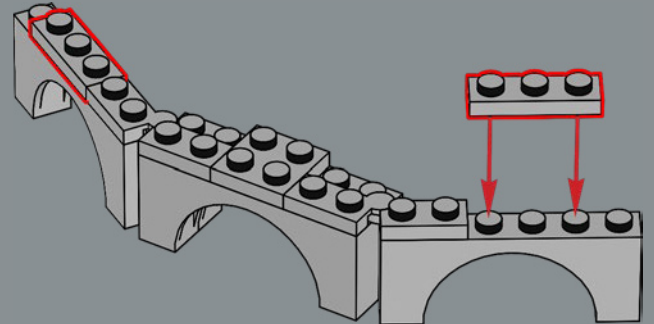

6

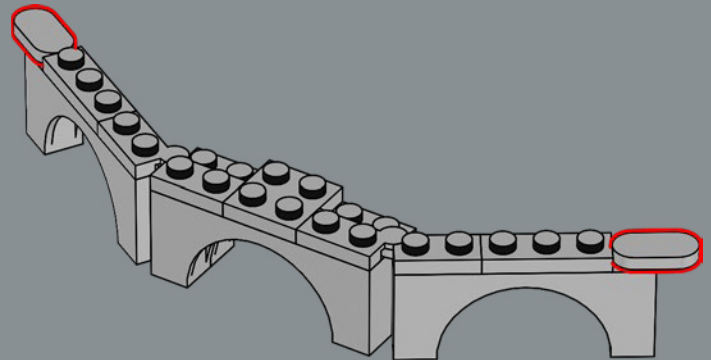



Die Dreiecke für dieses obere Segment bilden pythagoreische Paare. Bei dieser Bautechnik teilen sich zwei ungleiche Dreiecke eine Hypotenuse gleicher Länge.





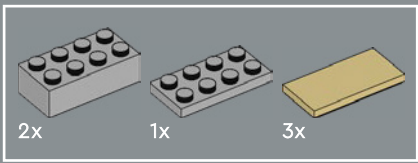

95

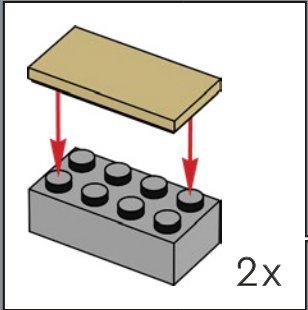
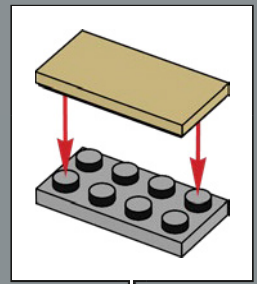

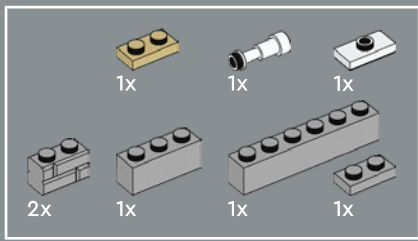

96

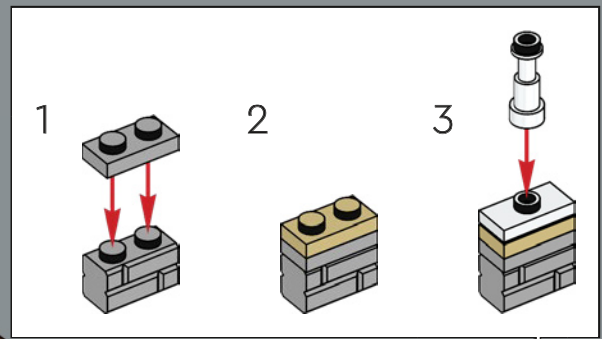

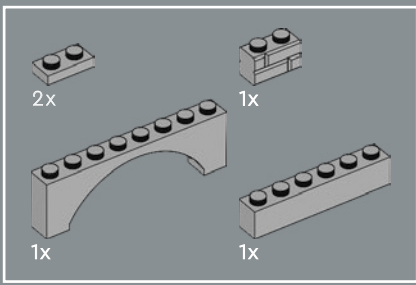



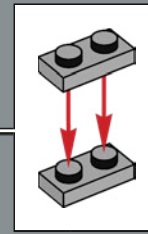

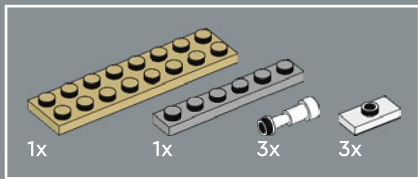

97

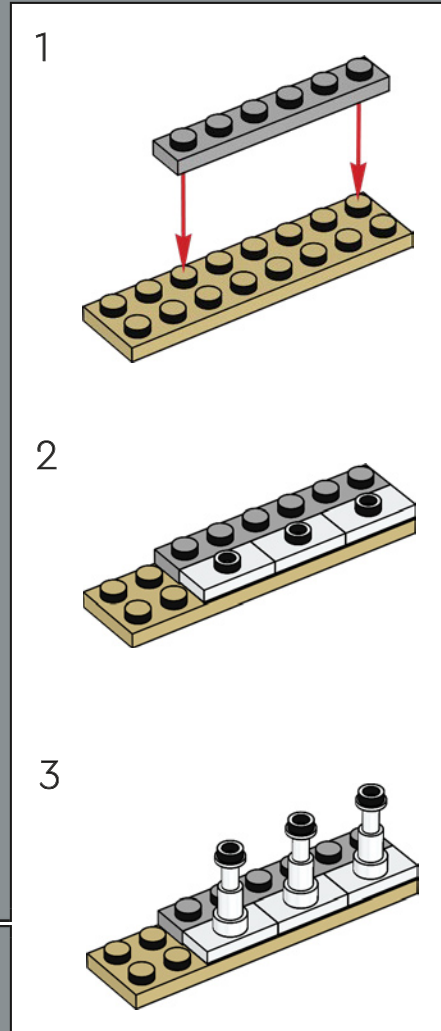



98



- 2x 
- 1x 
- 1x 
- 3x 
- 1x 
- 1x 

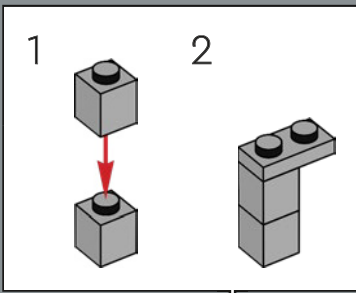

99

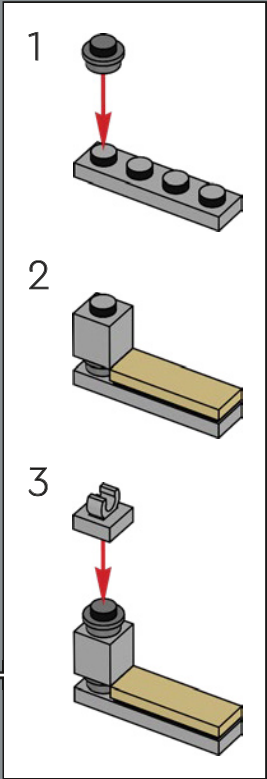

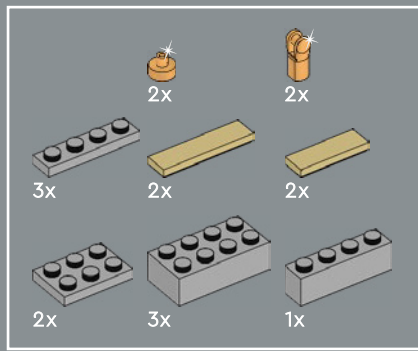

100

1

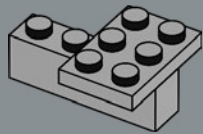

2

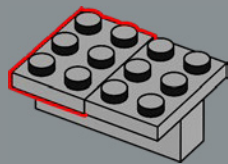

3

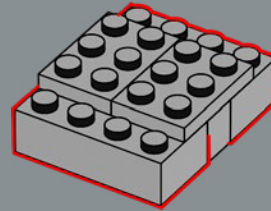

4

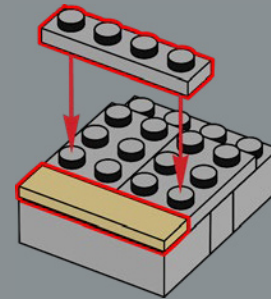

5

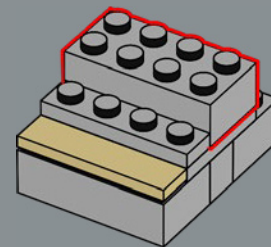

6

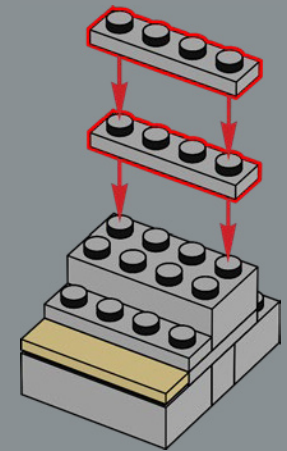

7

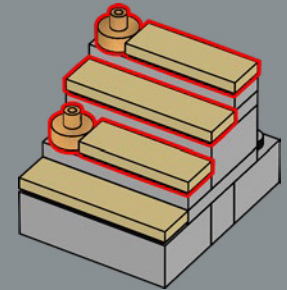

8

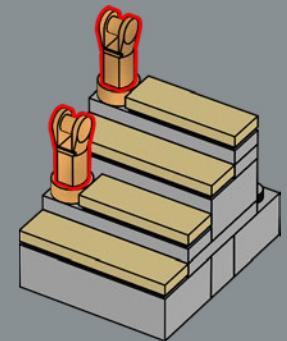



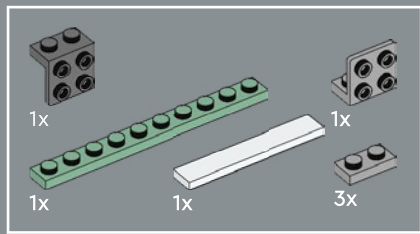

101

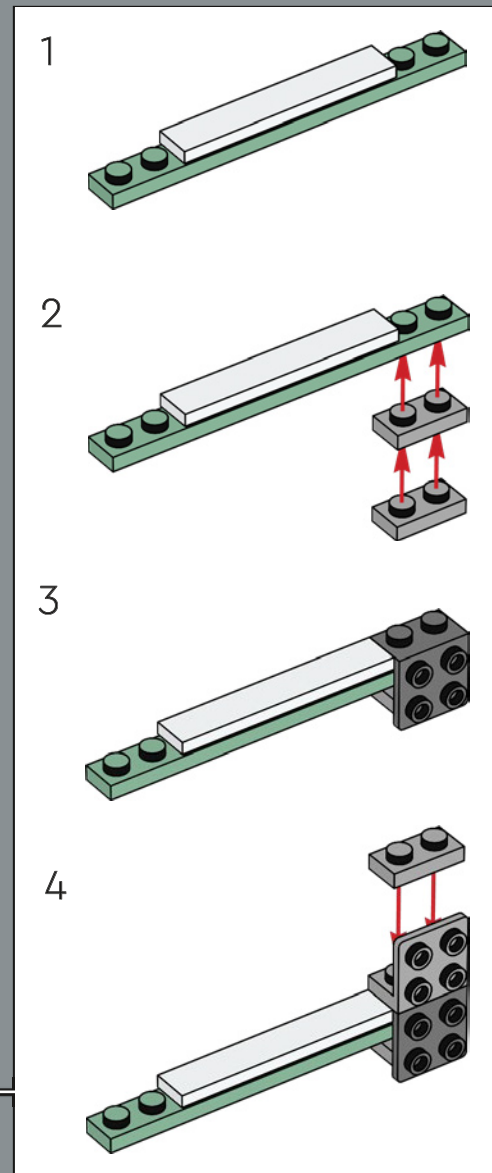

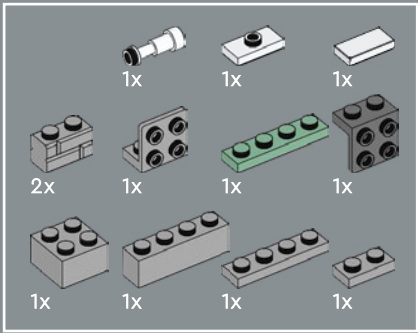

102

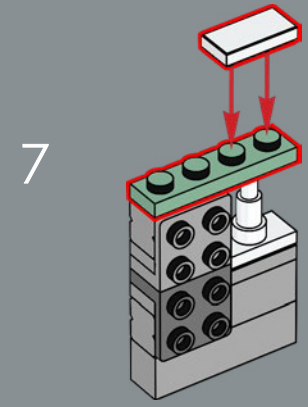
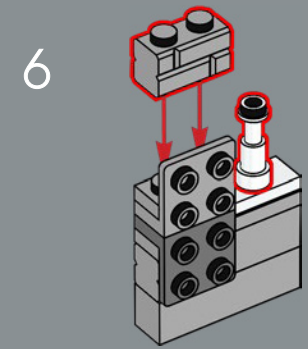
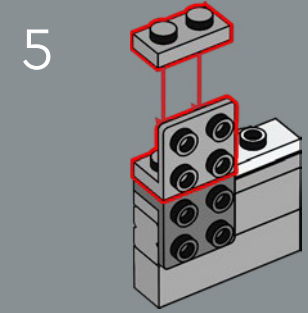
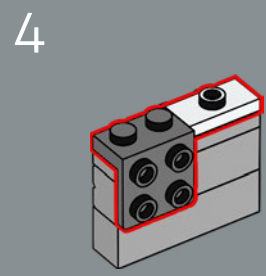
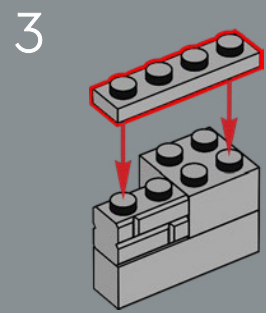
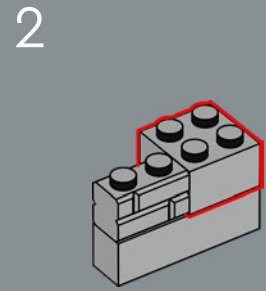
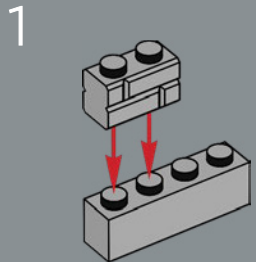



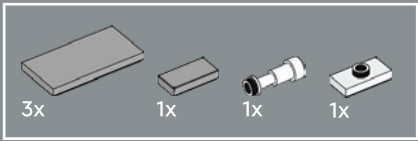

103

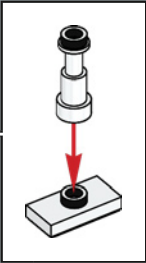

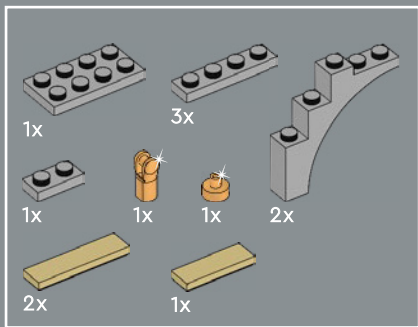

104

1

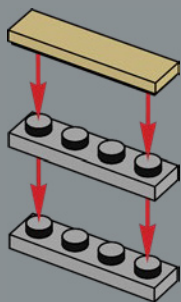

2

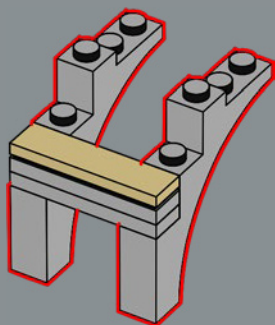

3

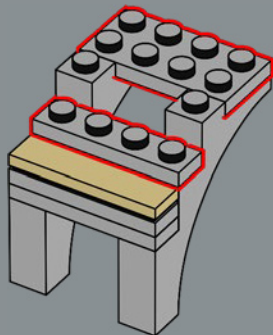

4

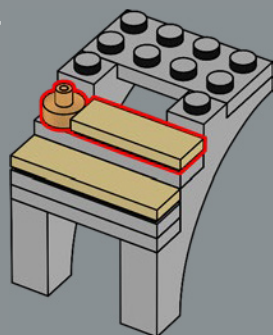

1



2

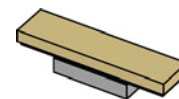

5

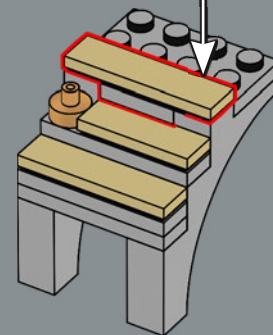

6

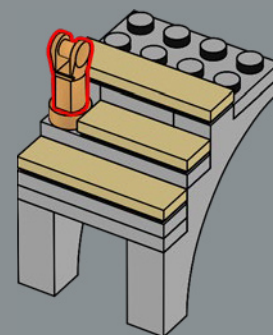



Da diese Treppe mit einem Geländer gesichert ist,
sind auf den Stufen keine Noppen erforderlich!



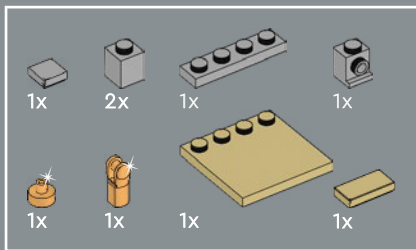

105

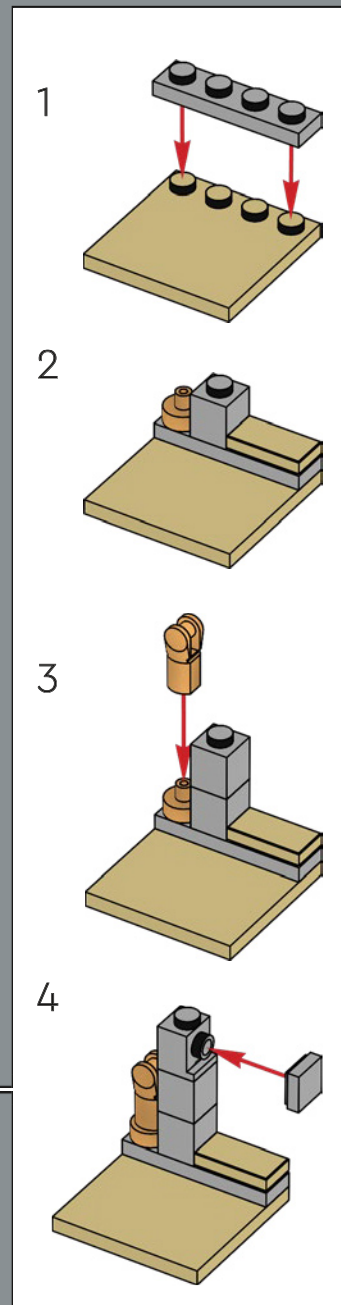
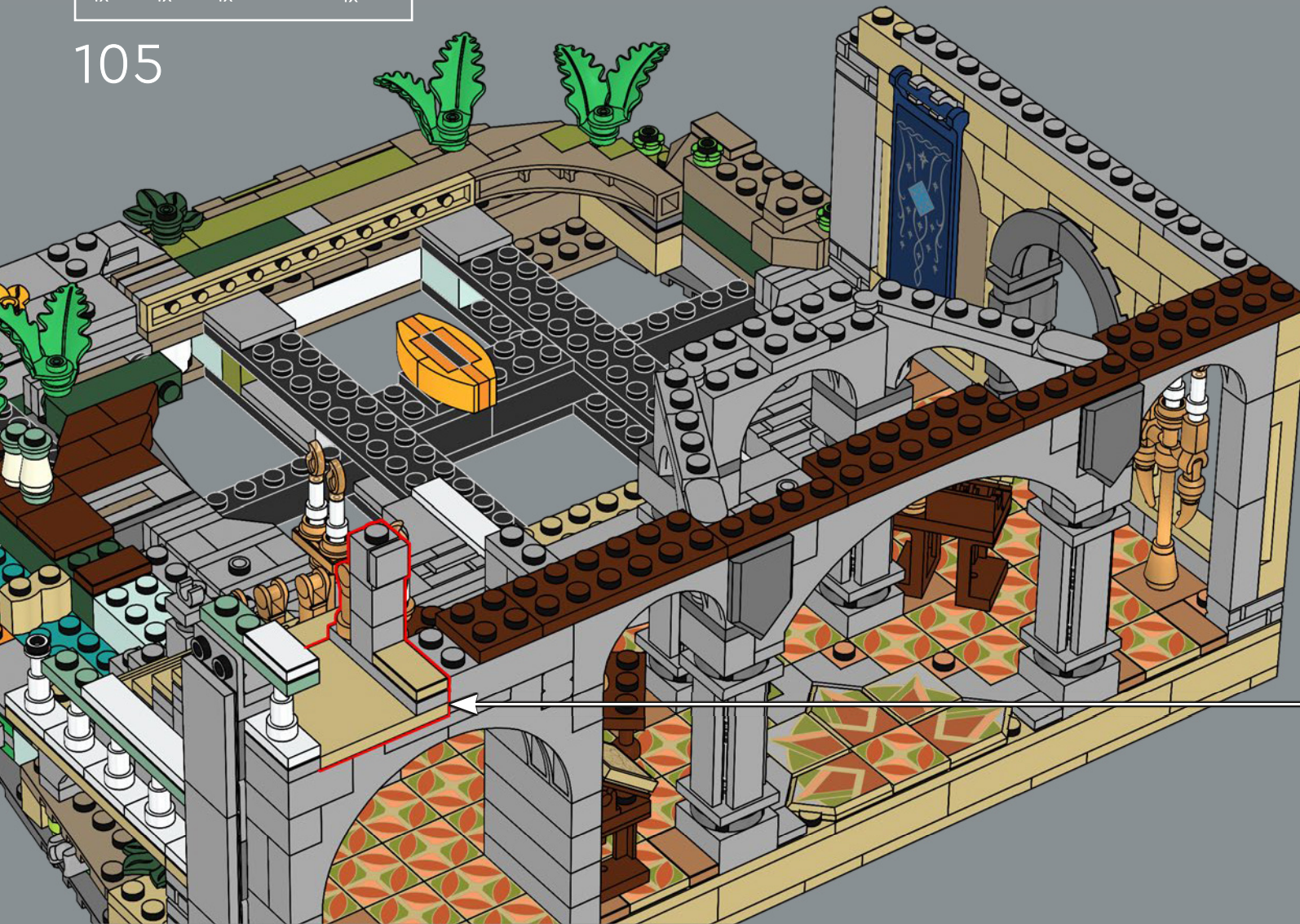

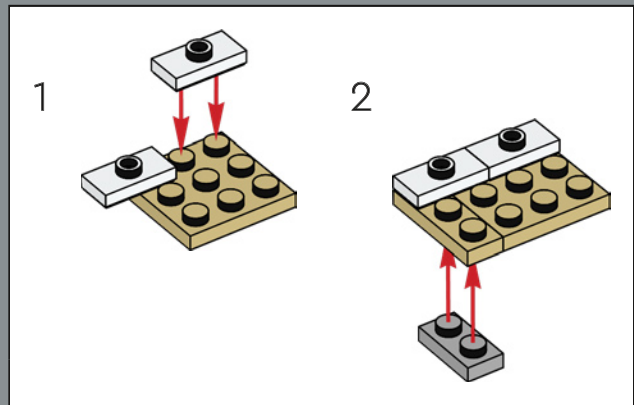
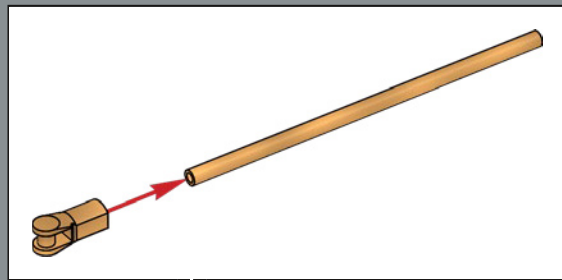
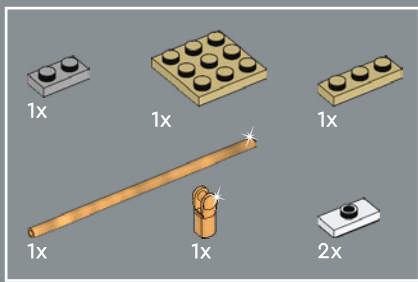

106

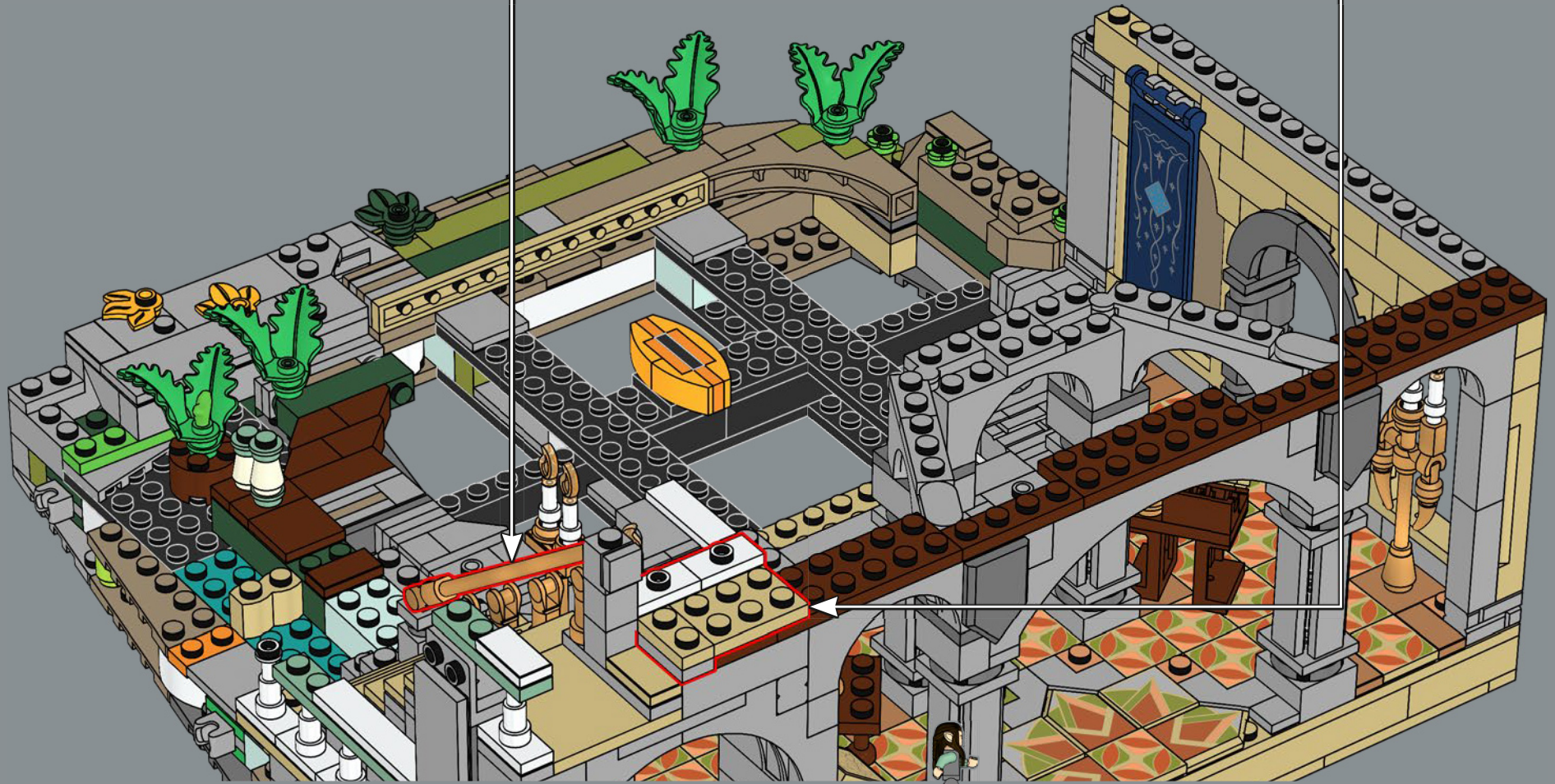

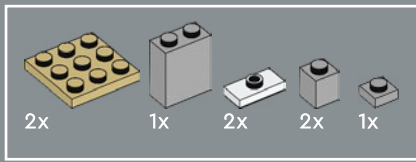

107

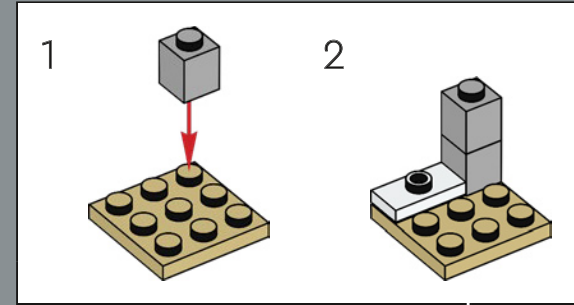
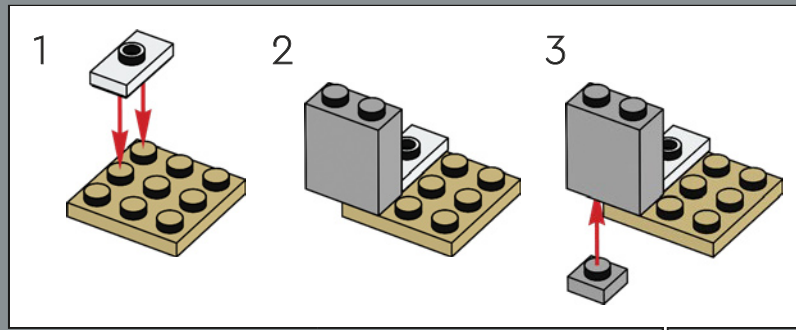

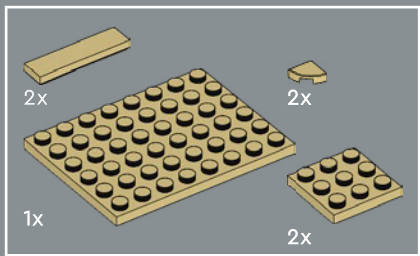

108



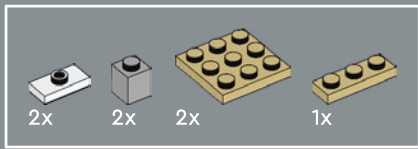

109

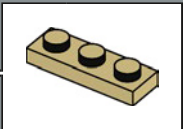
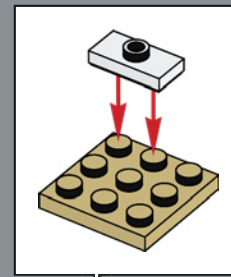
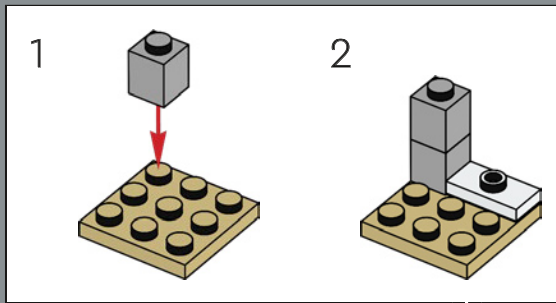

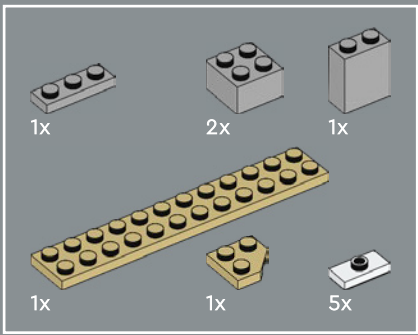

110

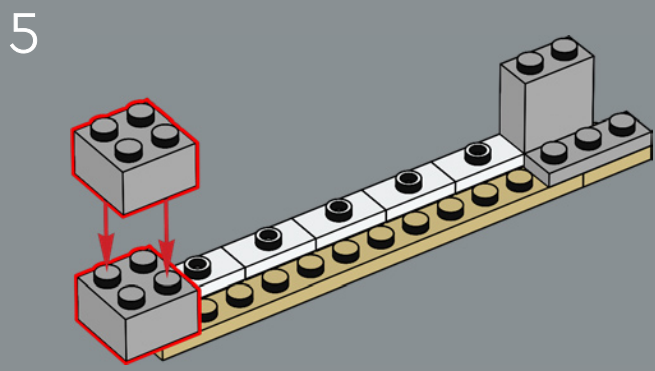
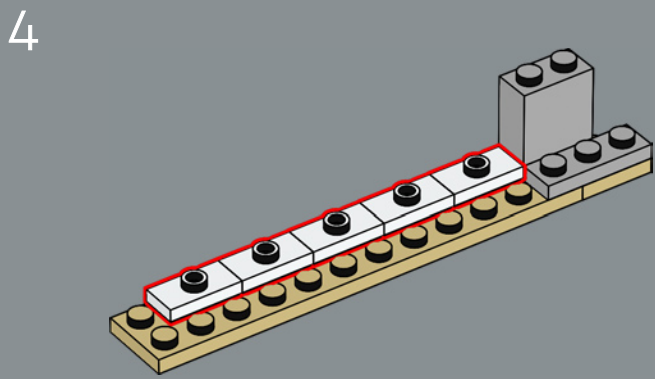
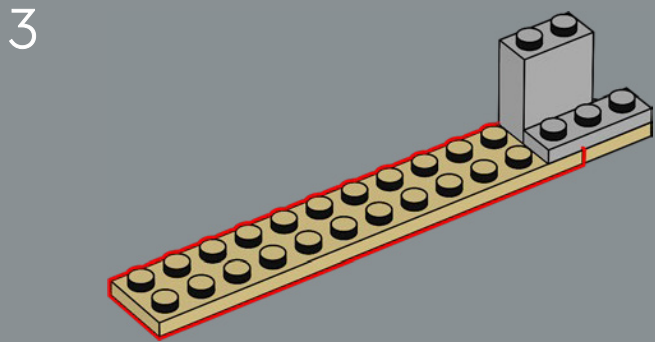
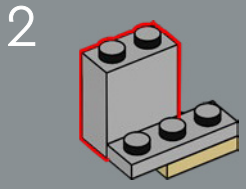
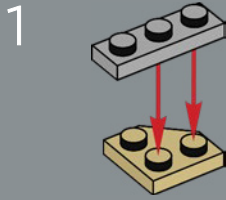



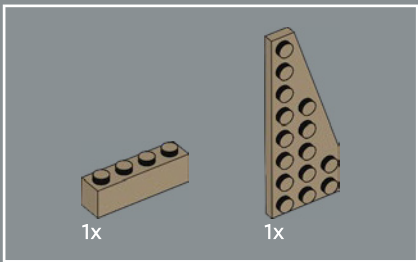
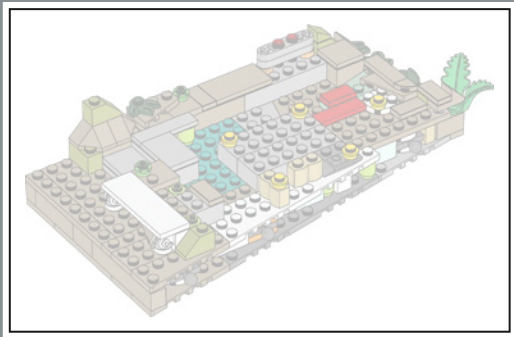

111

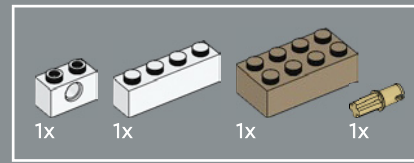
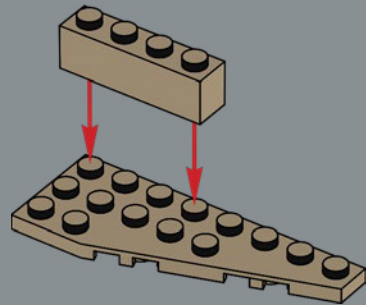

112

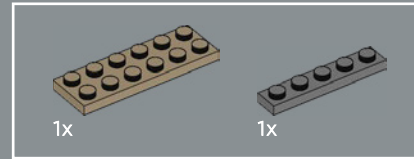
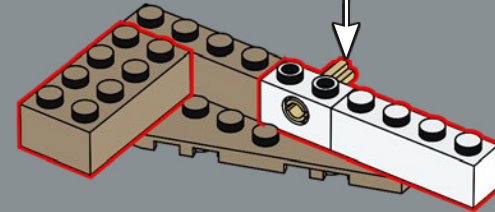
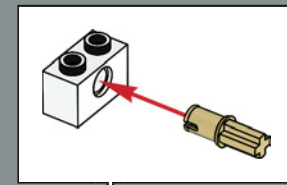

113

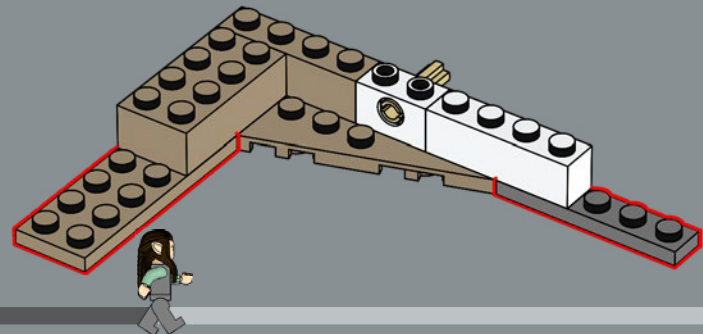

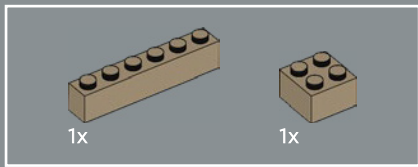

114

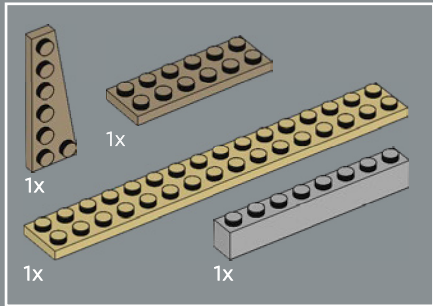
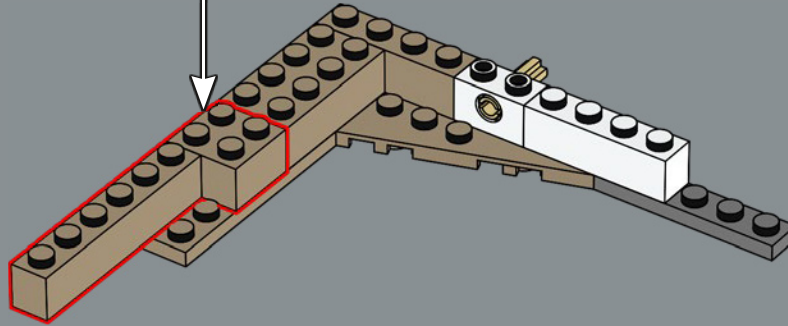
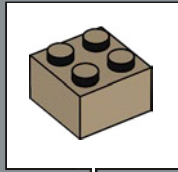

115

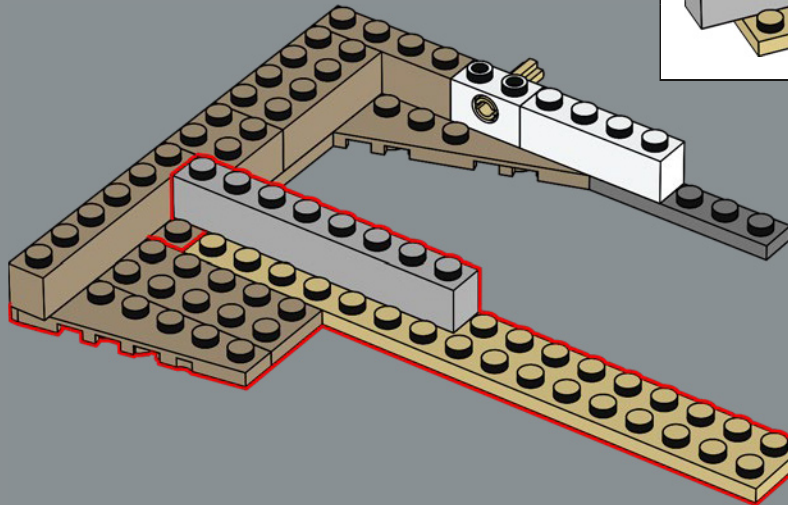
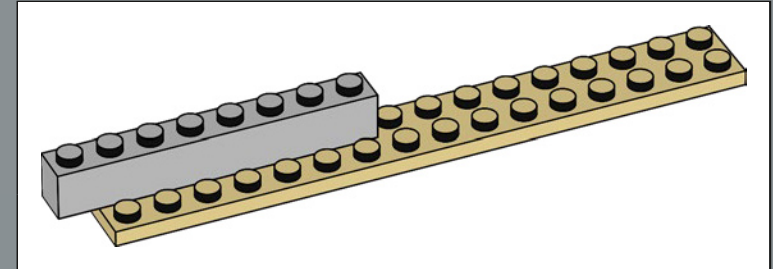

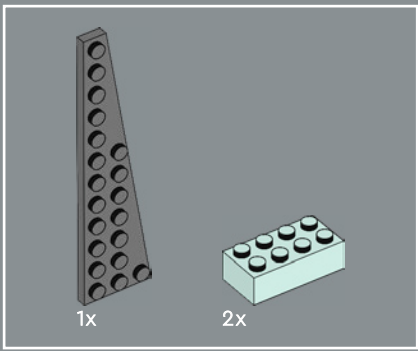

116

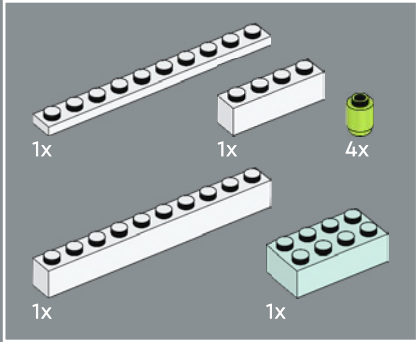
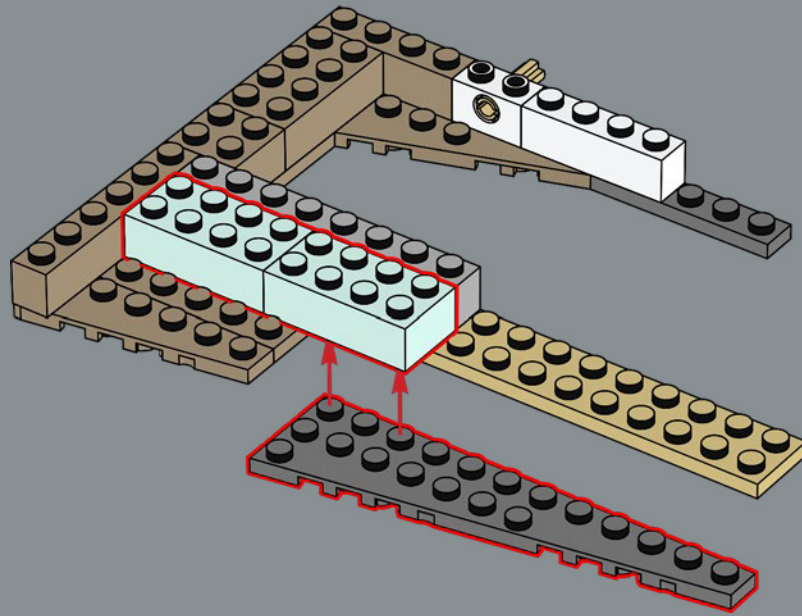

117

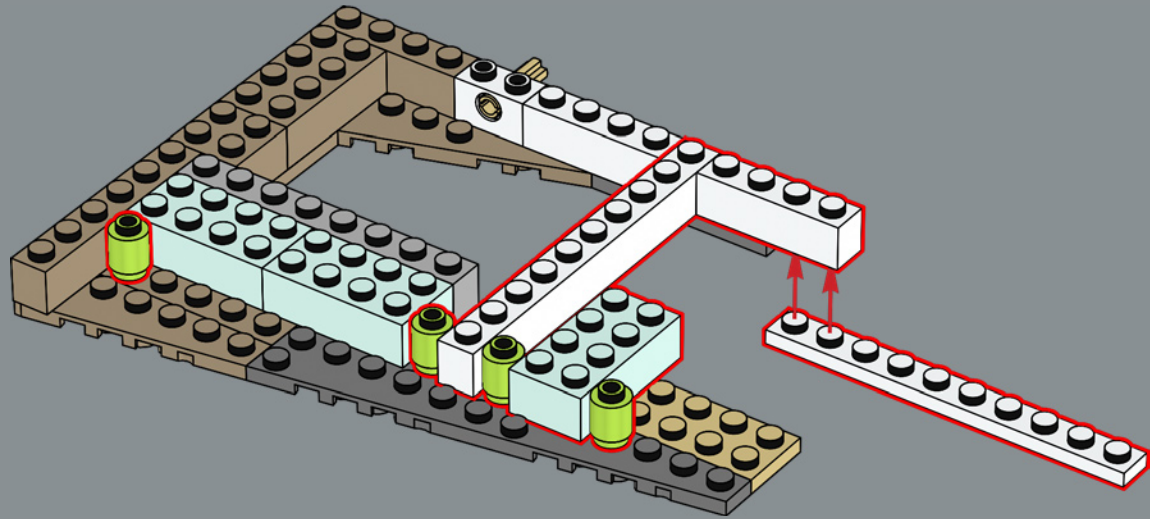

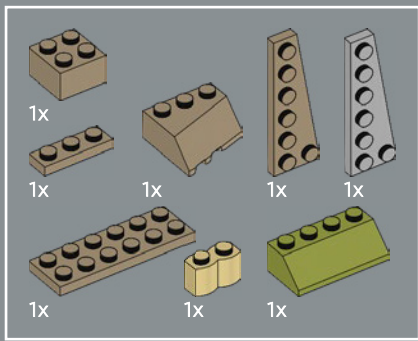

118

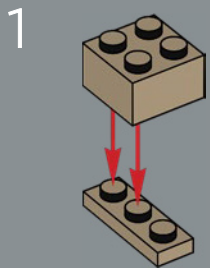

2

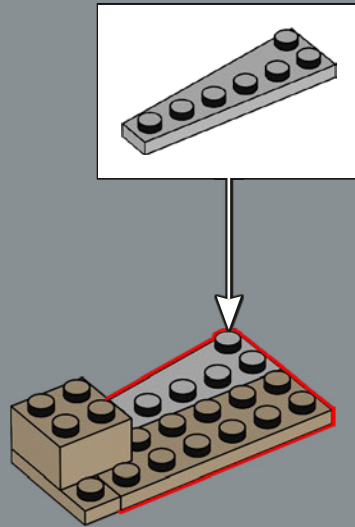

3

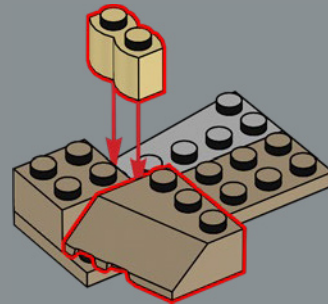

4

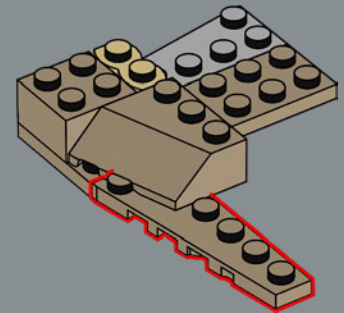

5

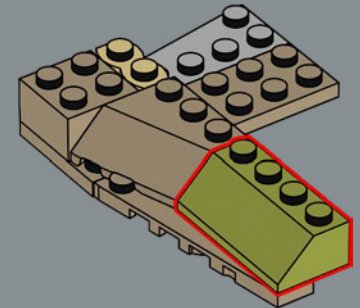

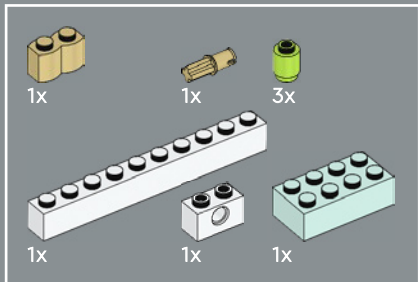
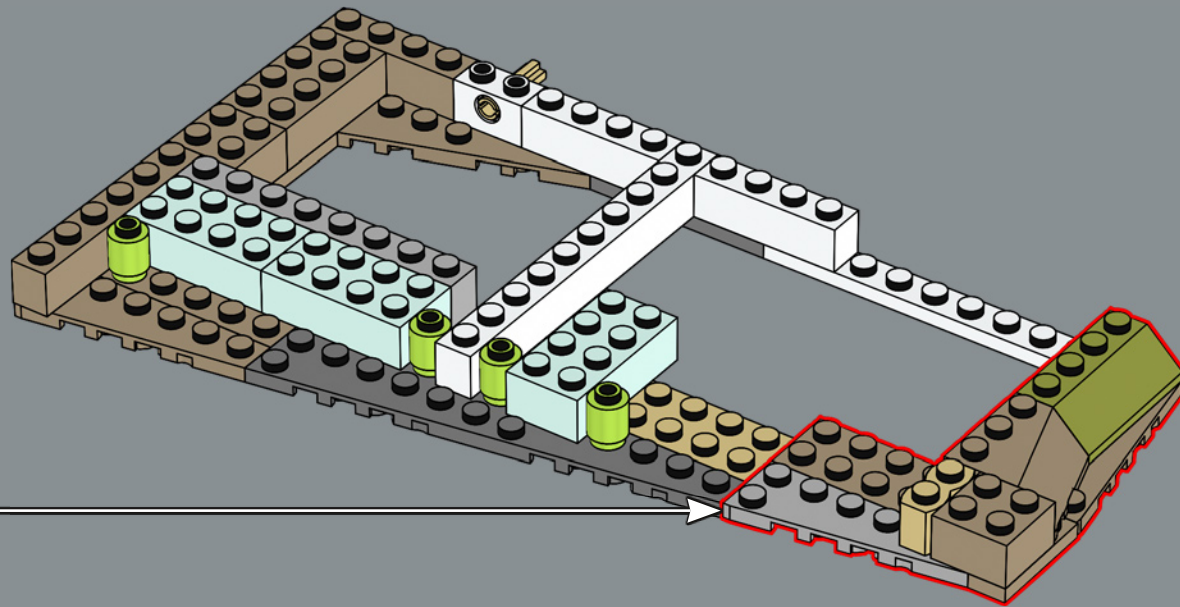

119

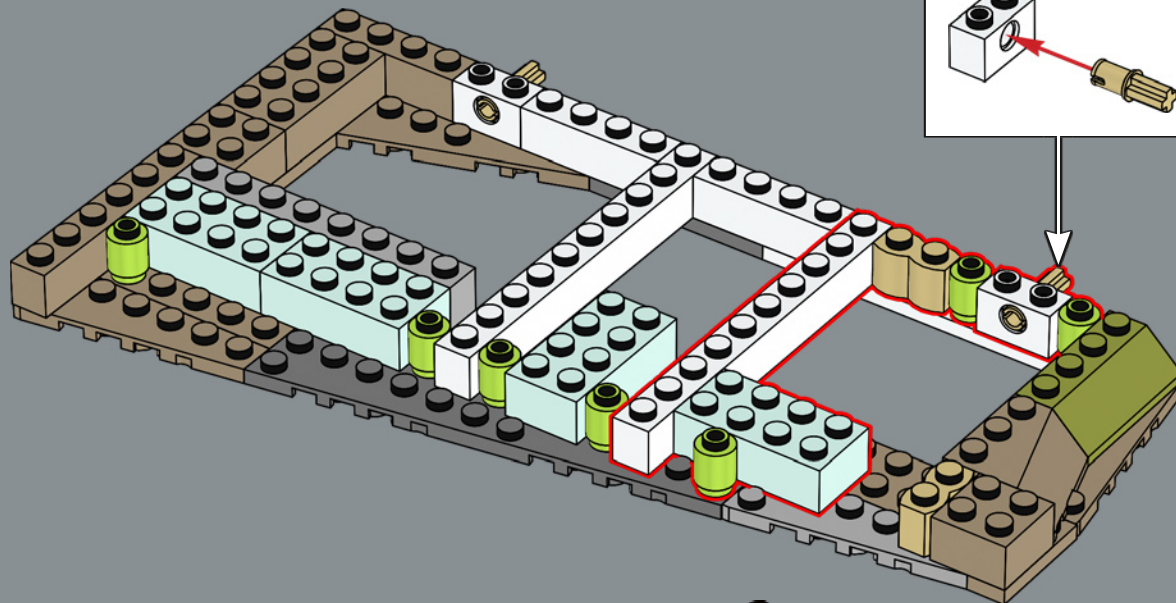
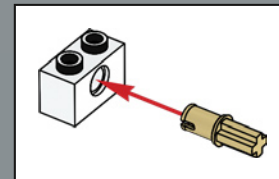



120

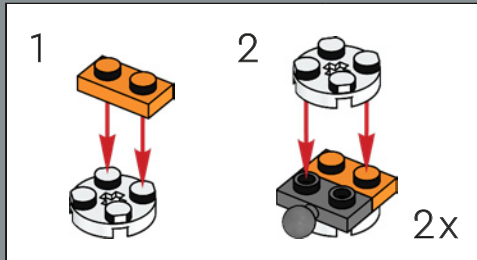
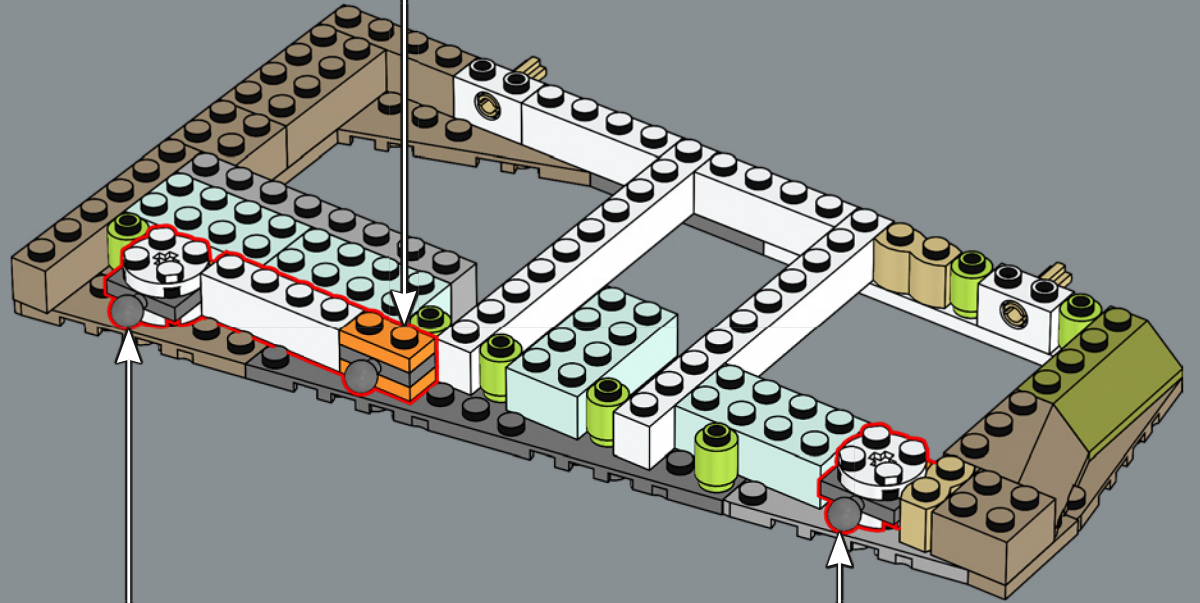
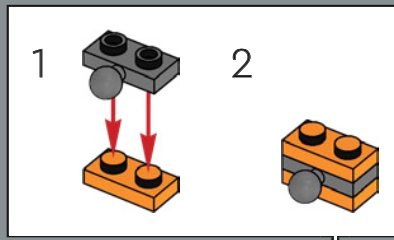

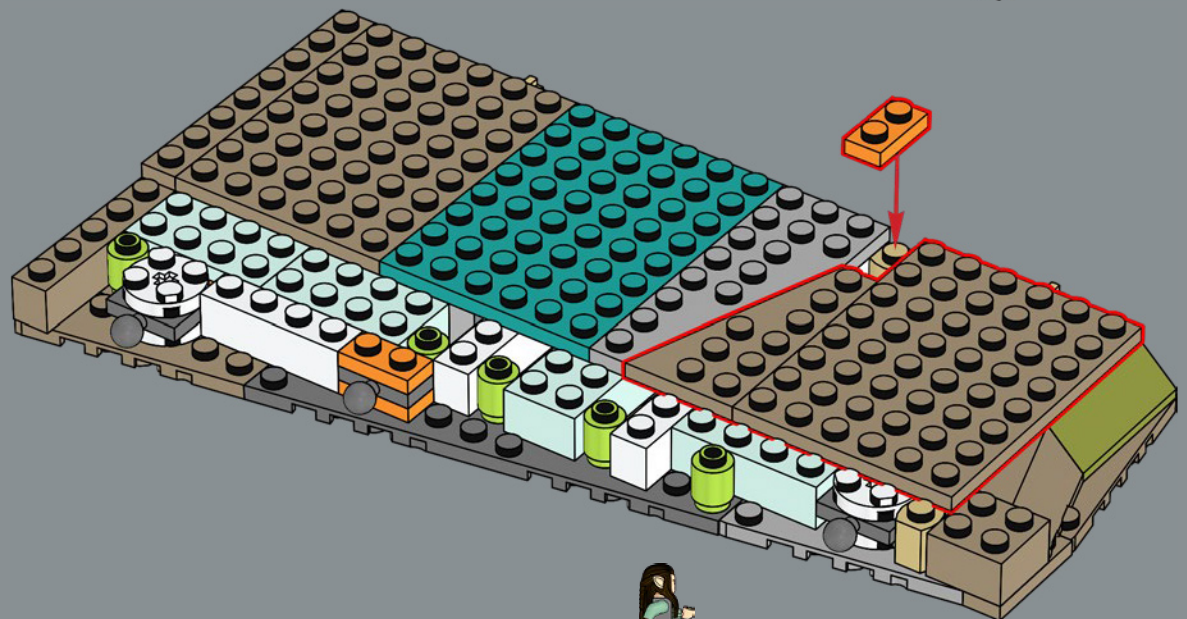
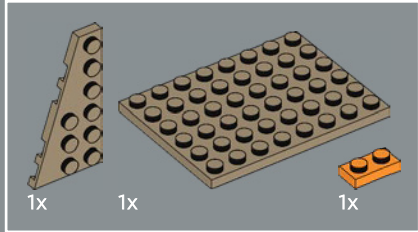
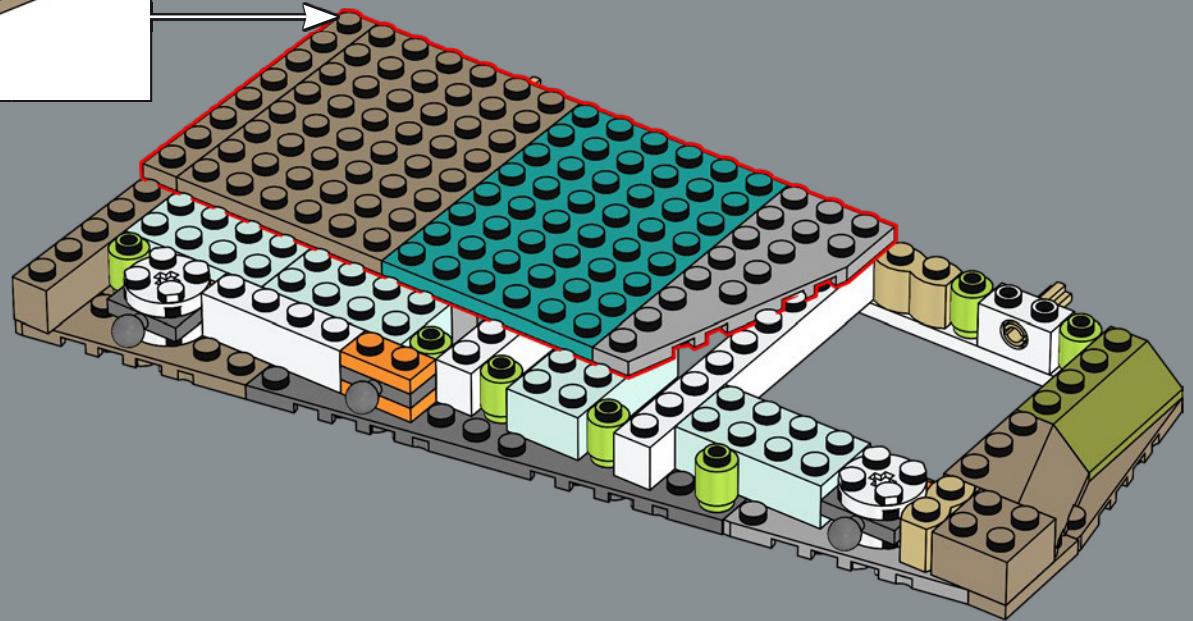
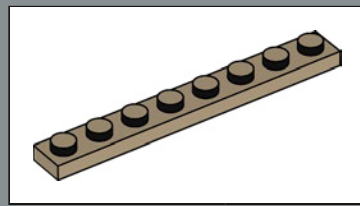
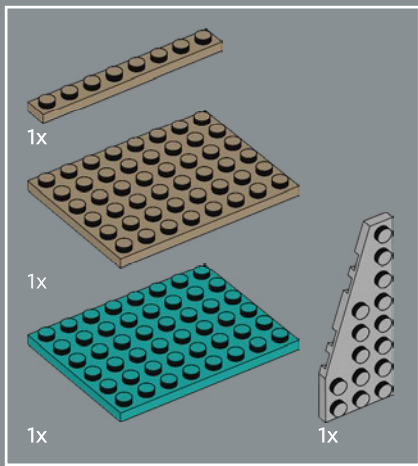

121

122



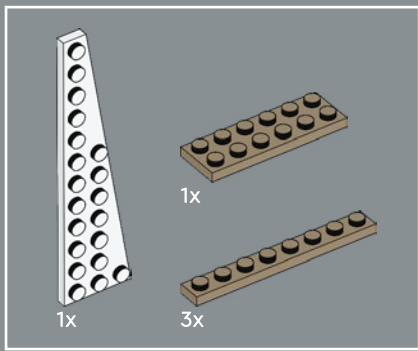

123

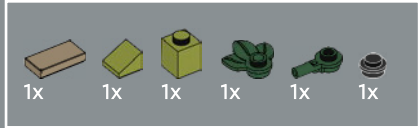
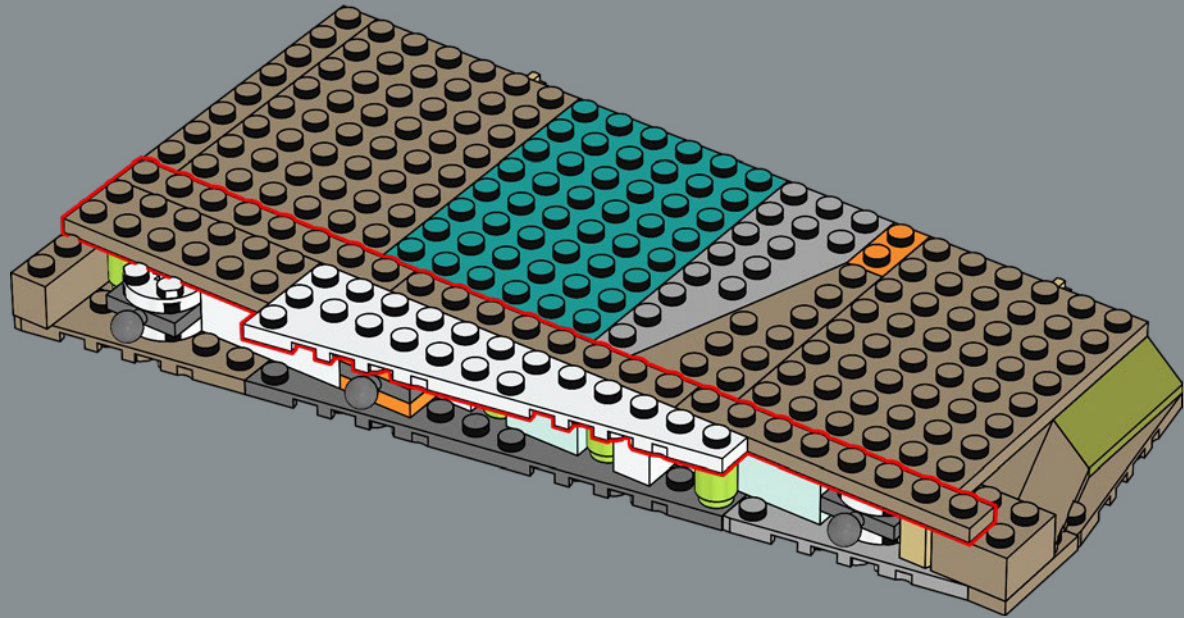

124

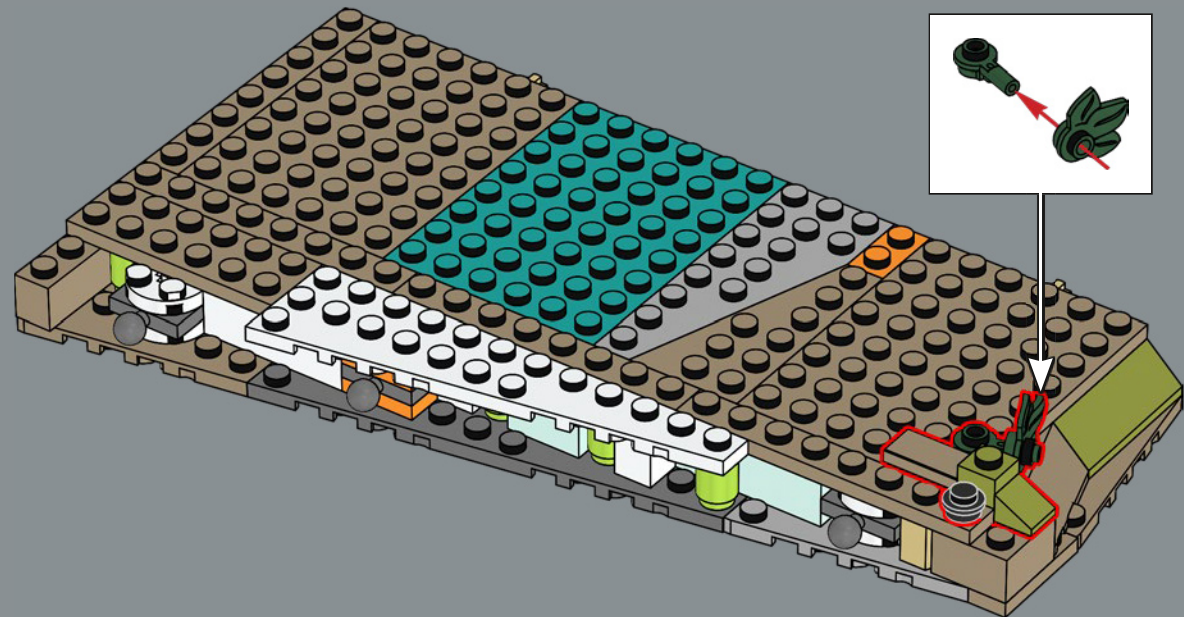

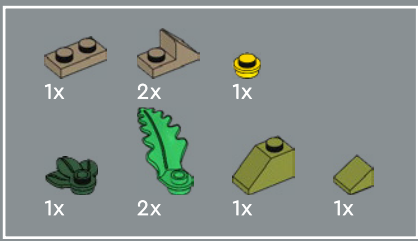

125



In diesem Segment ist alles vorhanden: Dreiecke, blaugüne Elemente, Farne und farblich aufeinander abgestimmte Keilplatten!

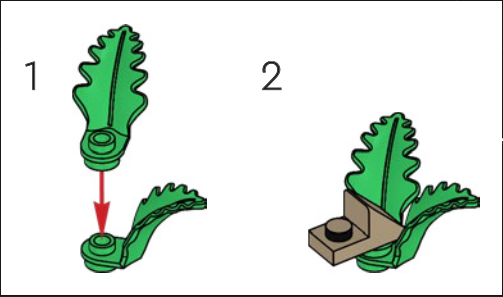
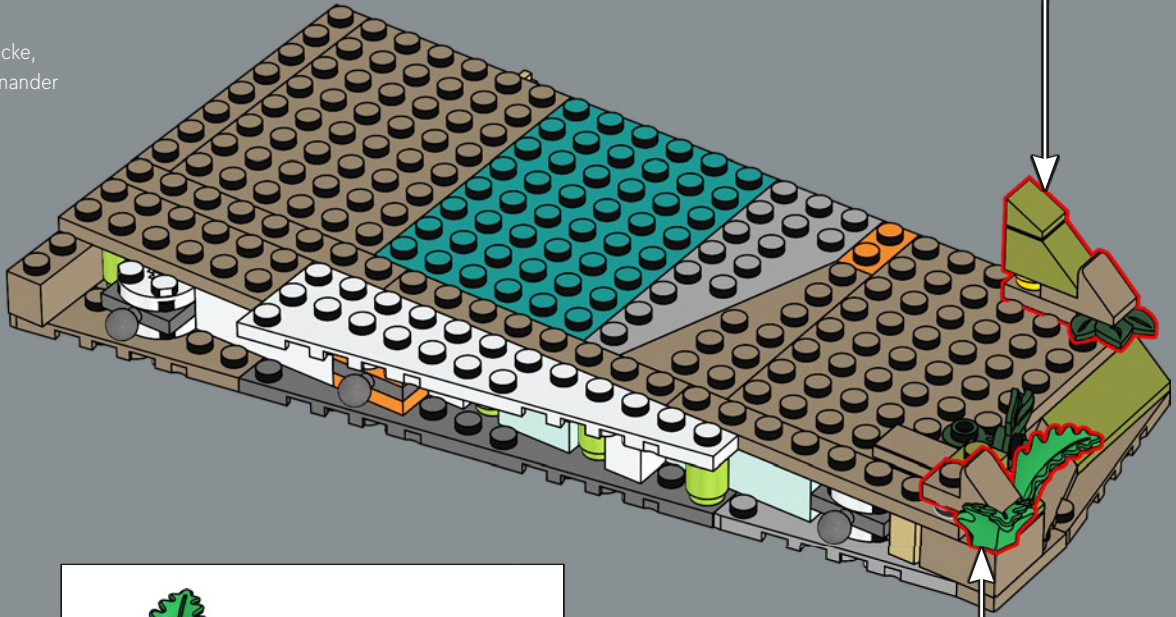
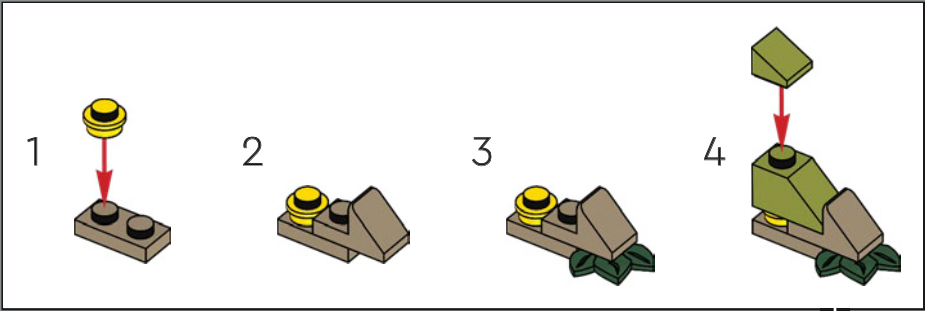

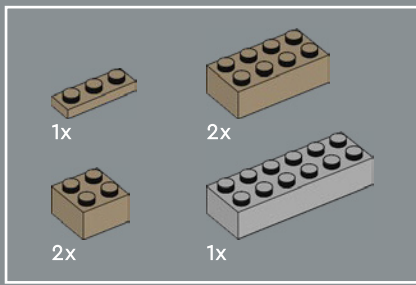

126

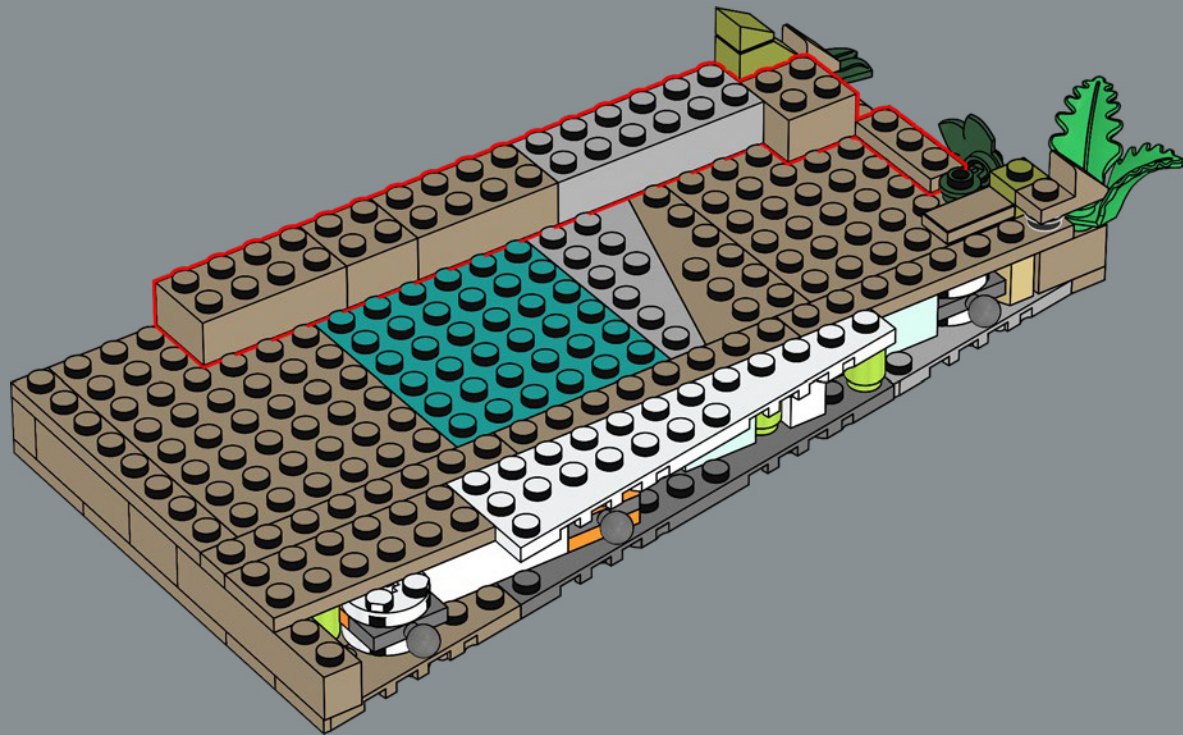

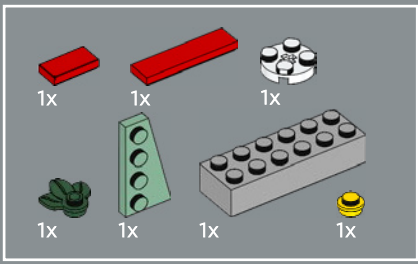

127

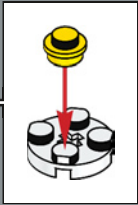
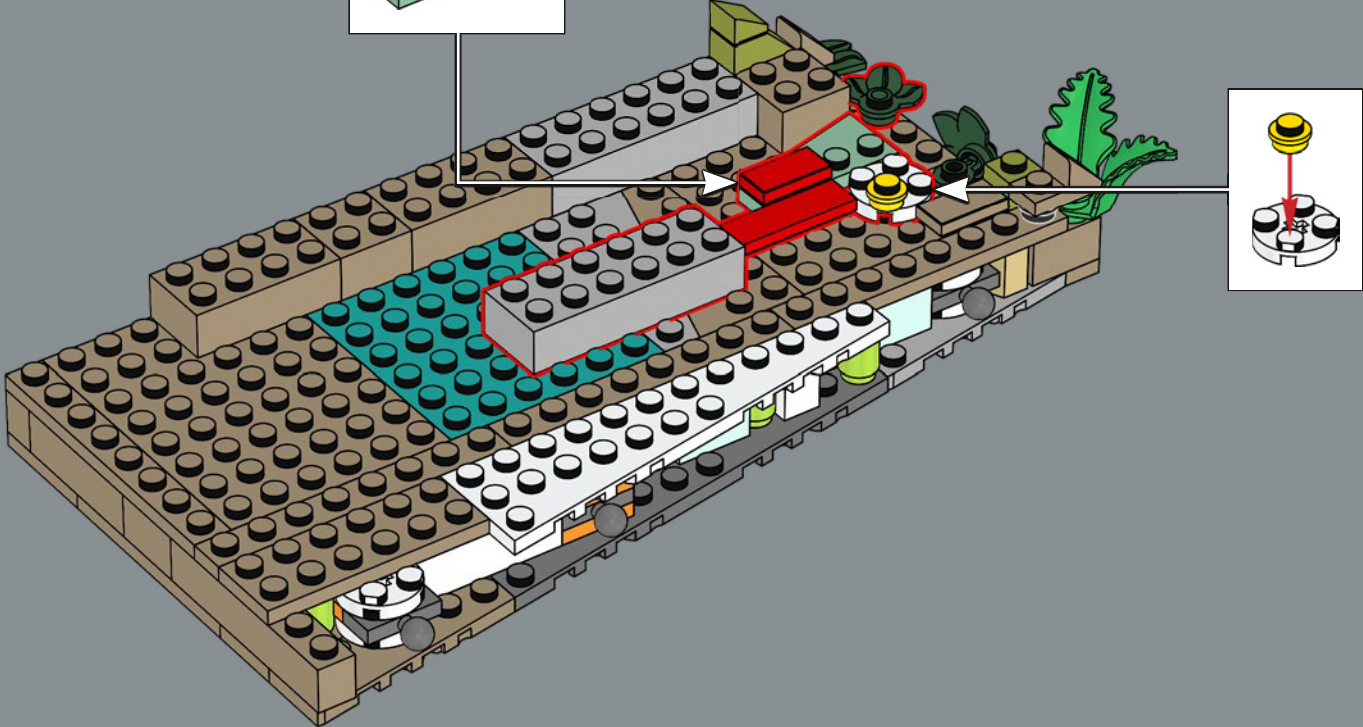
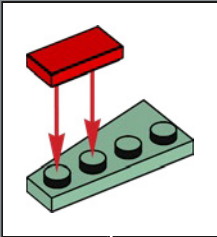

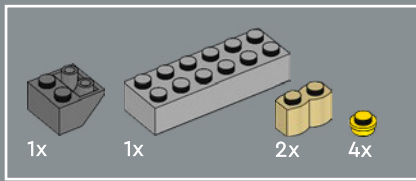

128

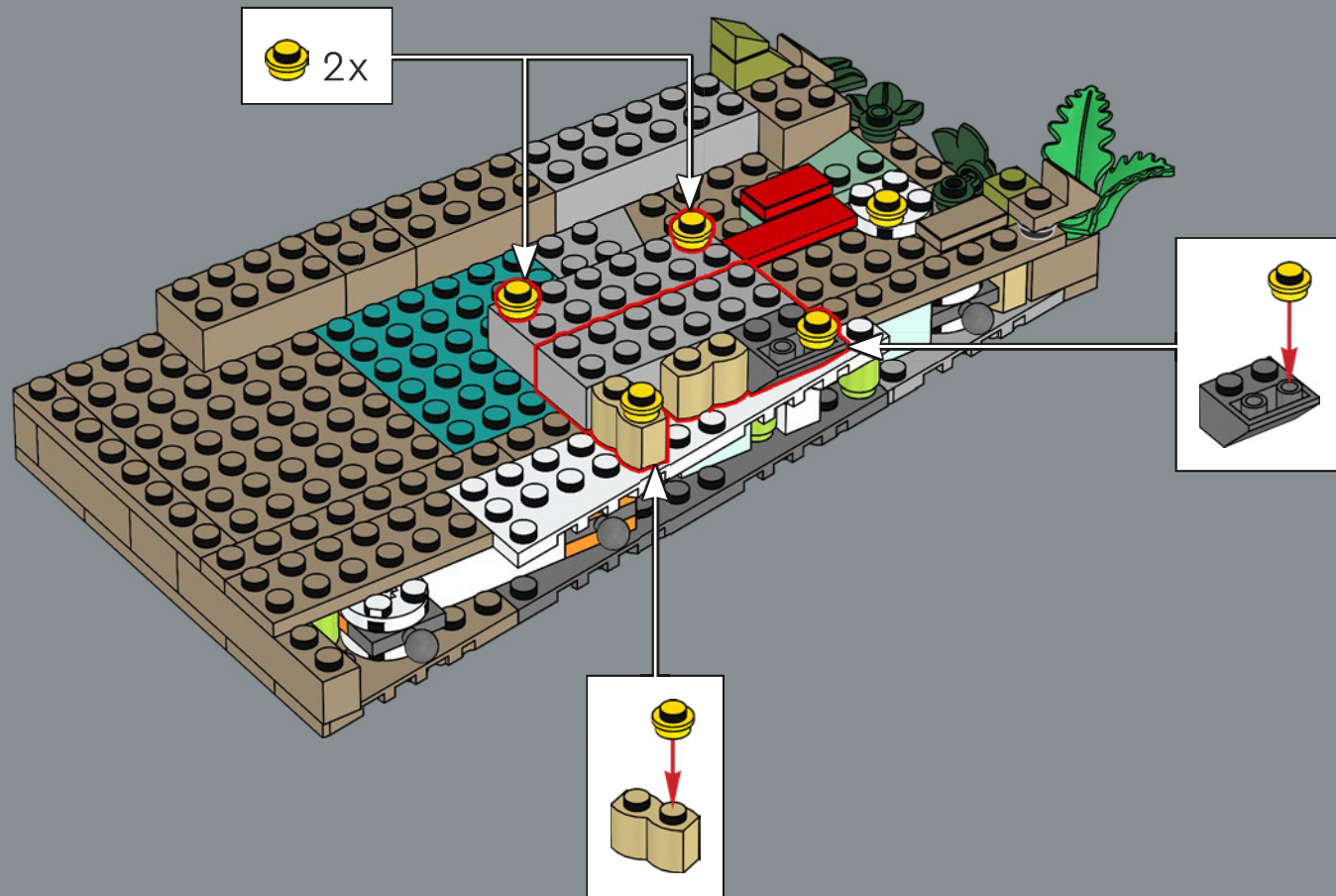

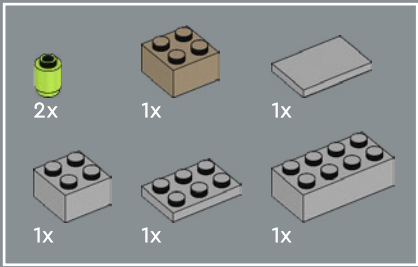

129

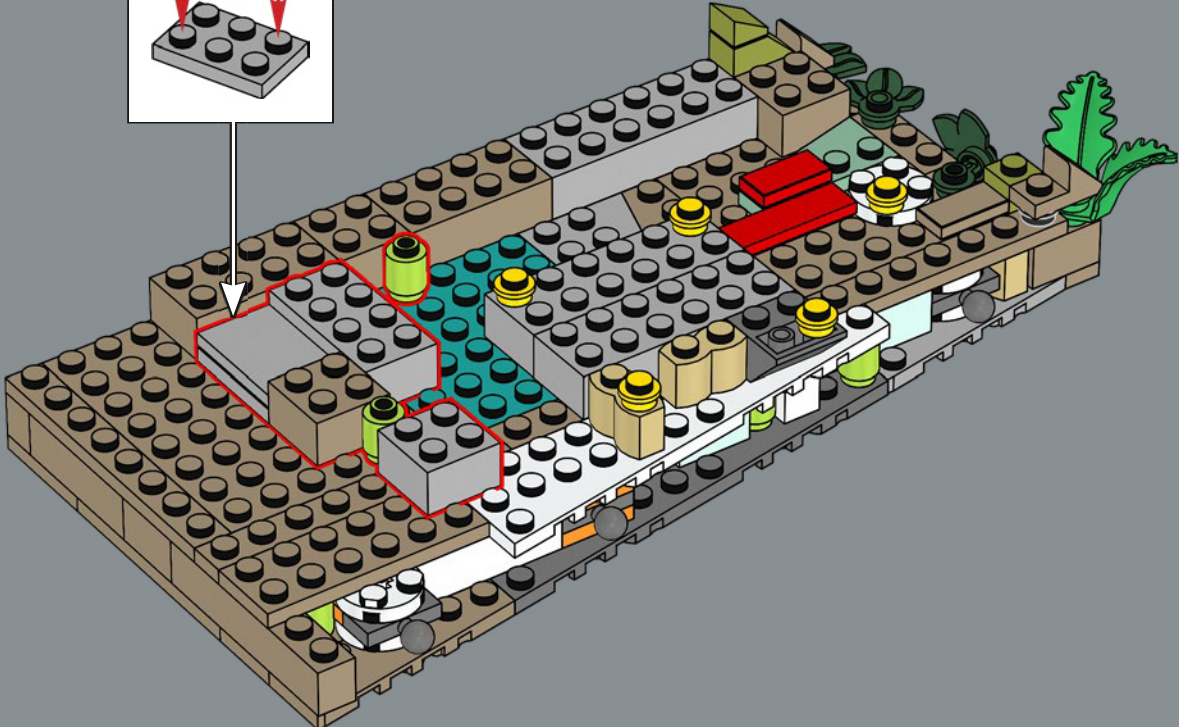
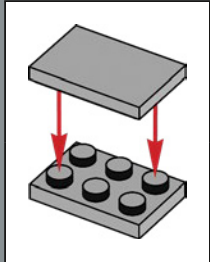

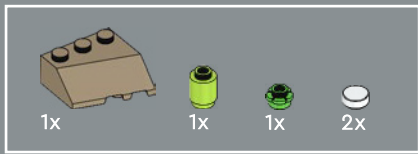

130

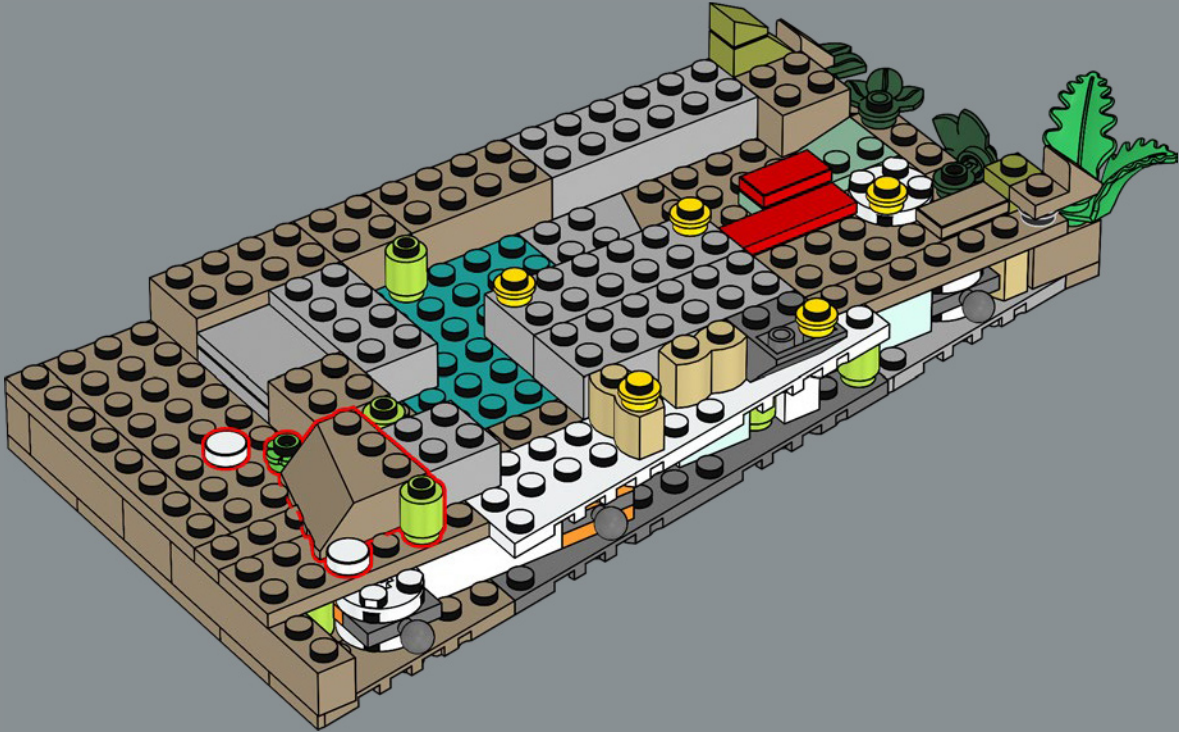

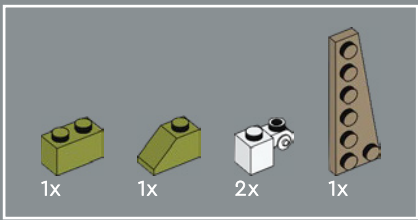

131

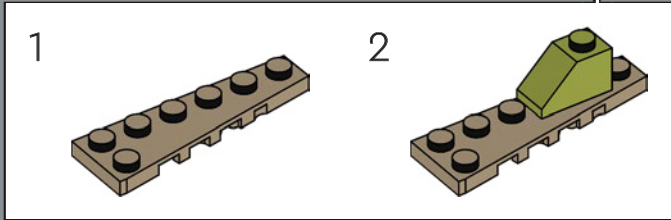
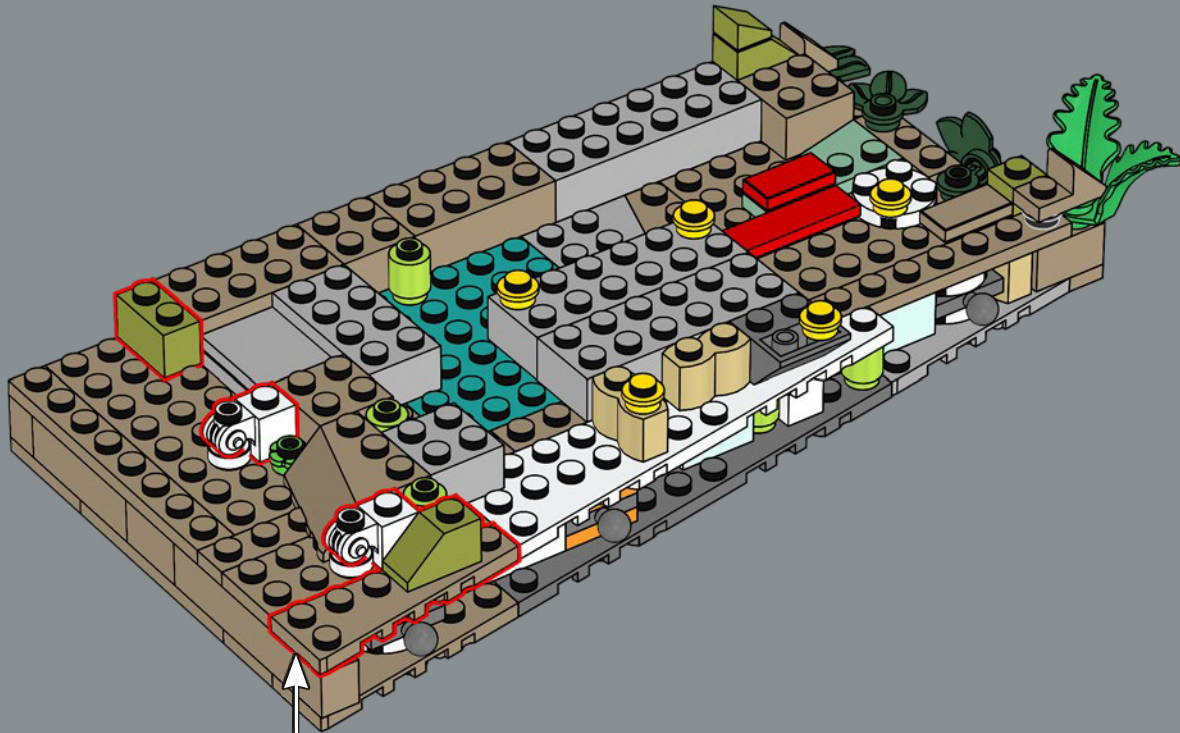

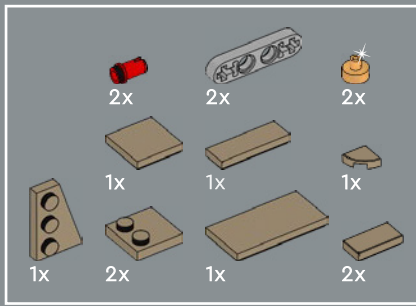

132

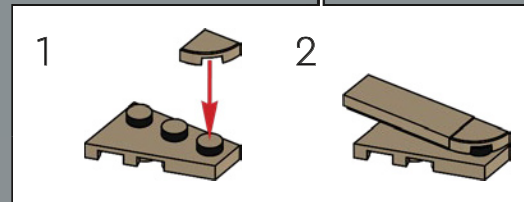
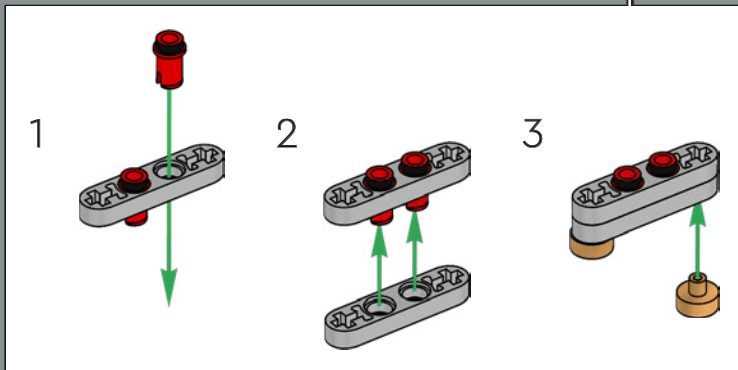
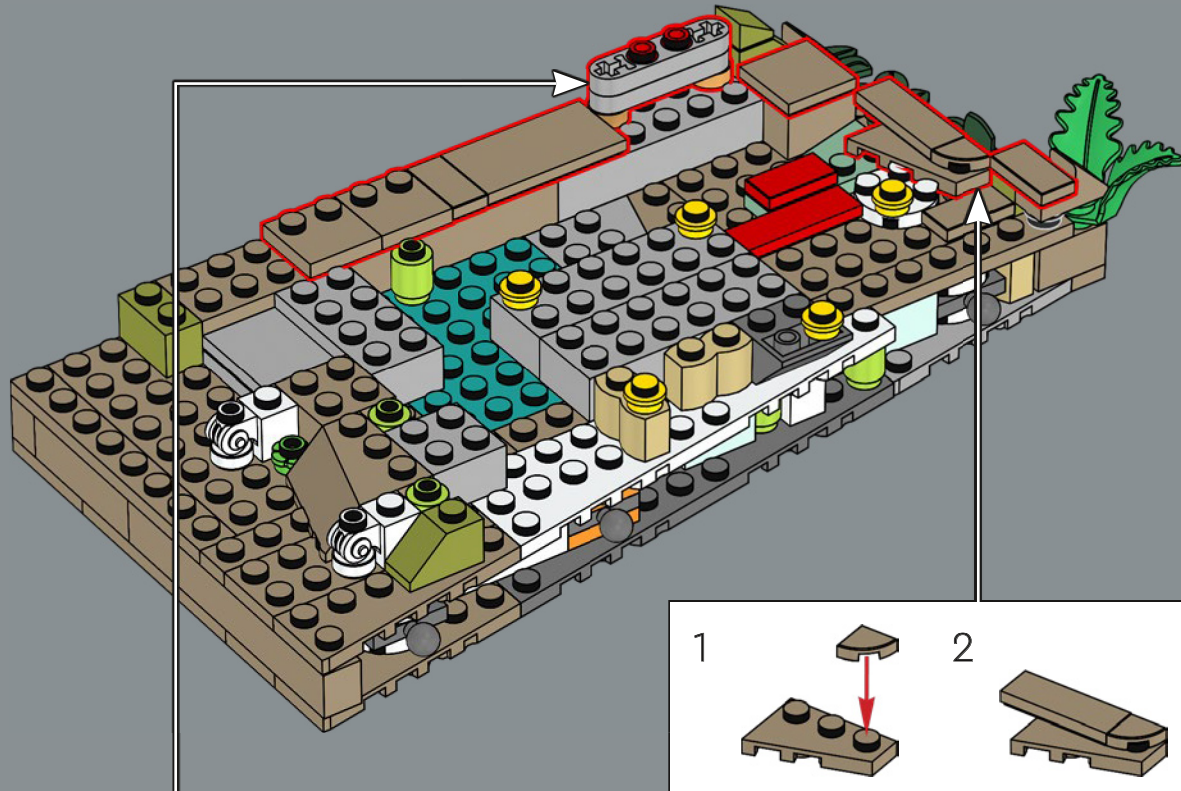

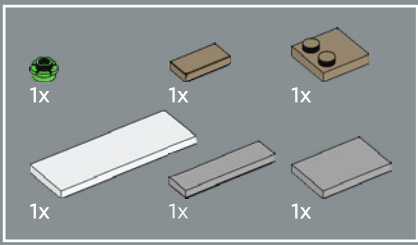

133

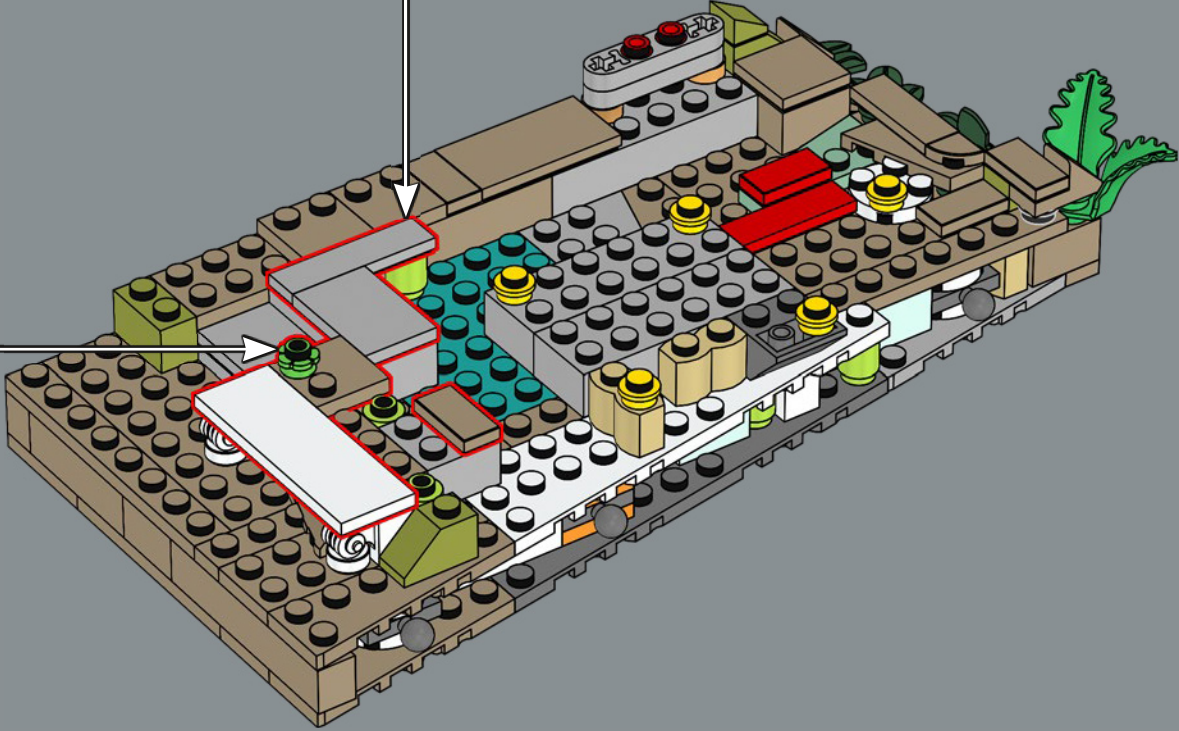
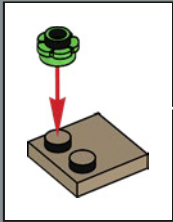
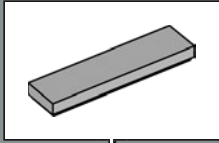

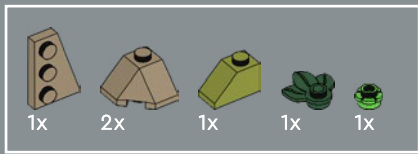

134

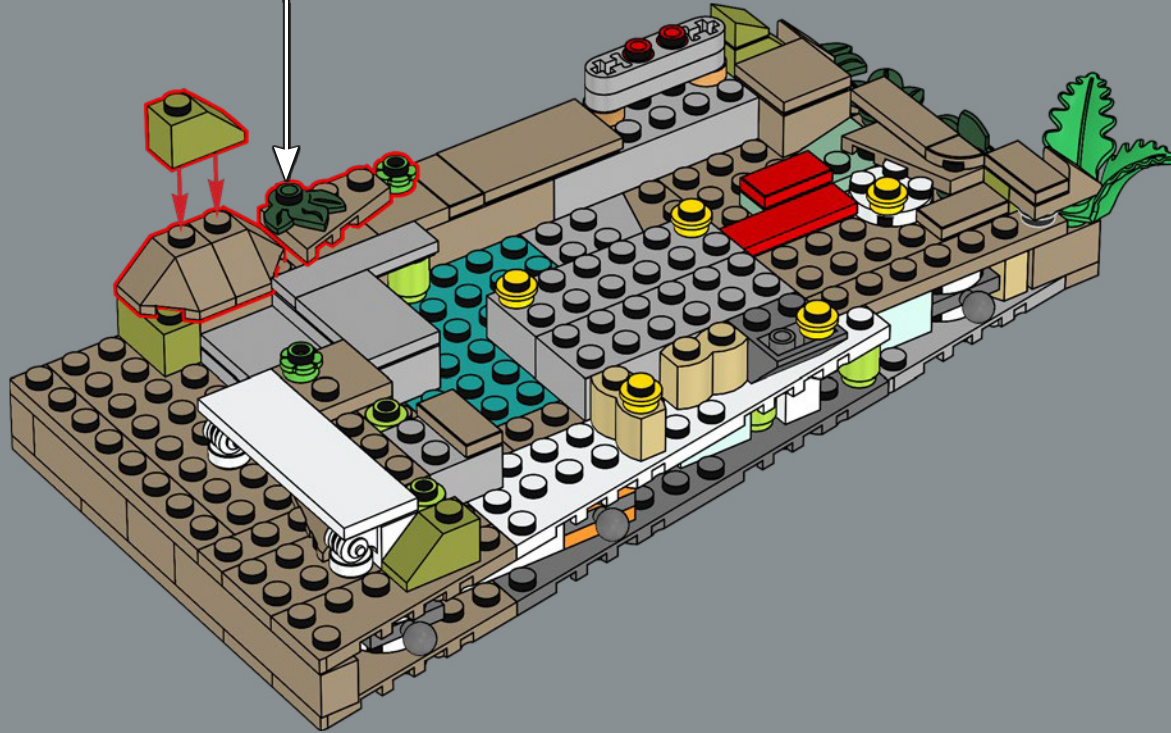
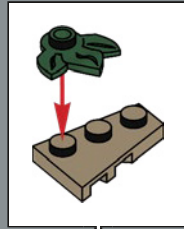



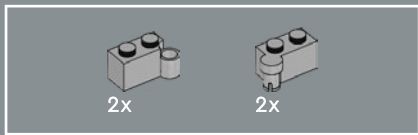

136

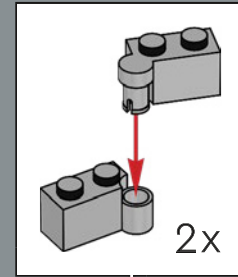

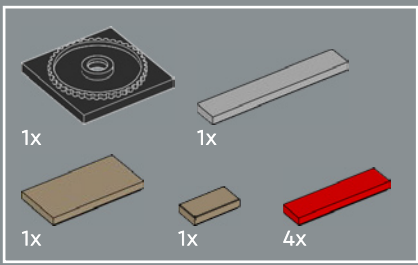

137



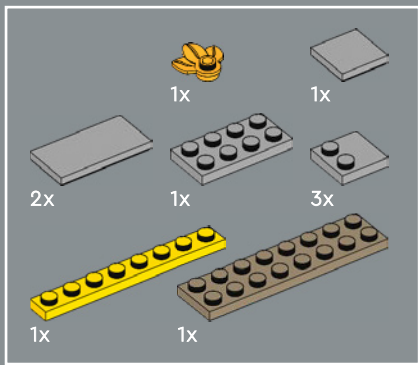

138

1

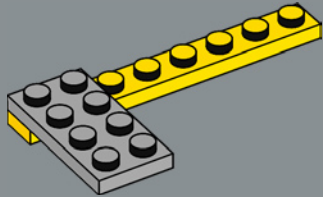

2

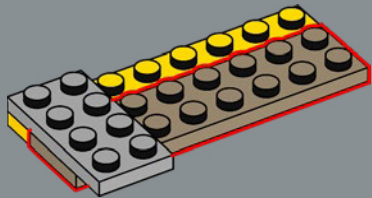

3

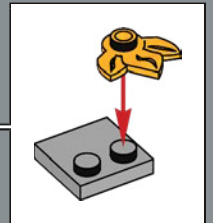
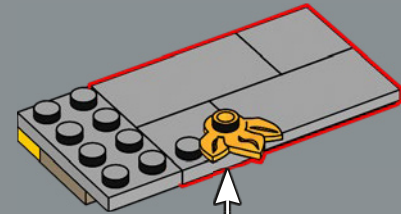

4

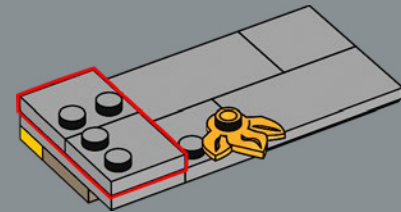



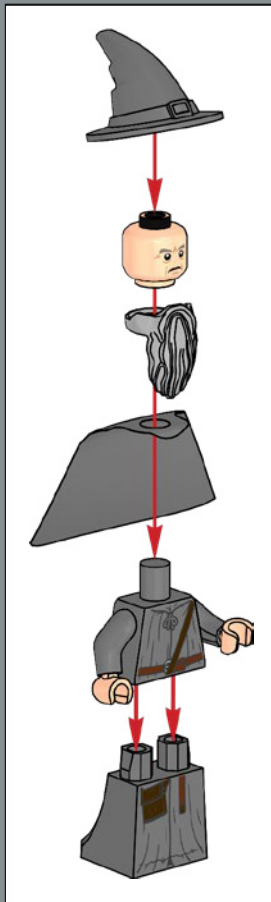
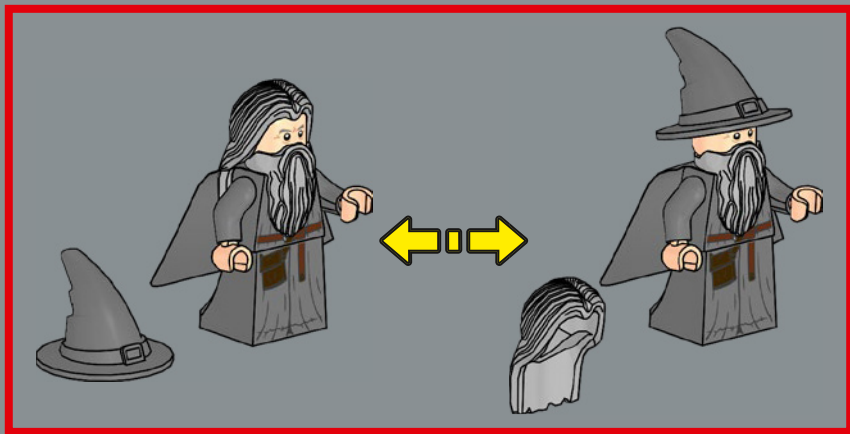
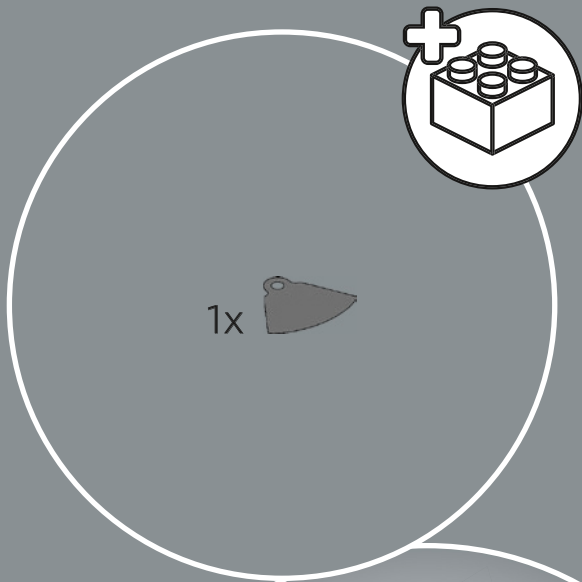

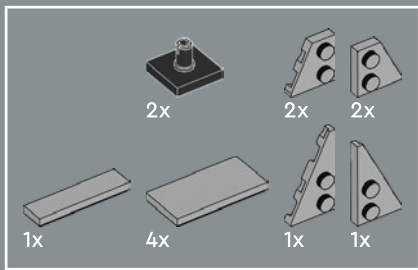

139



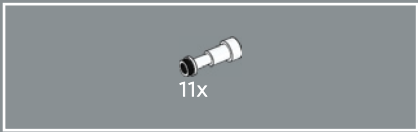

140



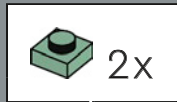
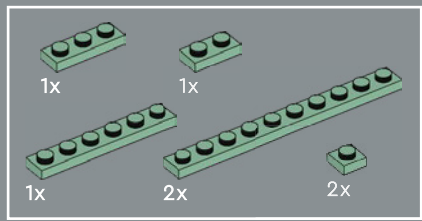

141

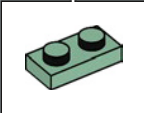



Dieses Zierelement an der elbischen Säule diente in anderen Sets bereits als Cupcake.

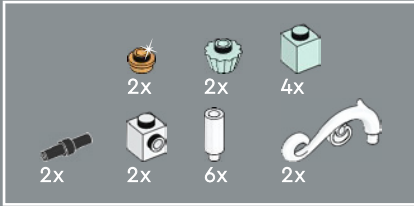
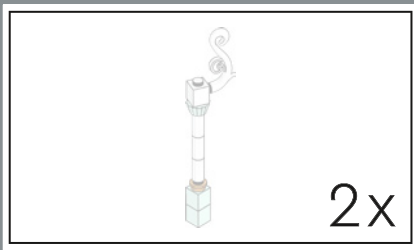

142

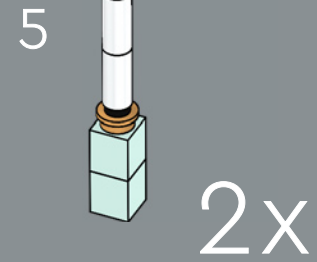
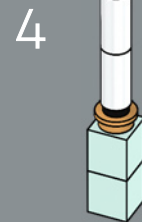
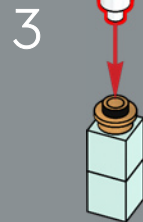
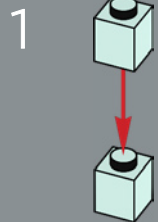

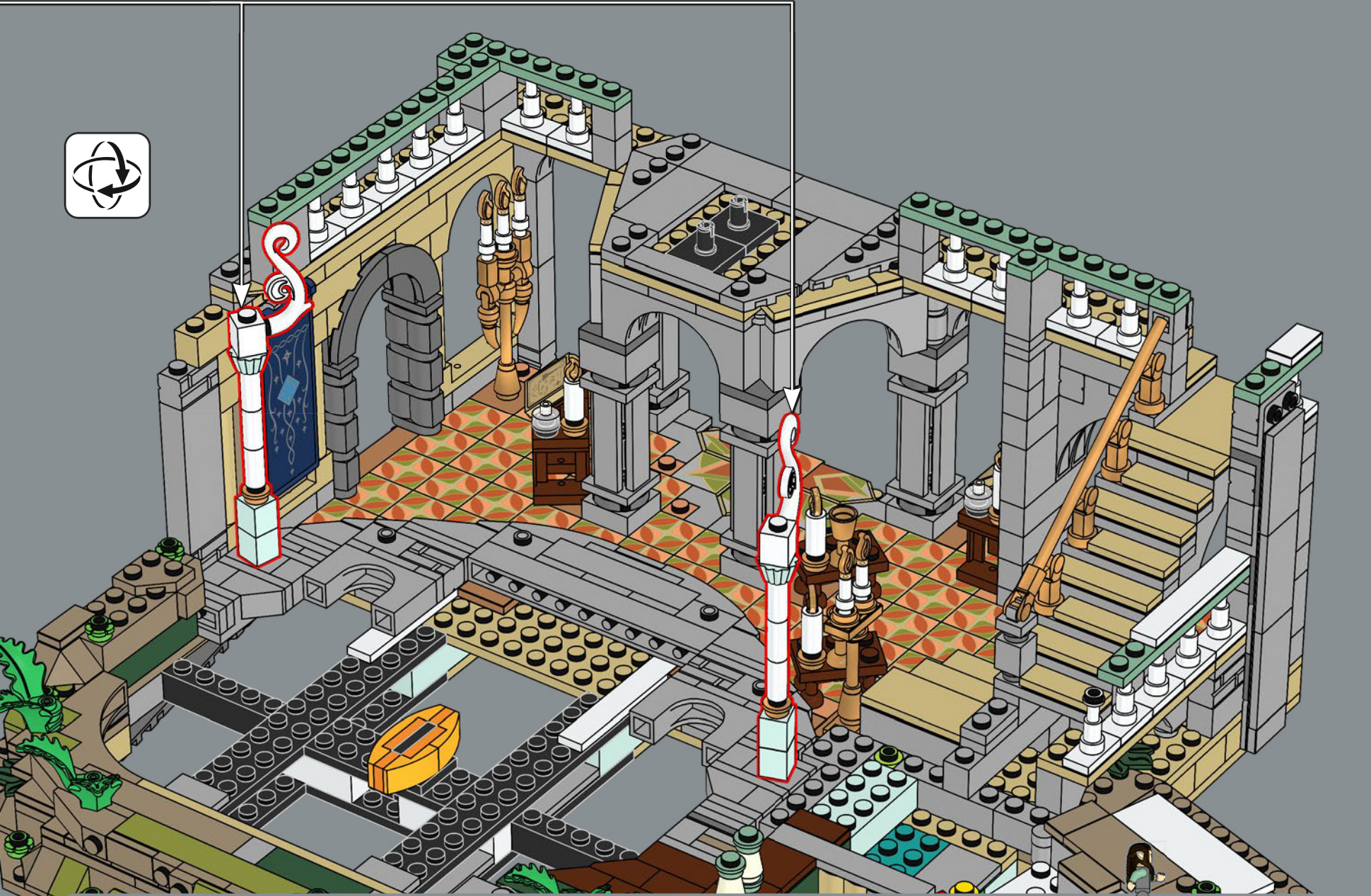

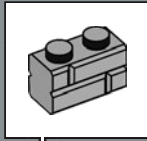
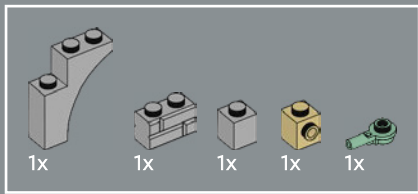

143

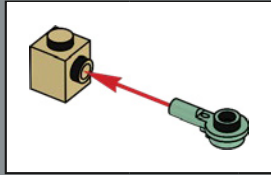

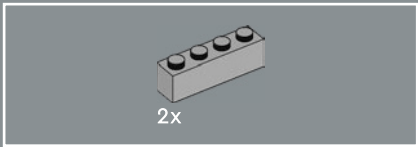

144



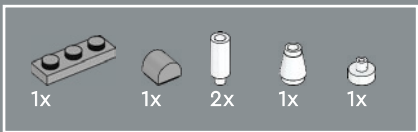

145

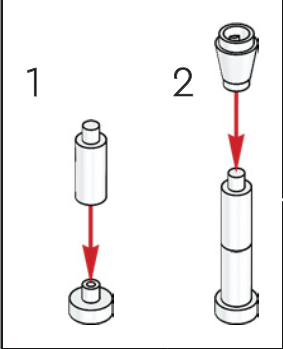
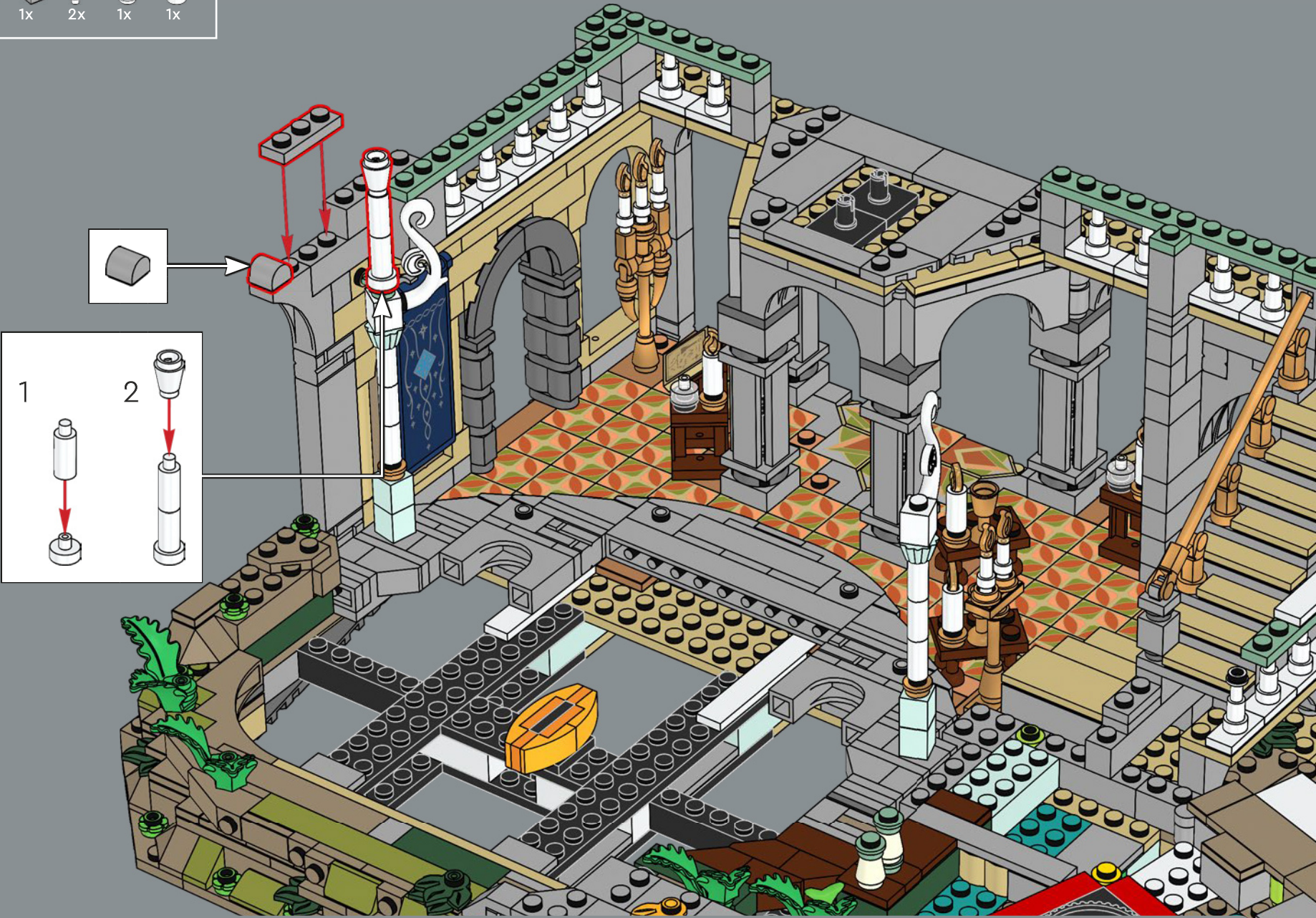

146

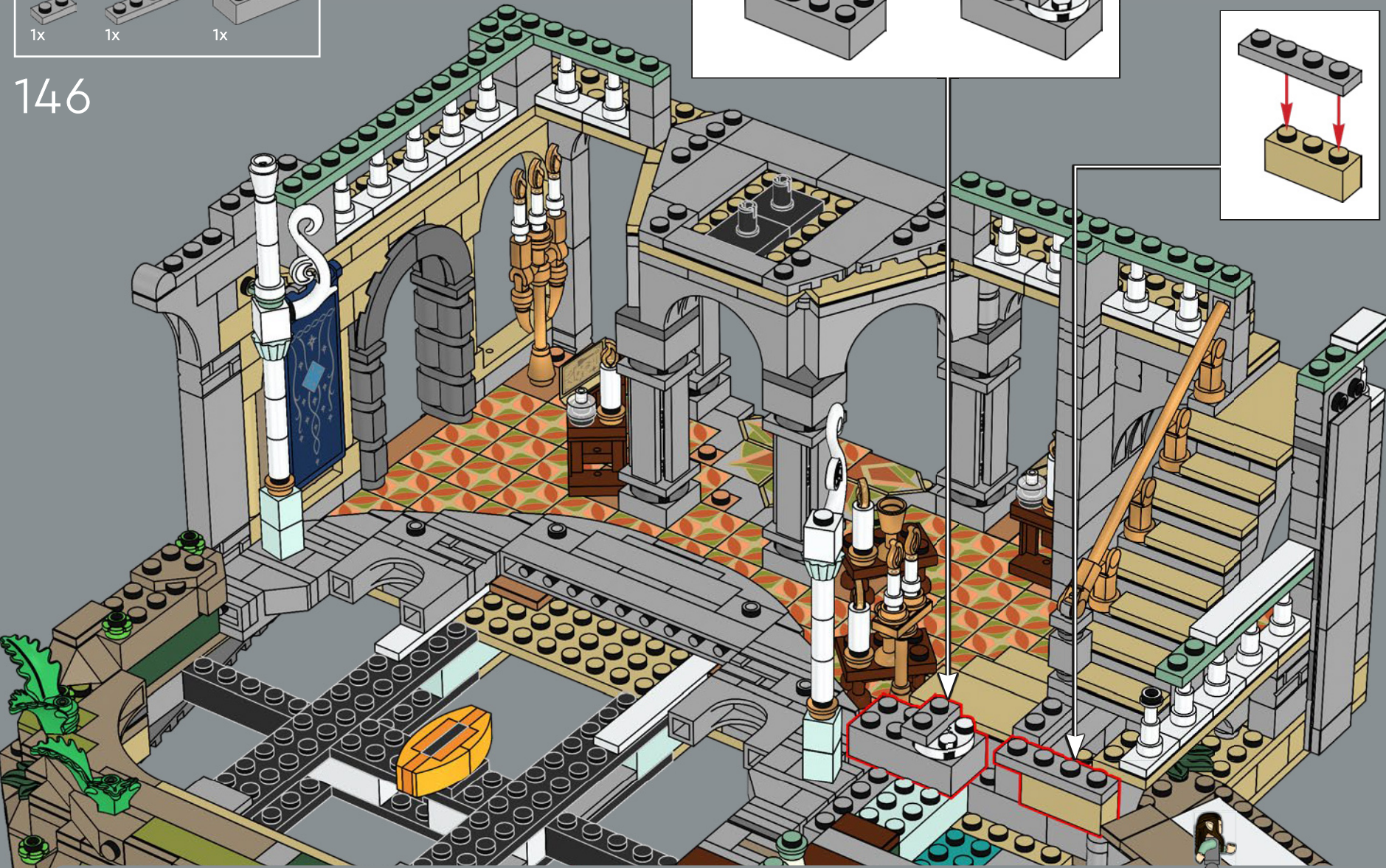
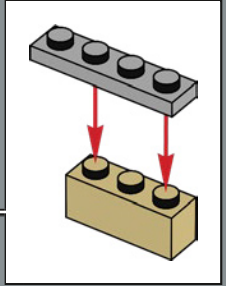
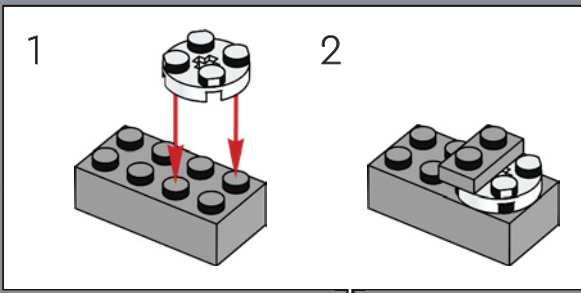
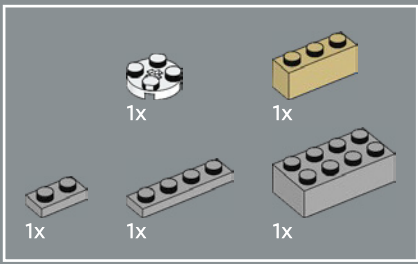

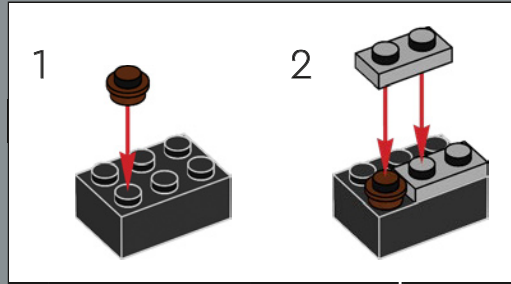
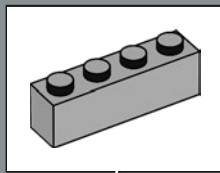
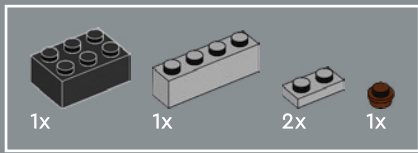

147

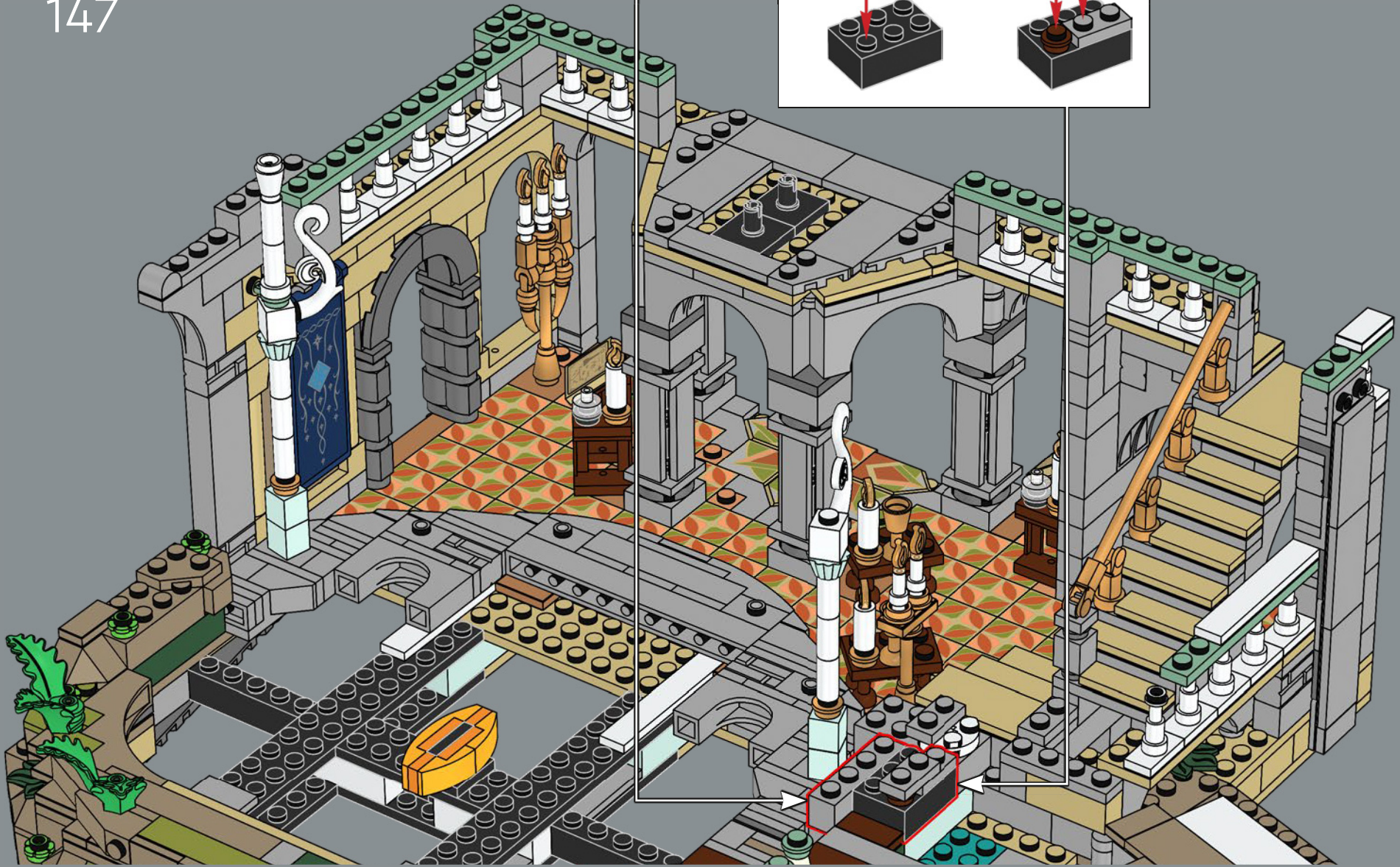

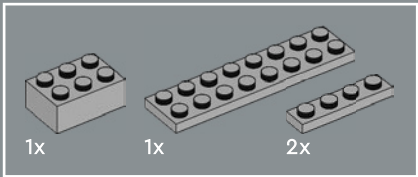

148

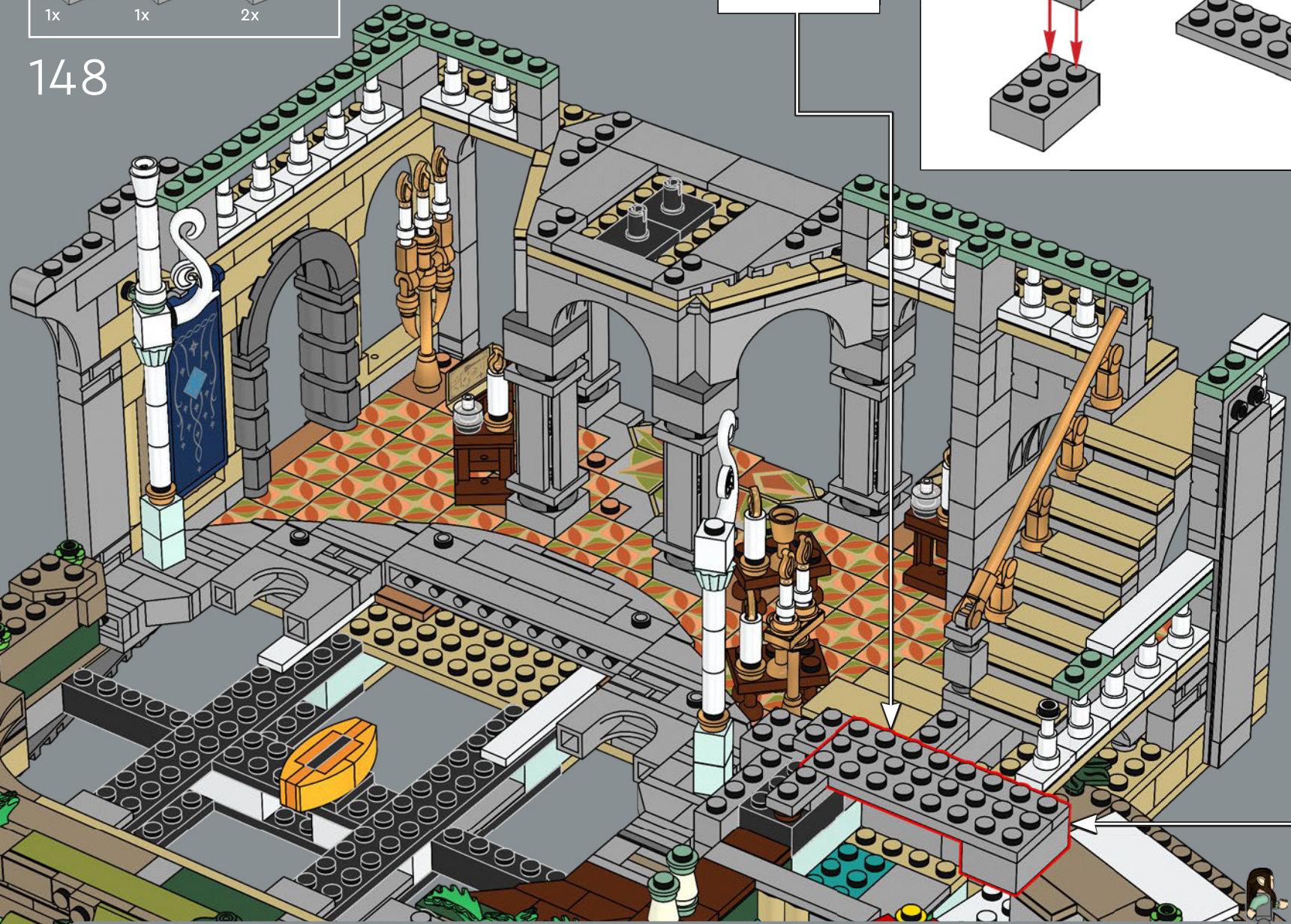
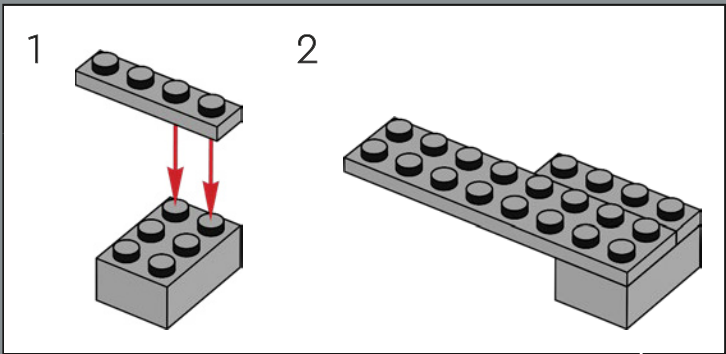
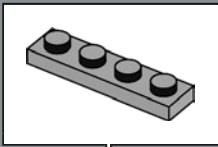

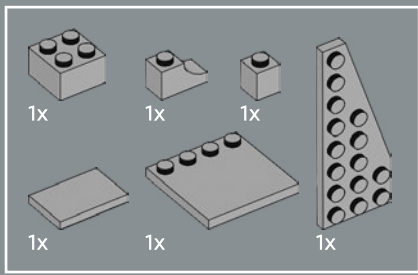

149



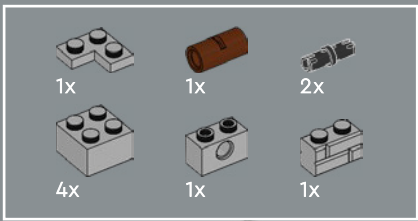

150

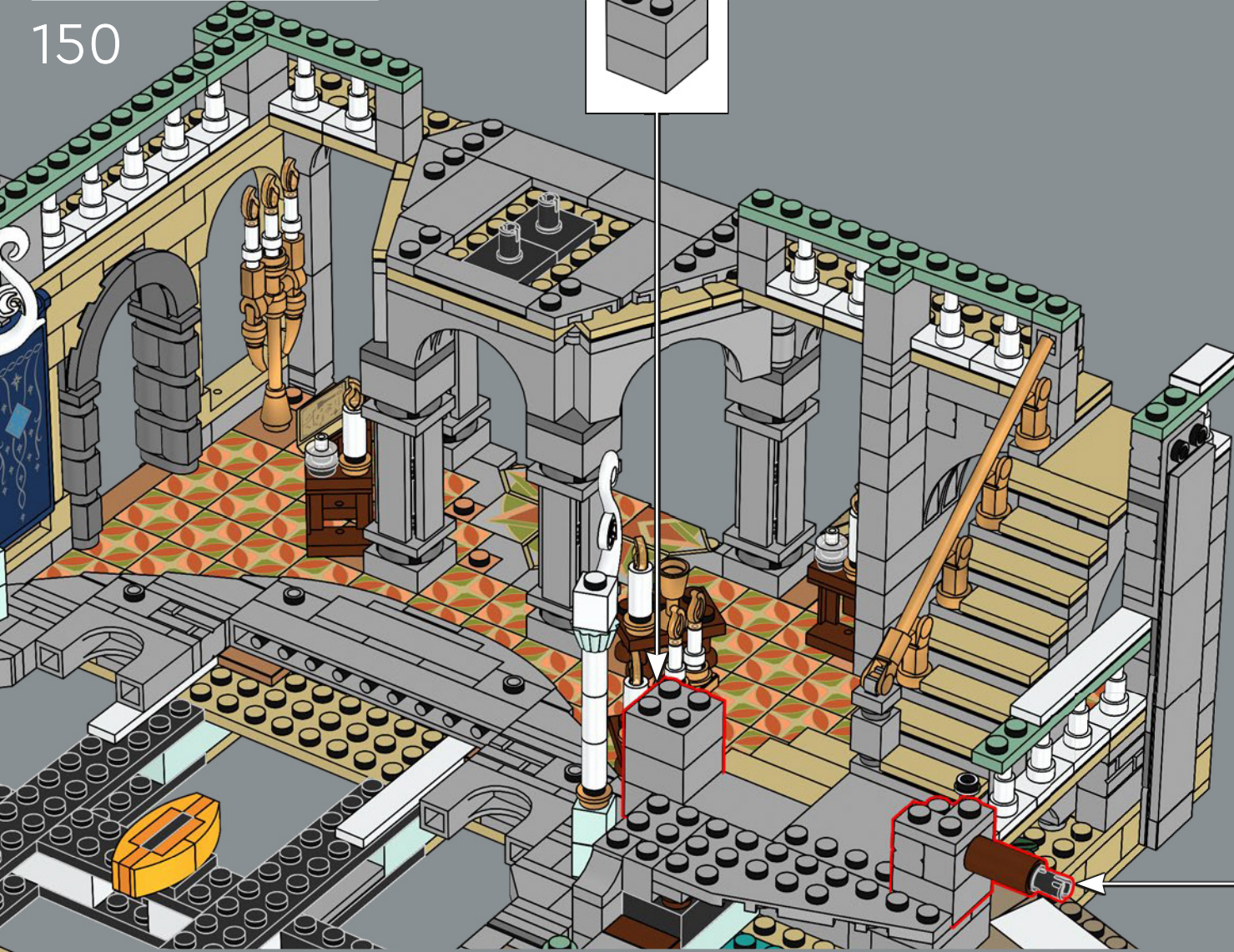
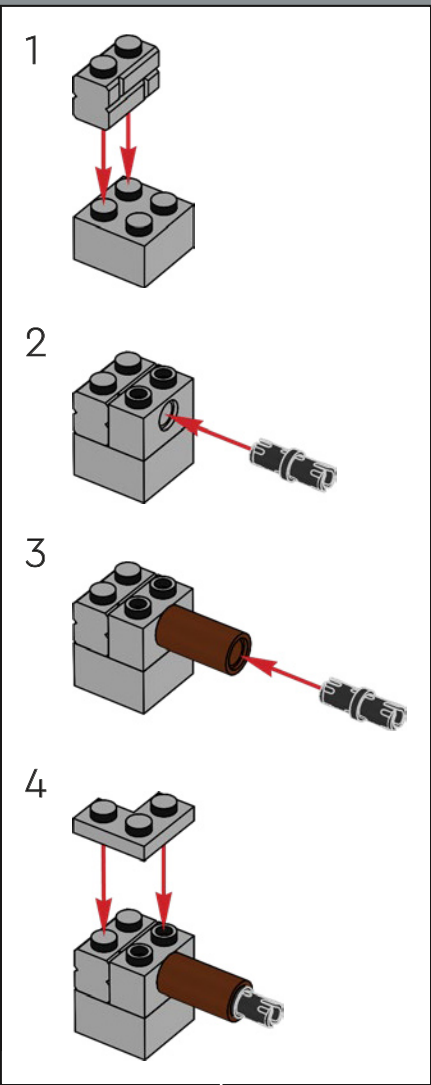
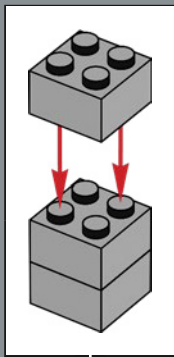

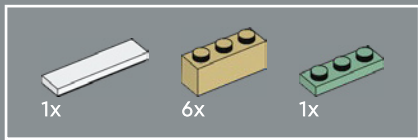

151

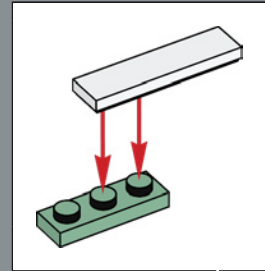
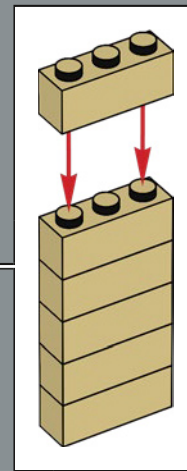



14x

152

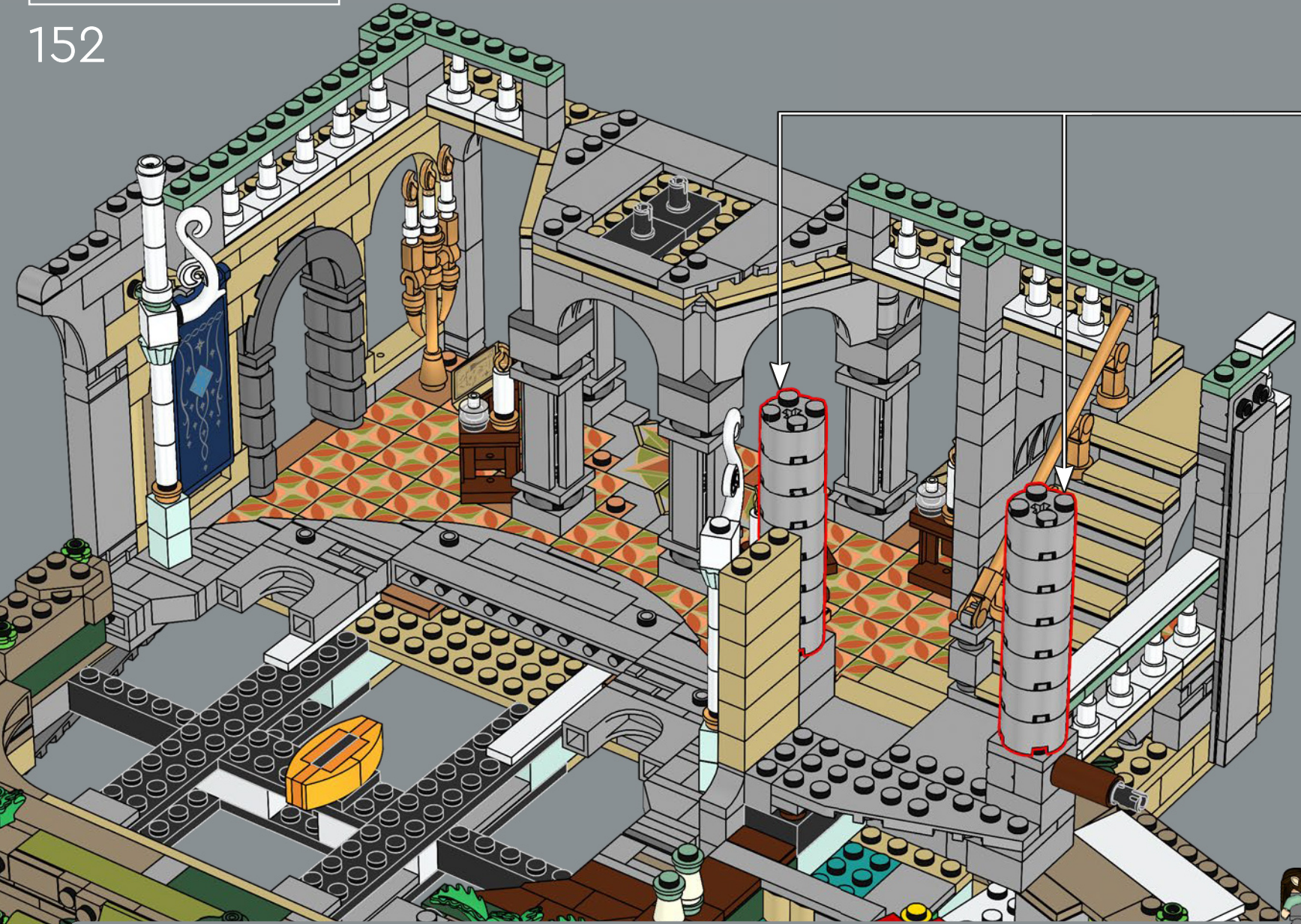

2x



2x

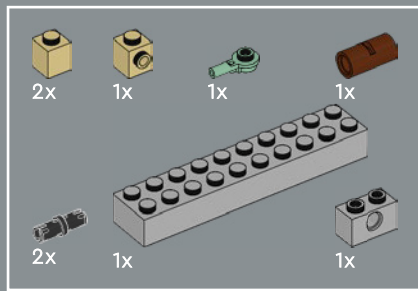

153

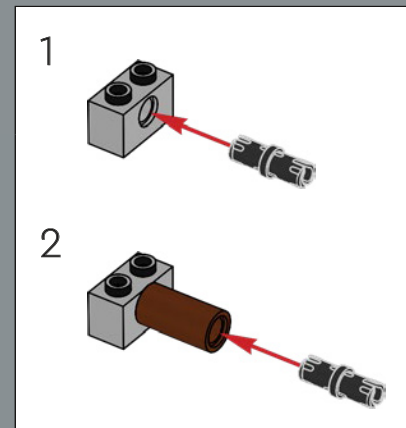
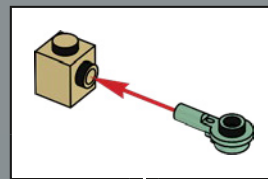

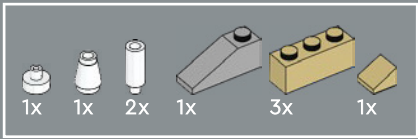

154

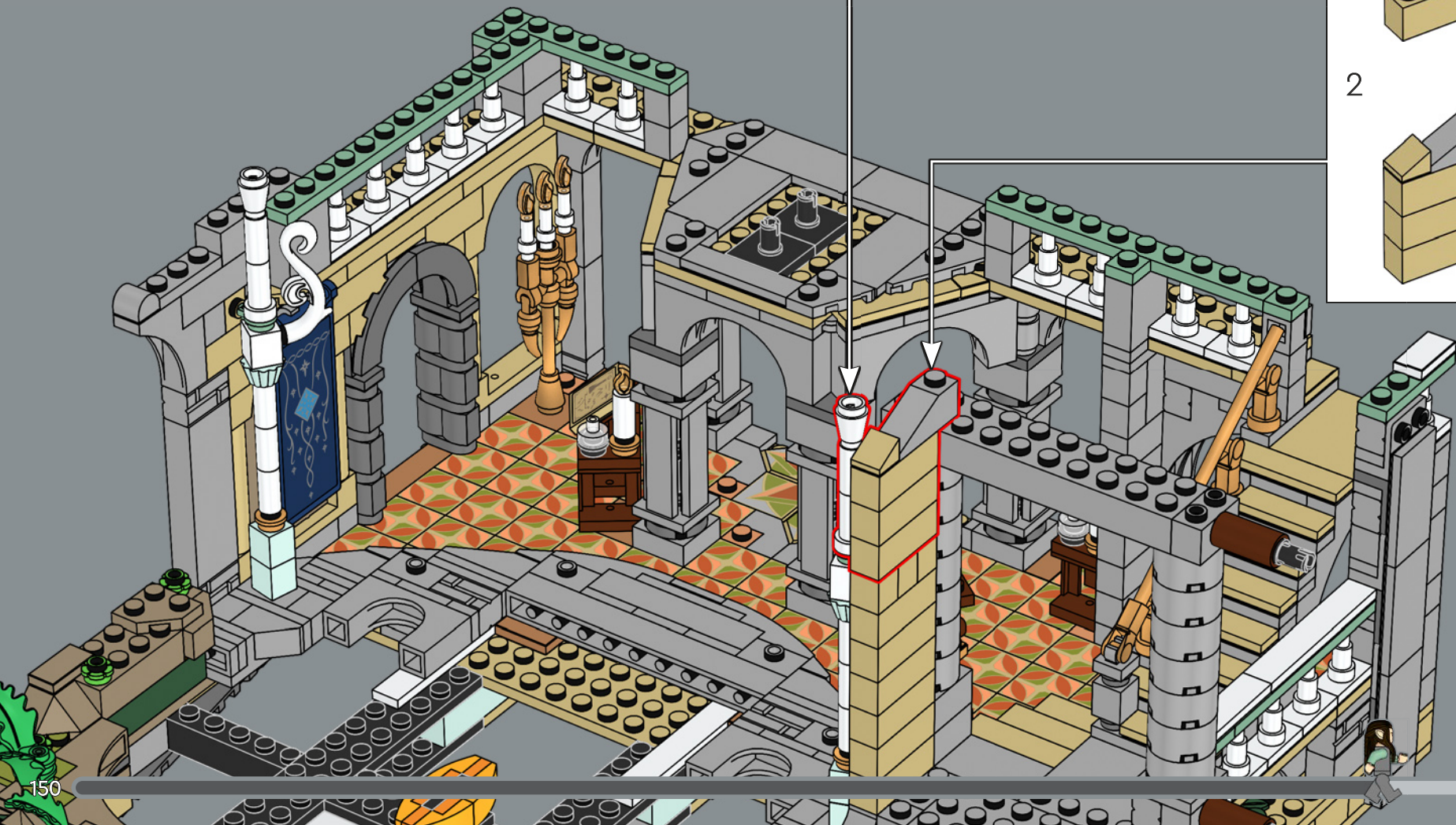
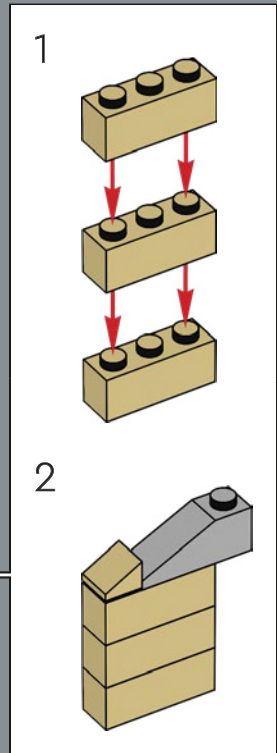
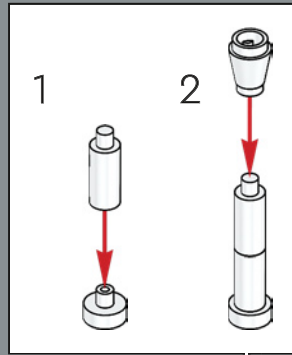

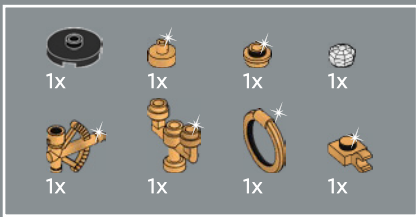

155

1

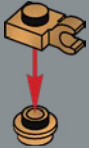

2



3



4

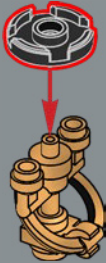

5

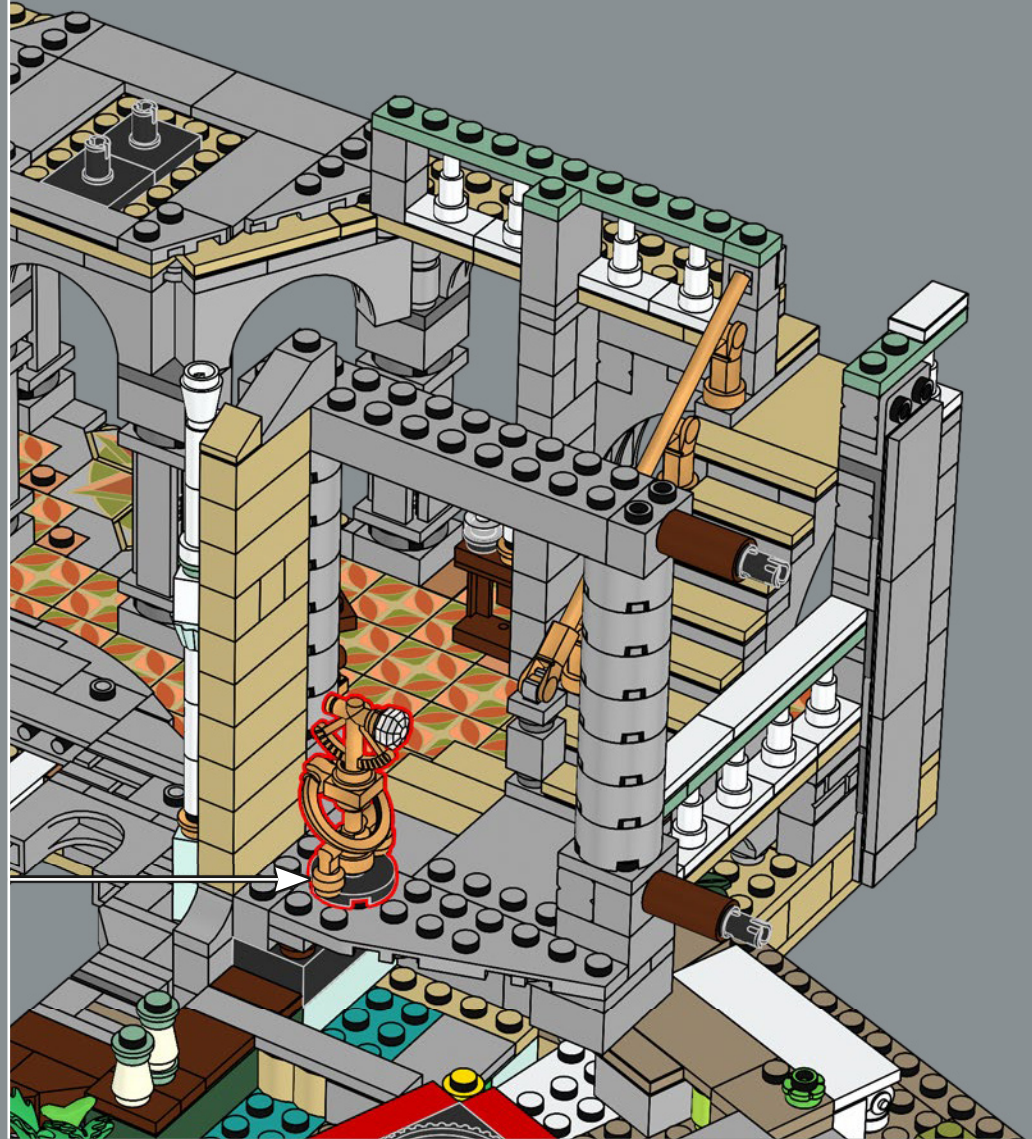
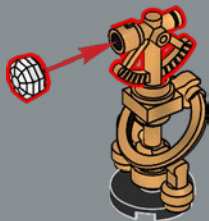



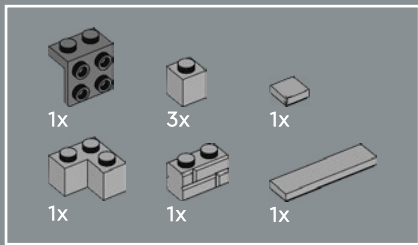

156

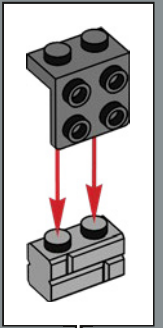

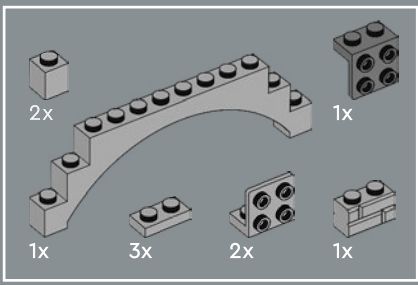

157

1

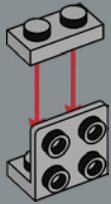

2

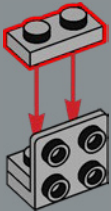

3

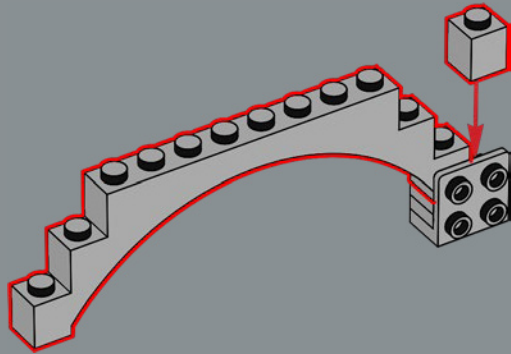

4

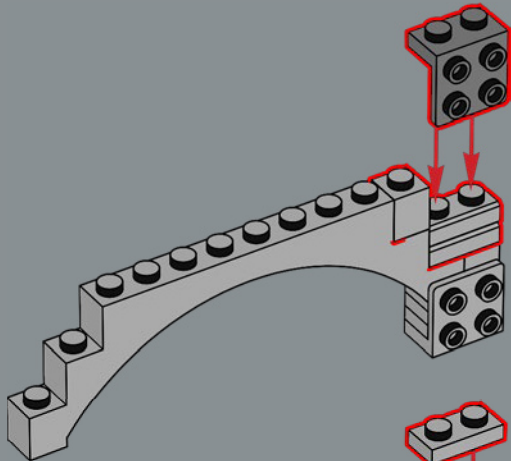

5

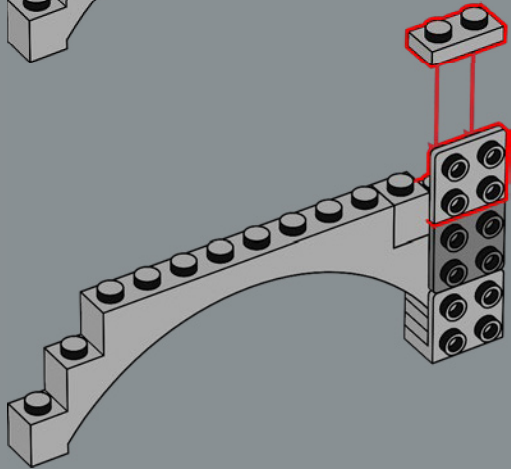



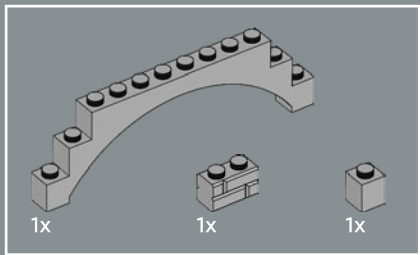

158

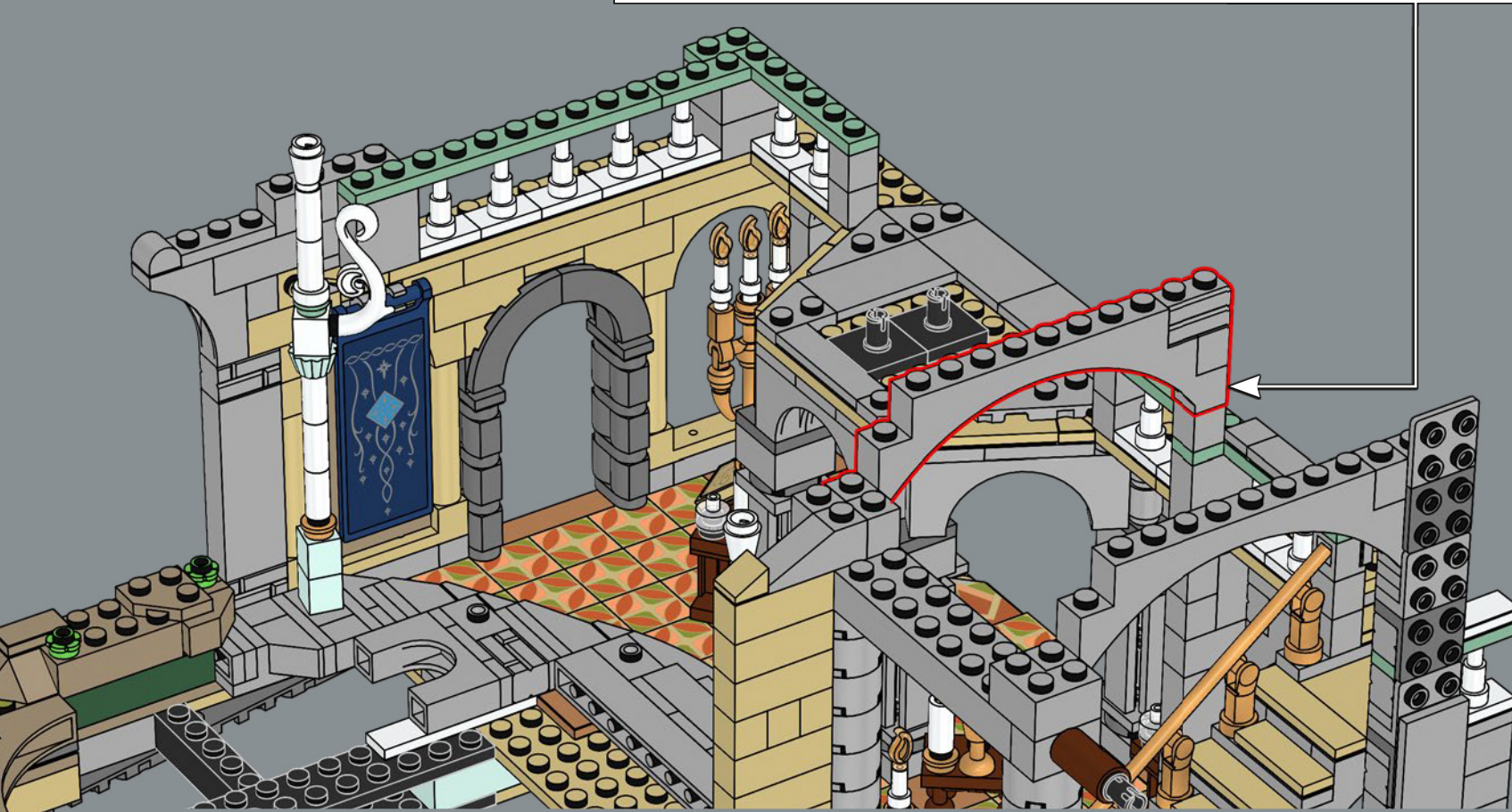
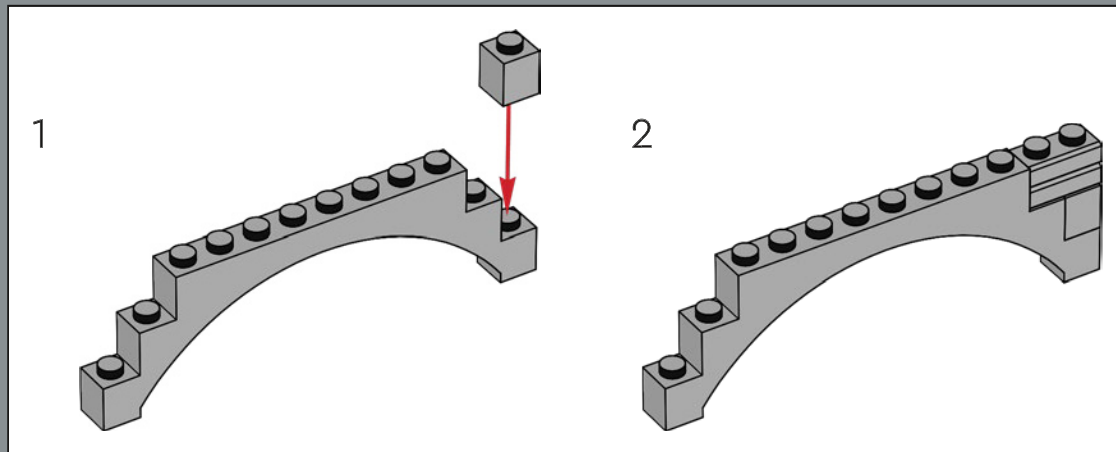

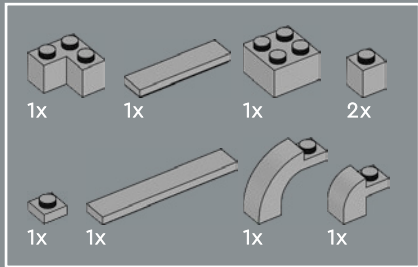

159

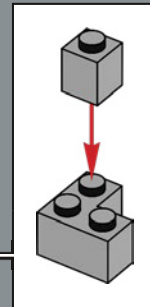
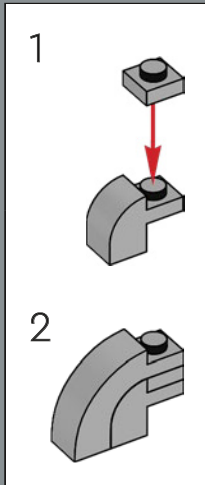

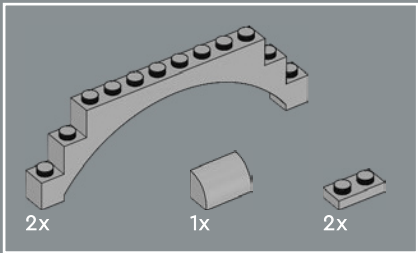

160

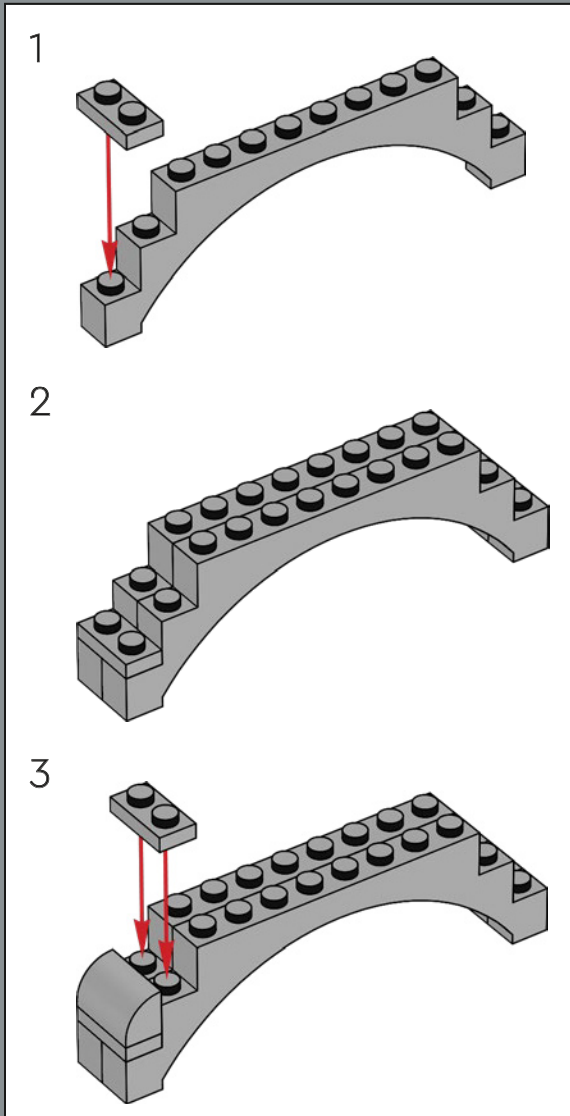

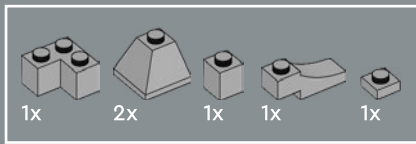

161

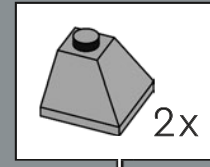
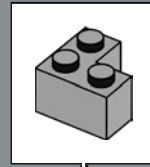
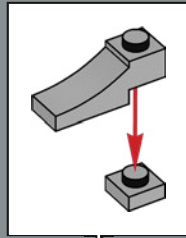

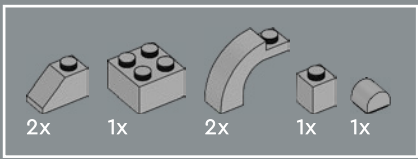

162

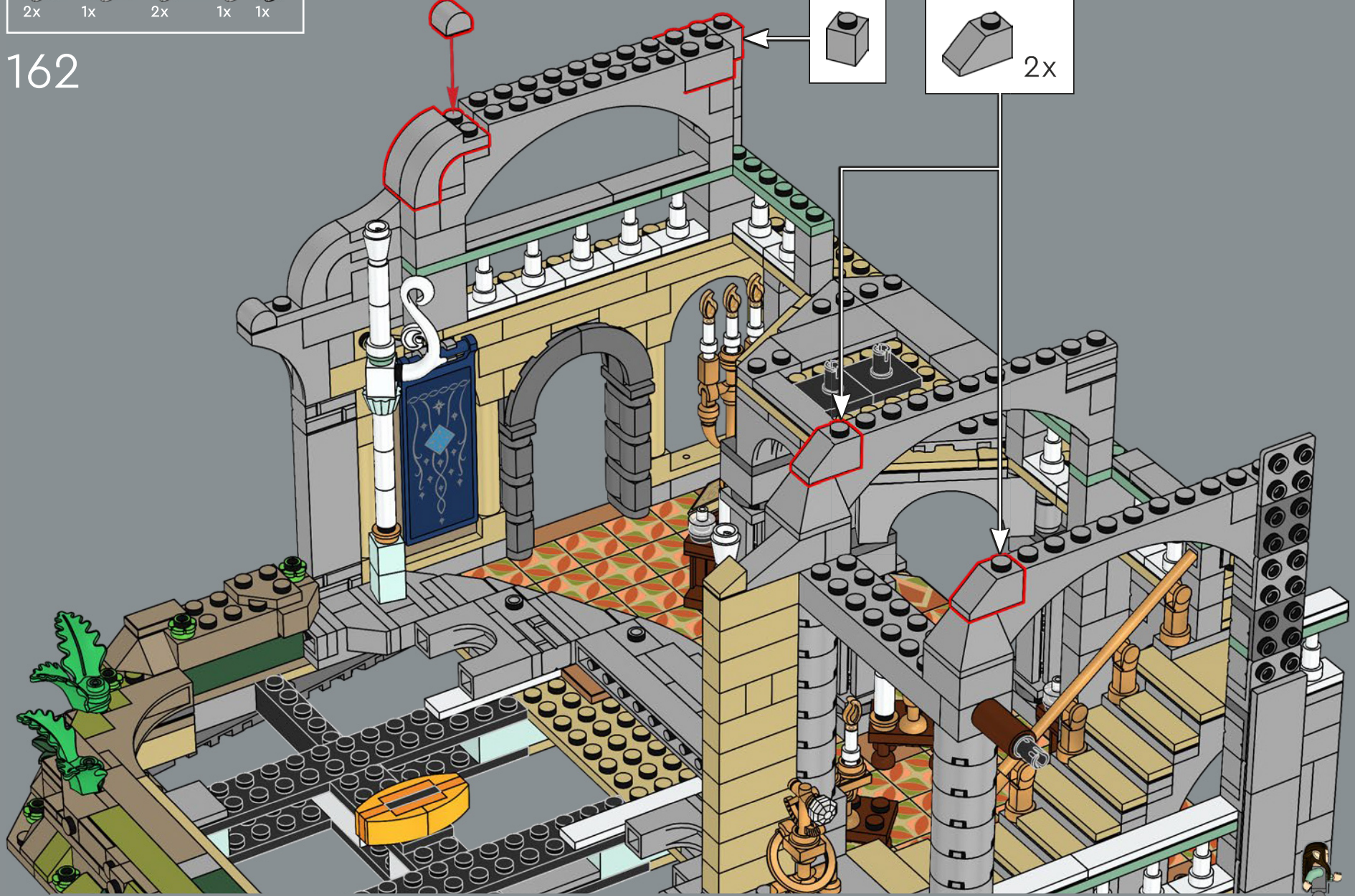
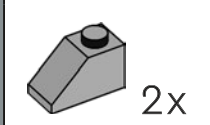
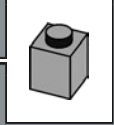

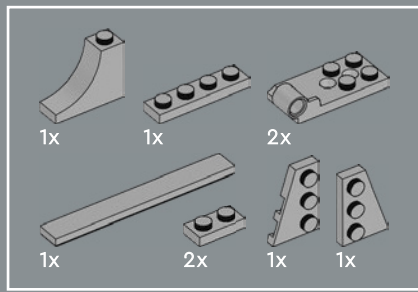

163

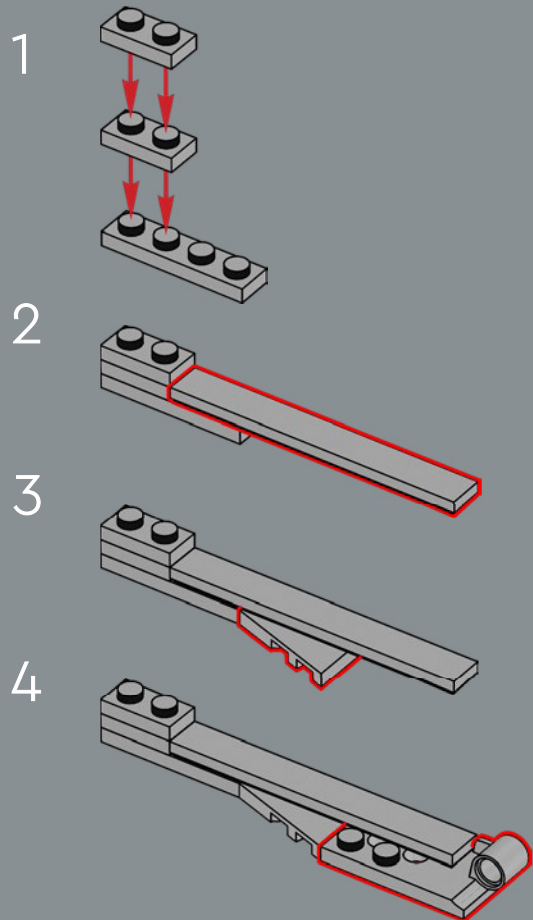

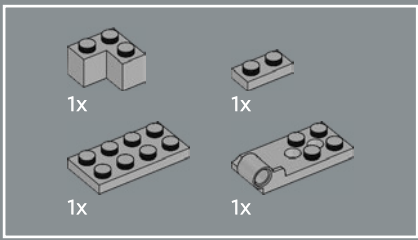

164



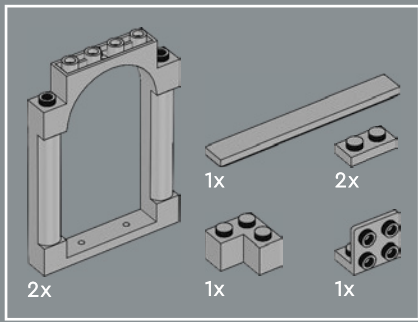

165

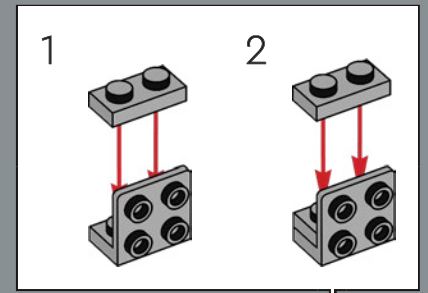

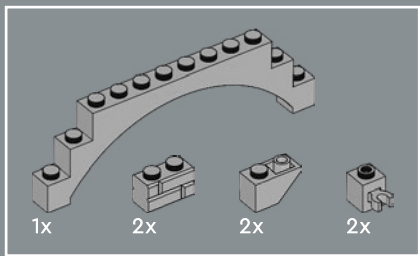

166

1

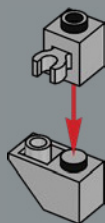

2

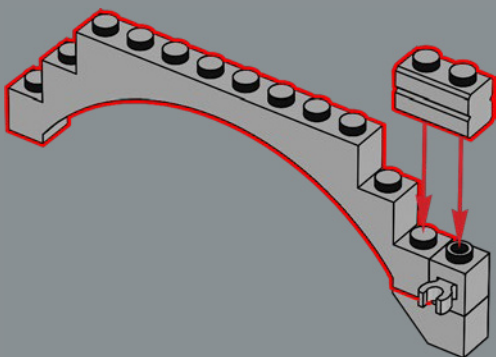

3

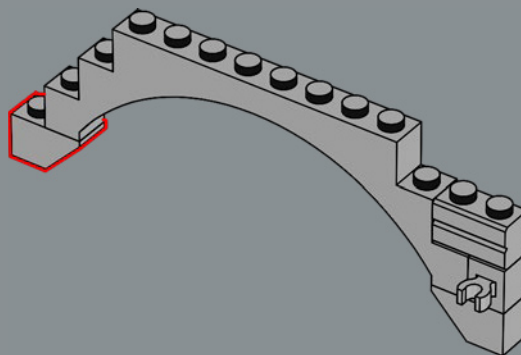

4

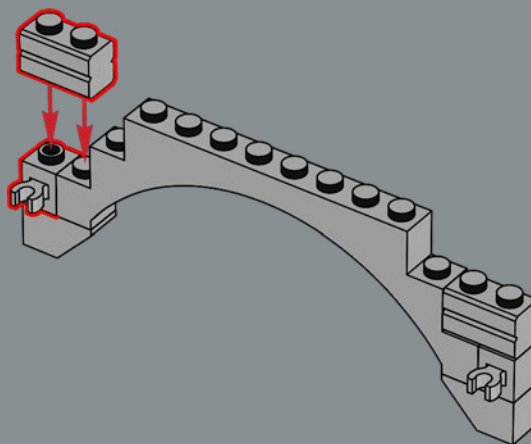

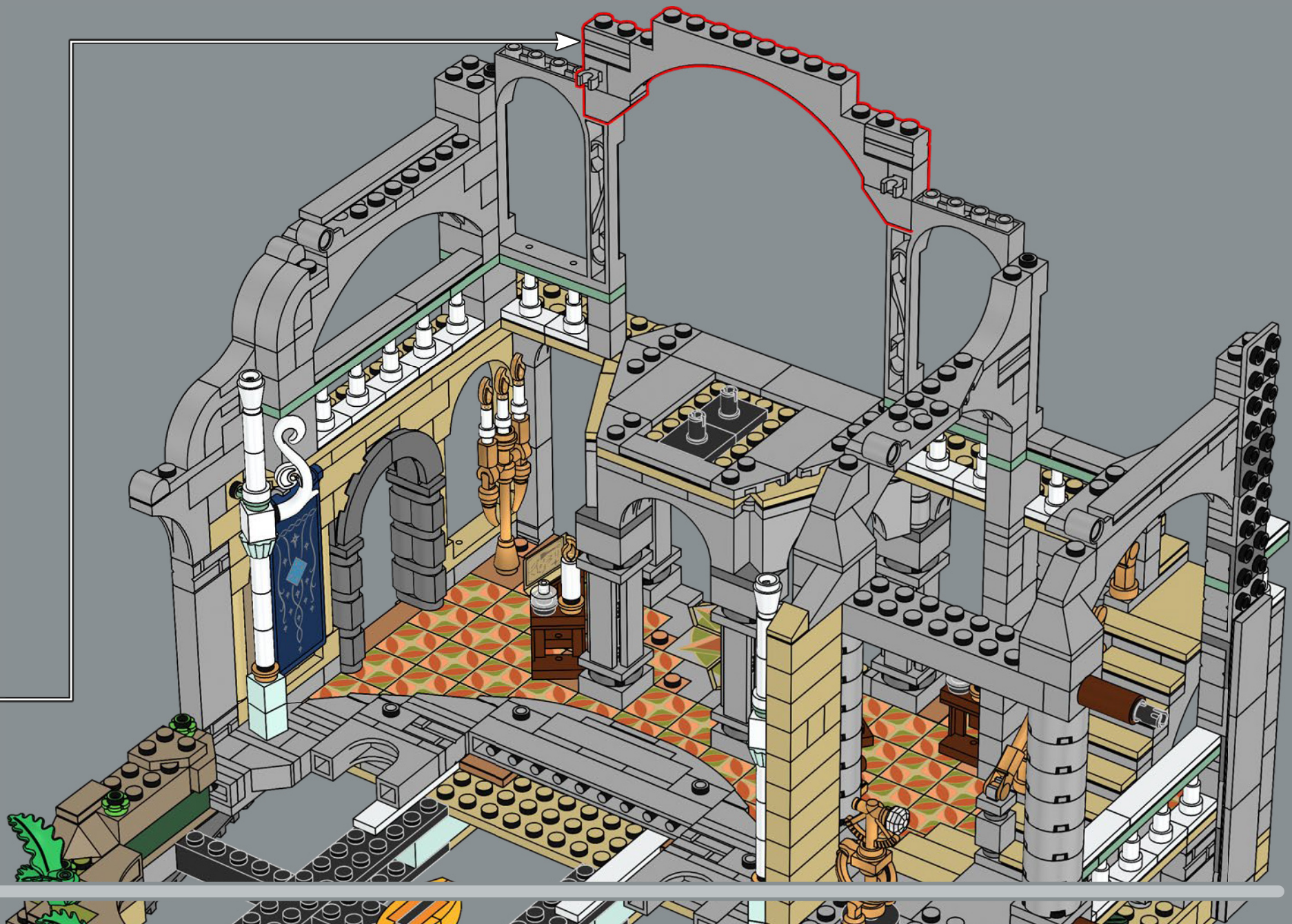

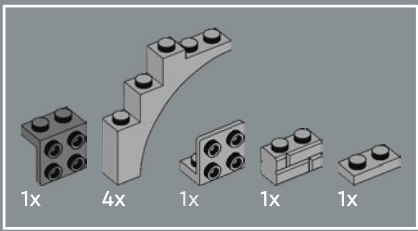

167

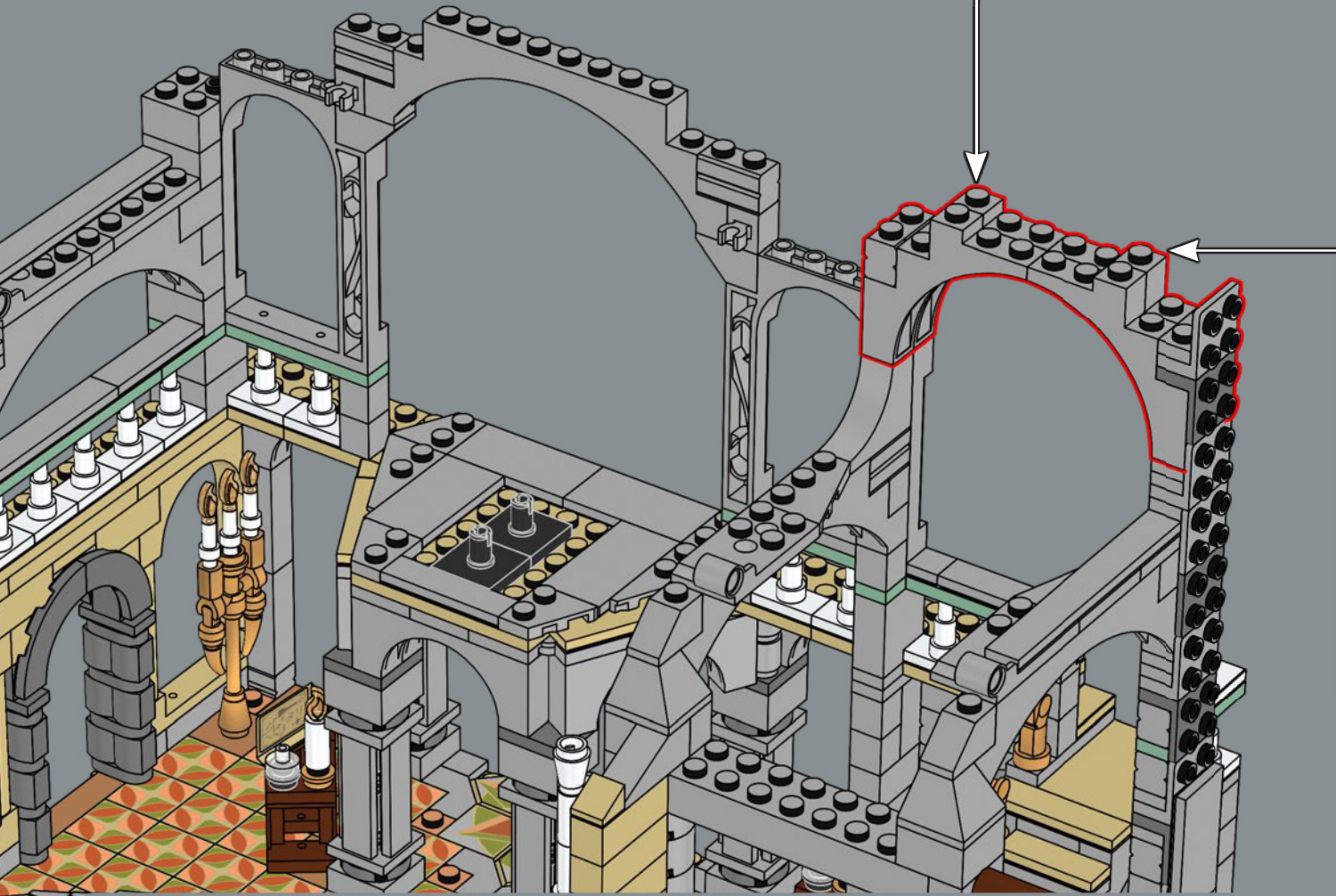
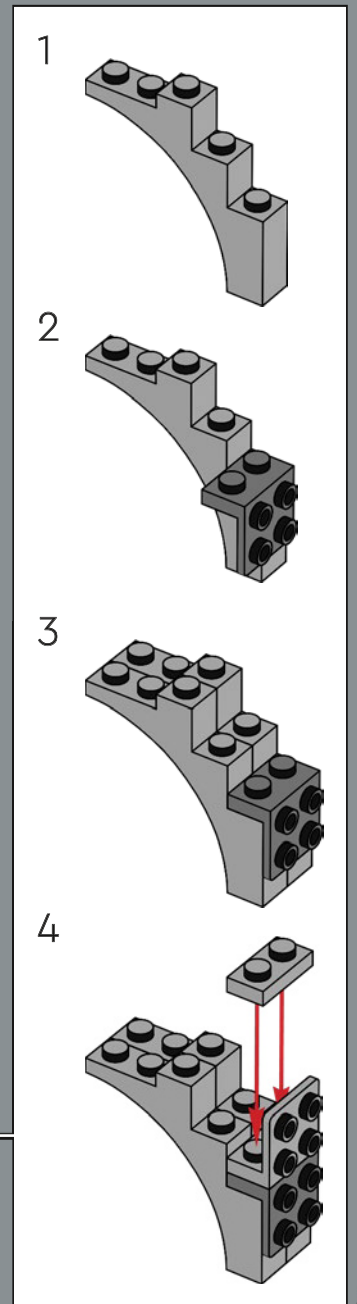
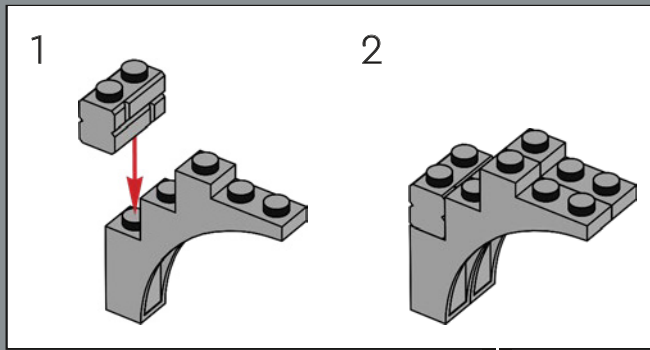

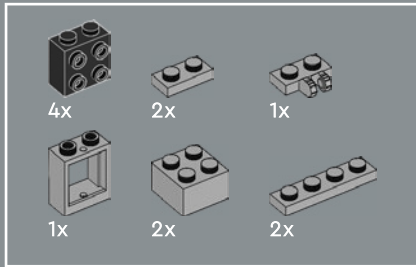

168

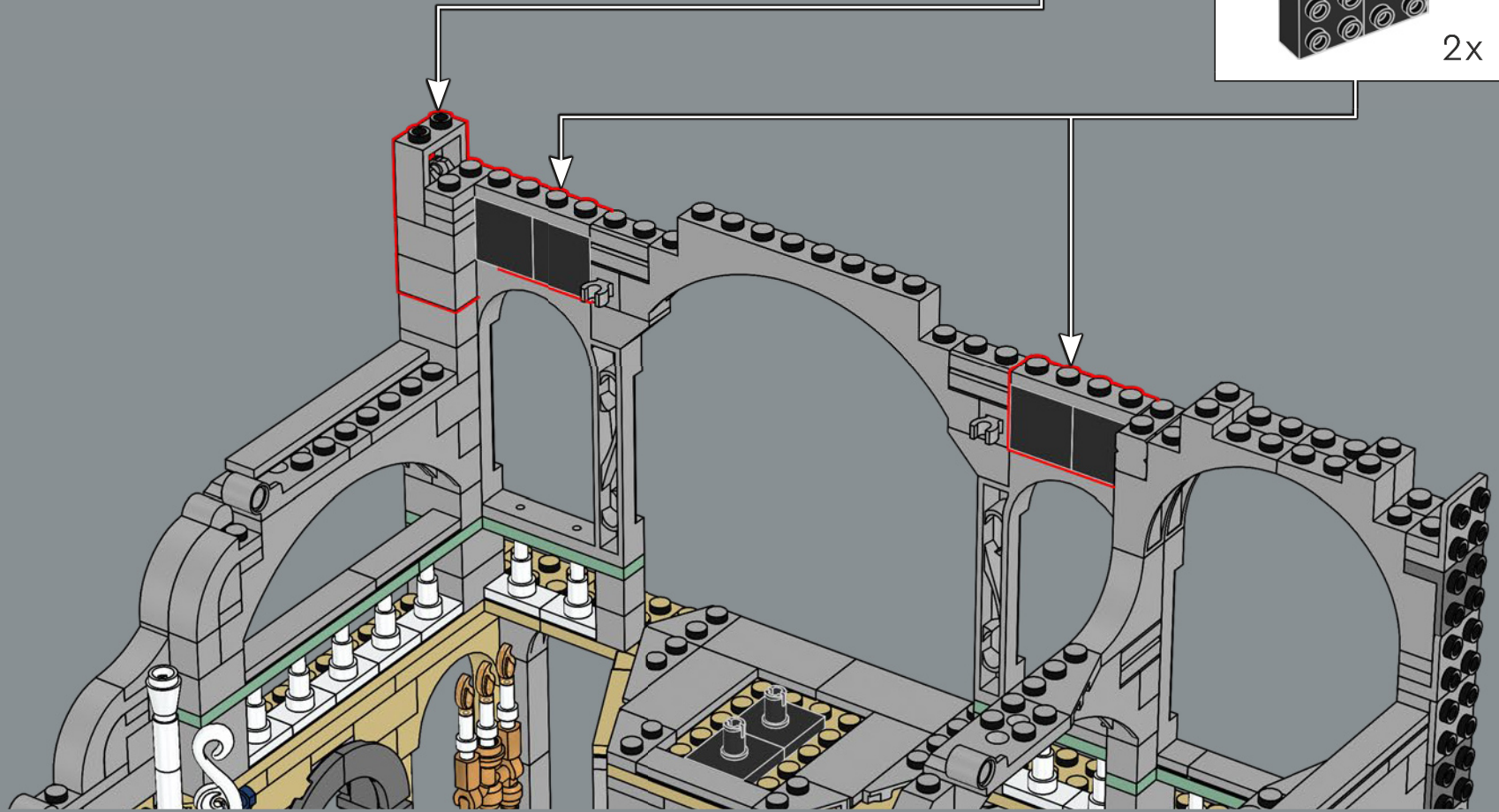
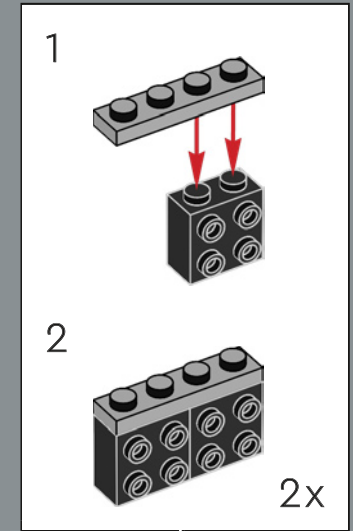
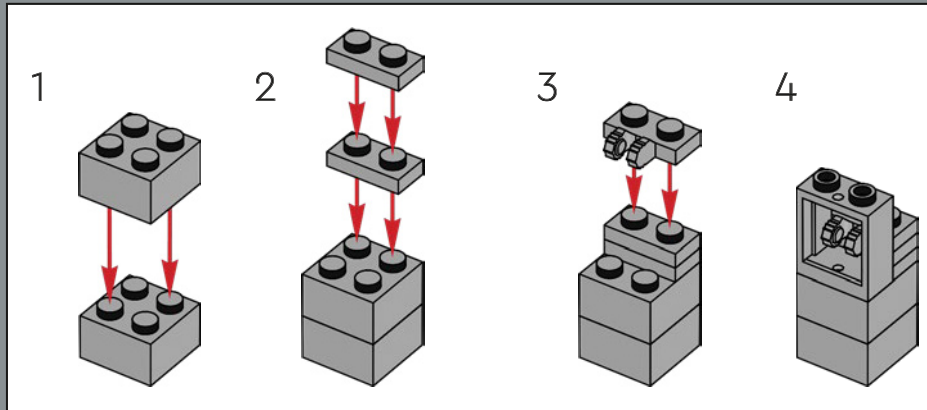

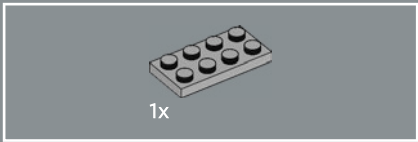

169

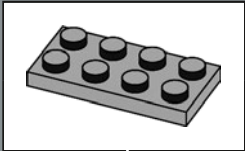

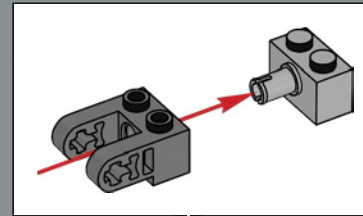
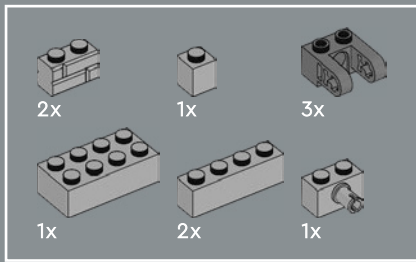

Die Klickverbindung an diesen 2x4 Scharnieren ist so positioniert, dass sie genau 10 Module von den oberen Kreuzachsenlöchern entfernt ist.

170

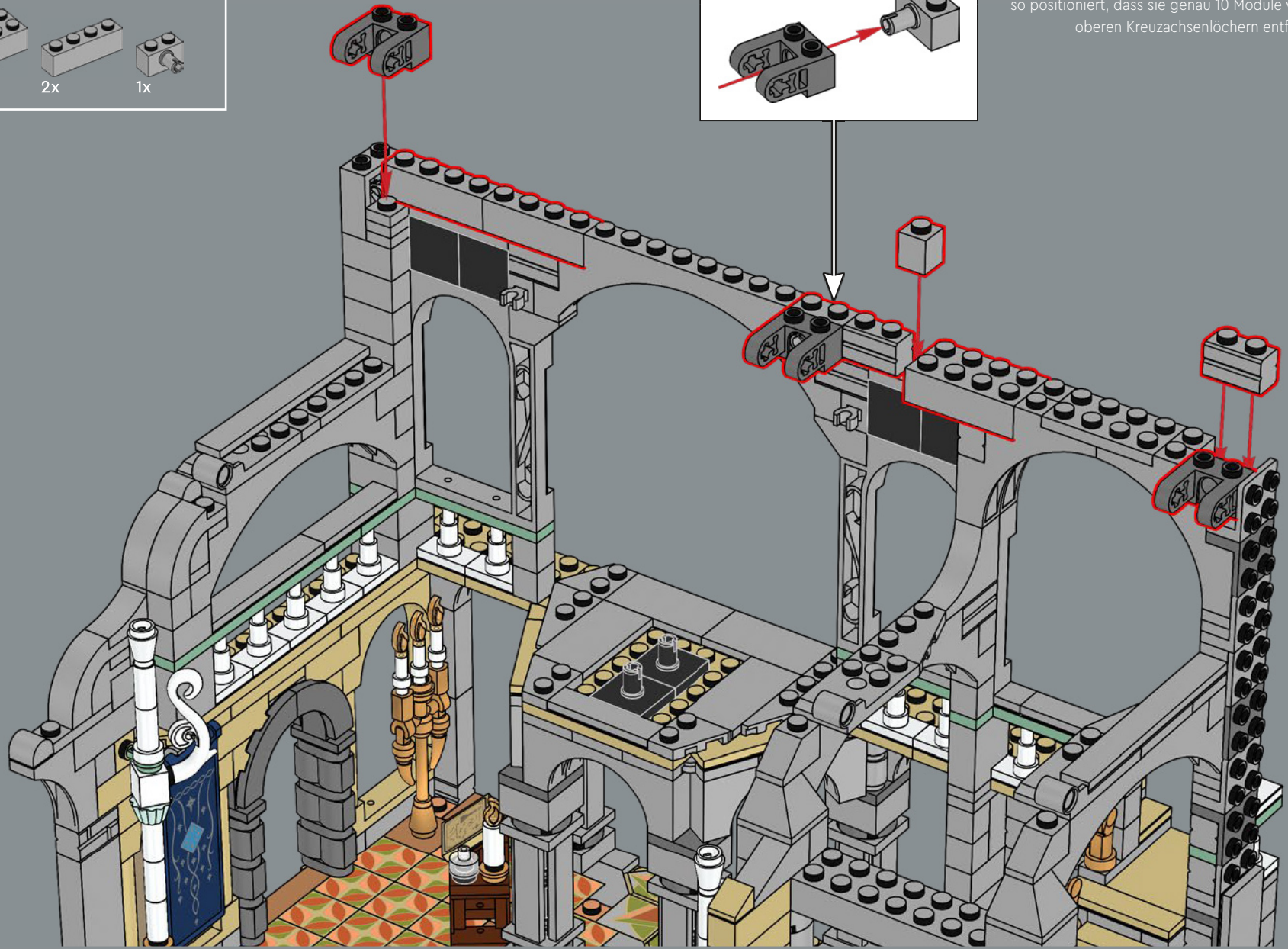

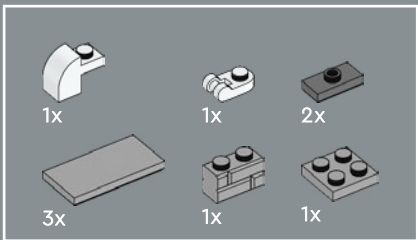

171

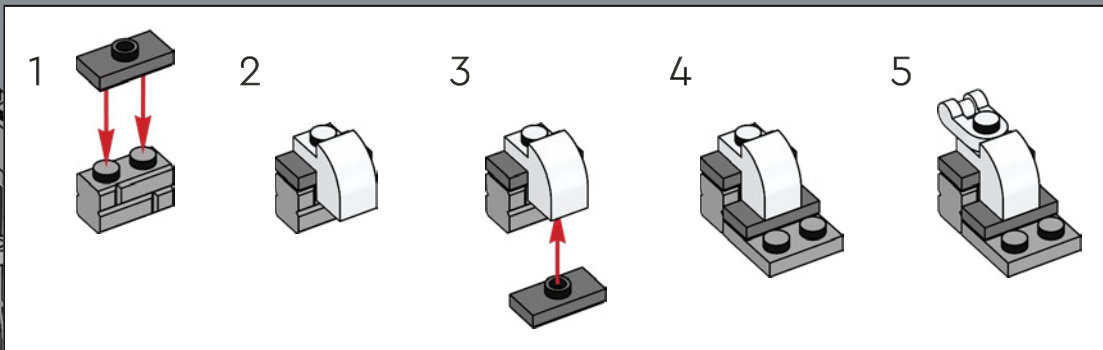

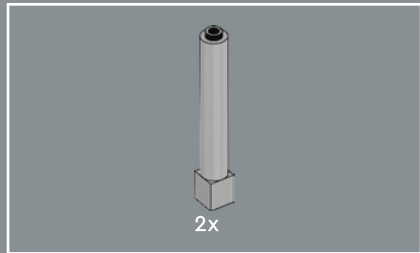

172

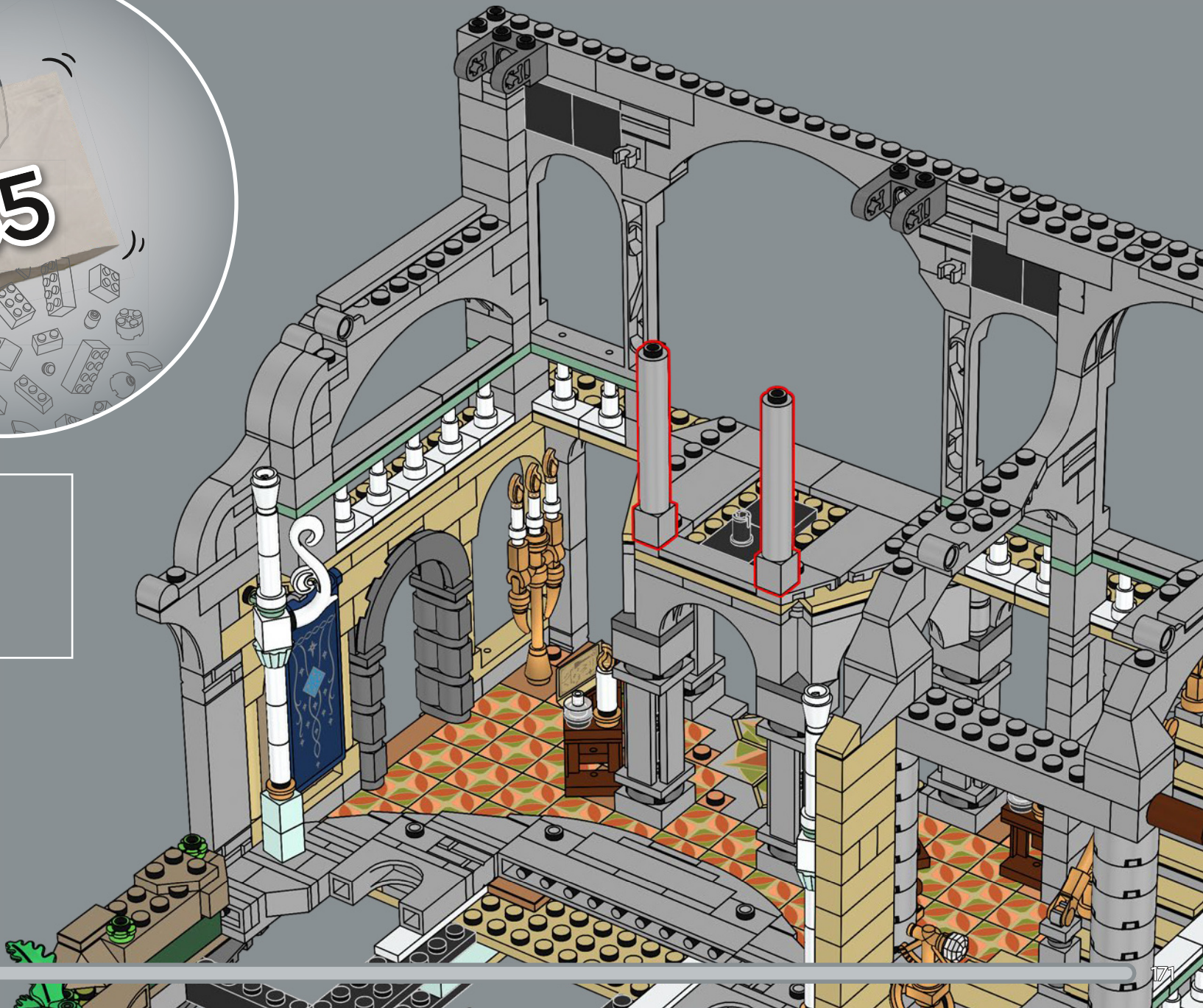

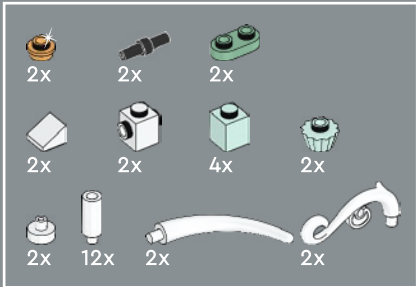
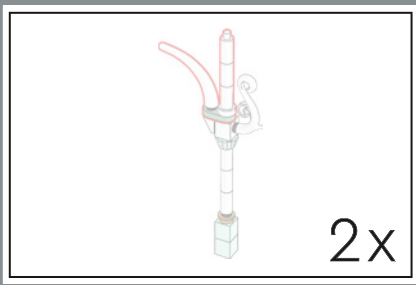

173

1



2



3



4





Das hier verwendete Zierelement wurde ursprünglich entwickelt, um LEGO® Elves Figuren (2017) einen magischen Effekt zu verleihen.

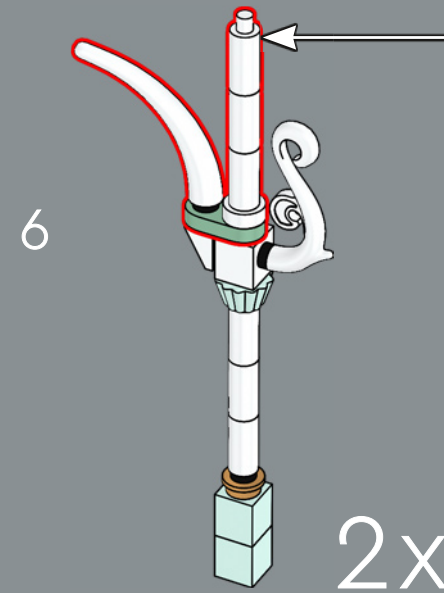
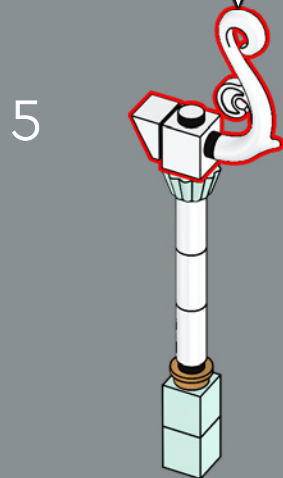
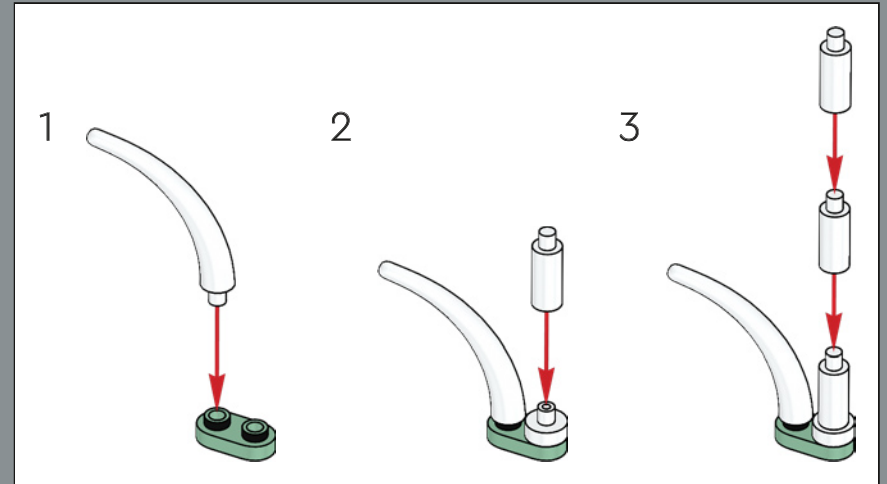
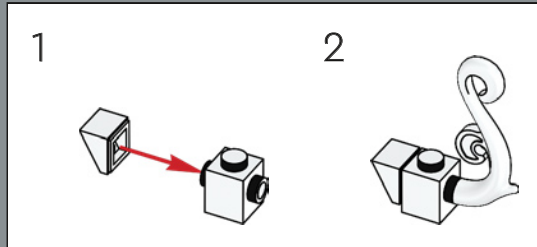

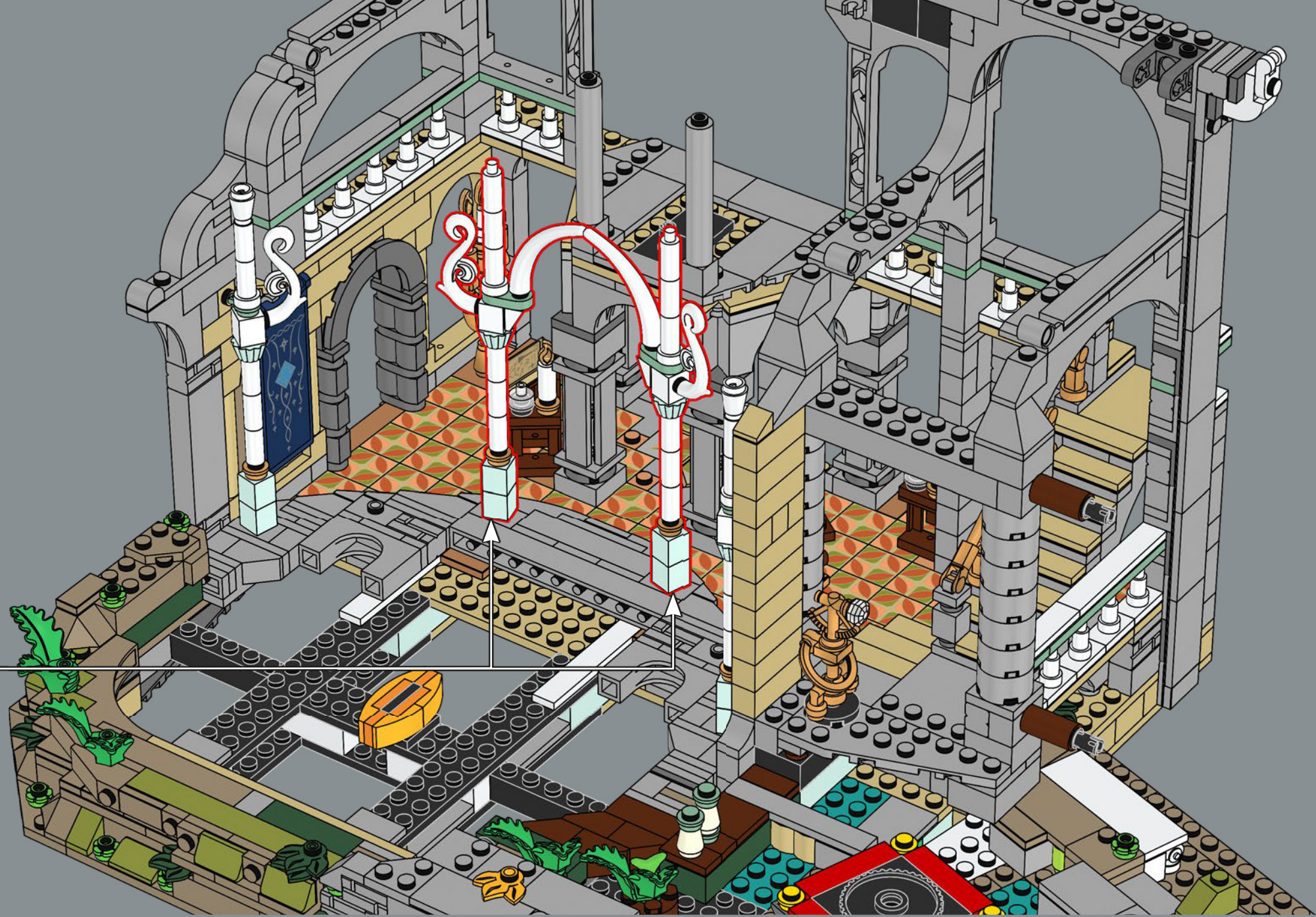

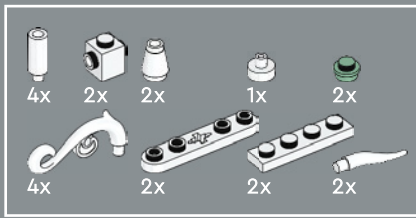

174

1

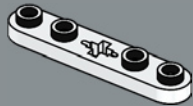

2

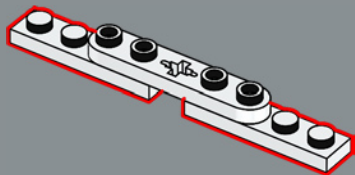

3

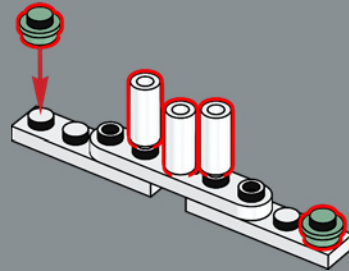

4

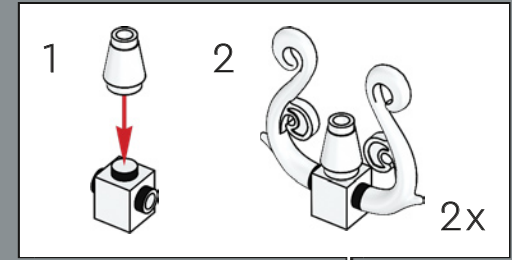
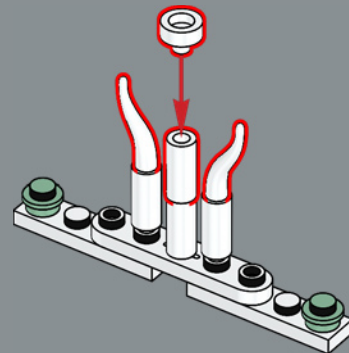

5

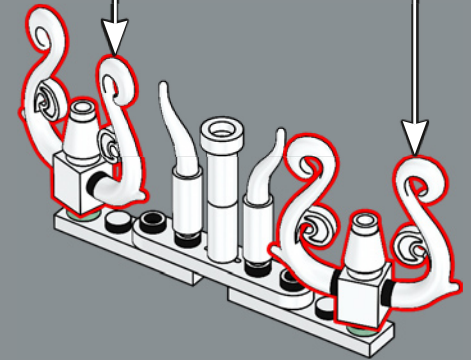

6

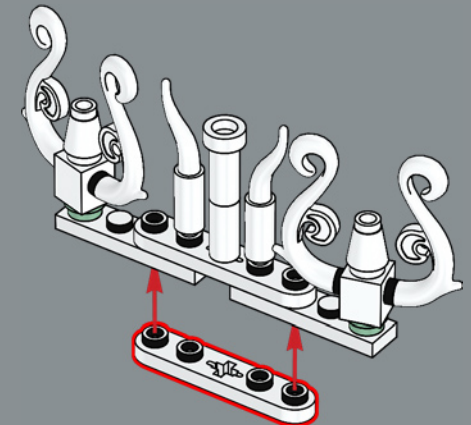

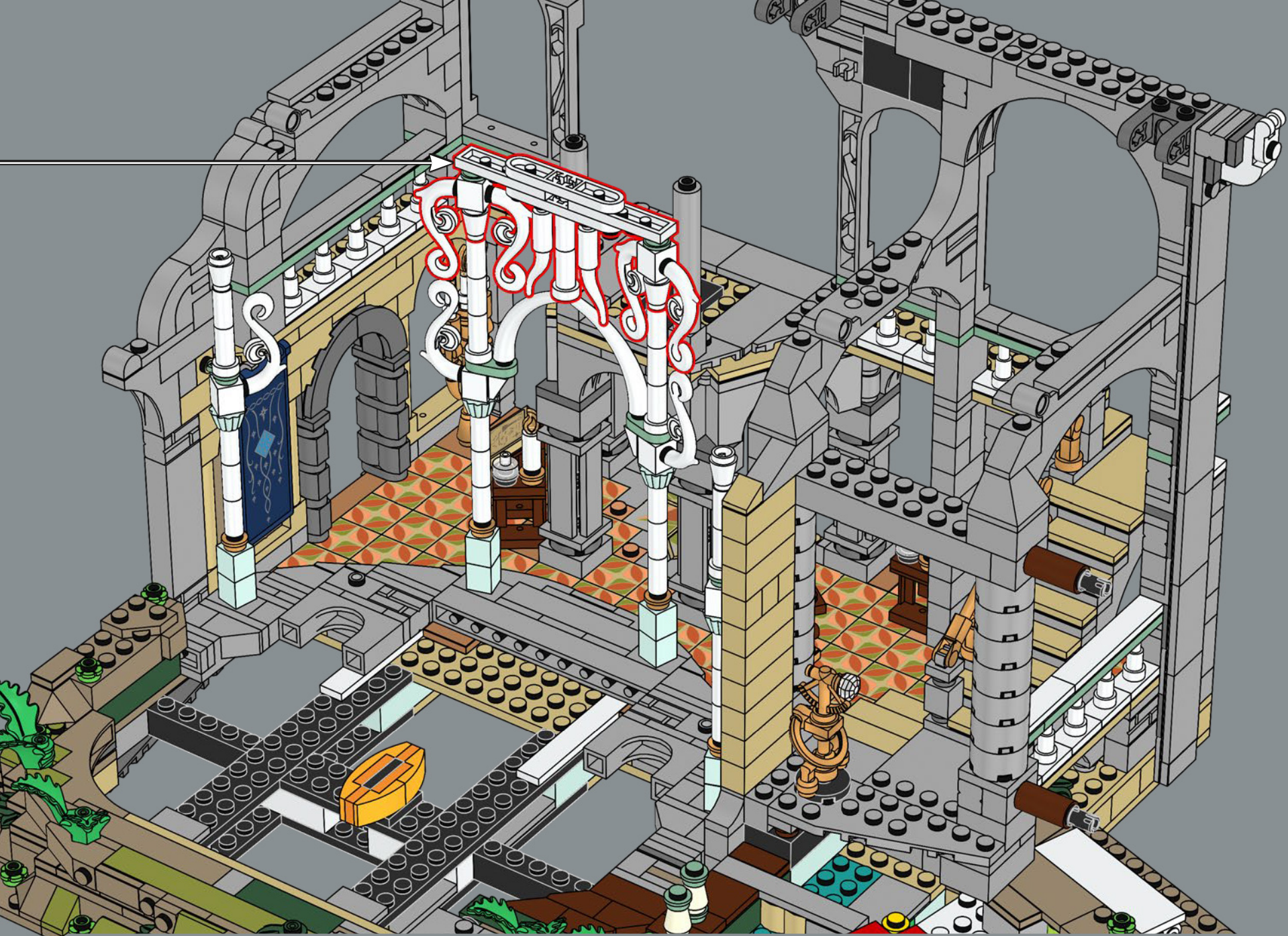

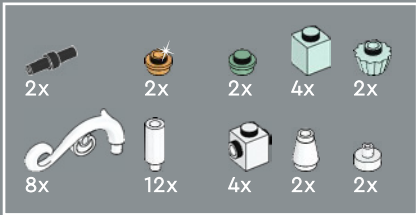
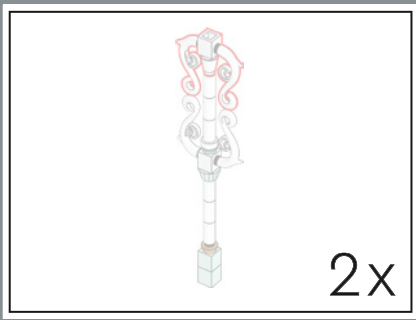

175

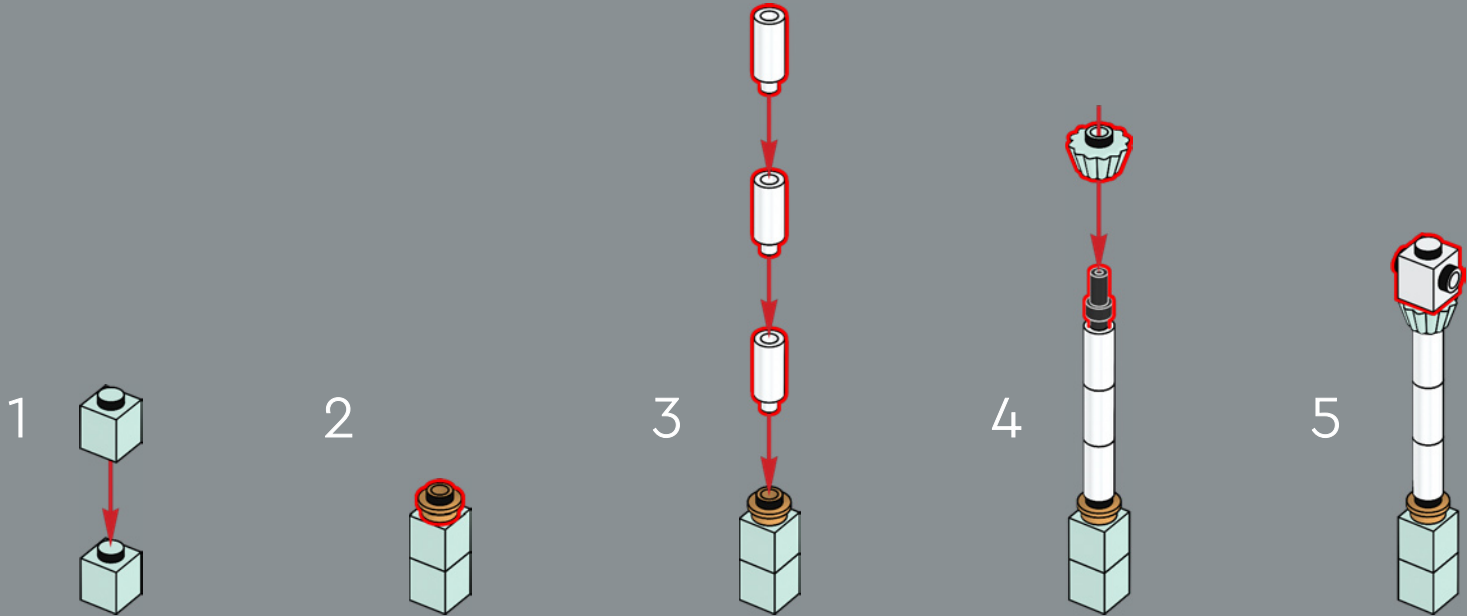

6

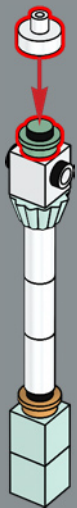

7

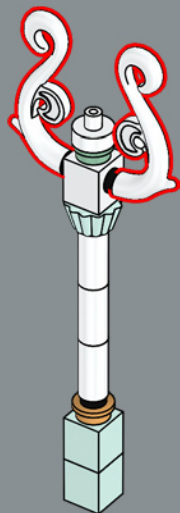

8

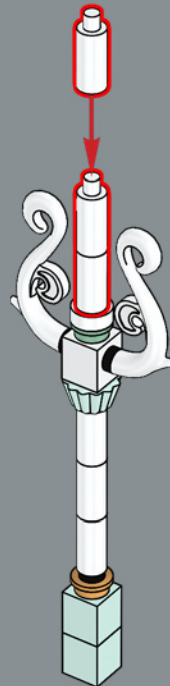

9

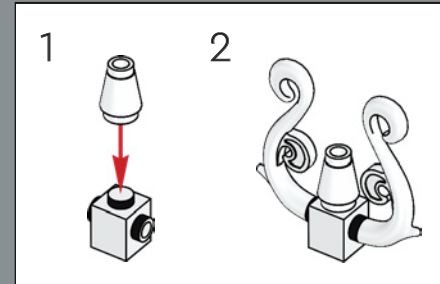
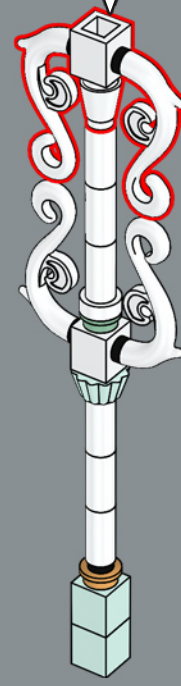

2x



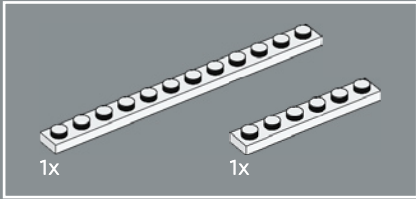
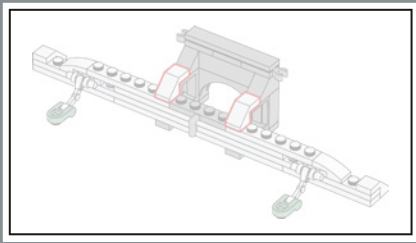

176

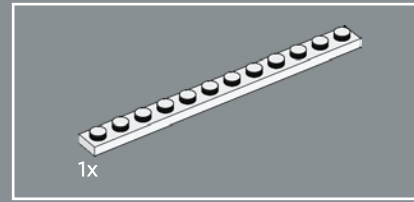
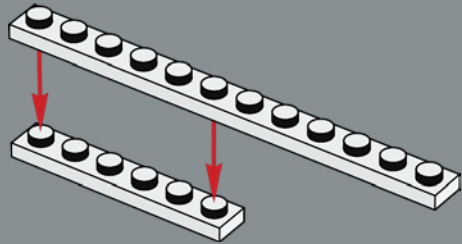

177

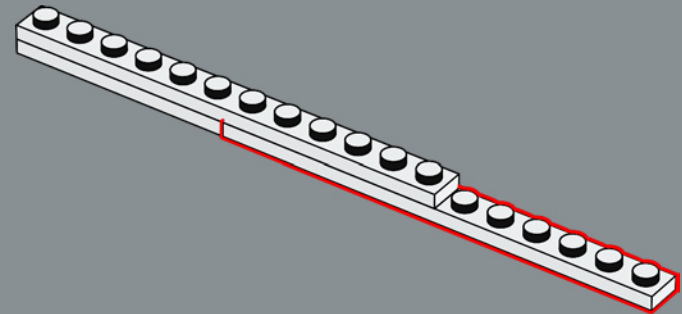

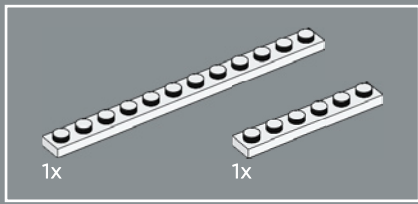

178

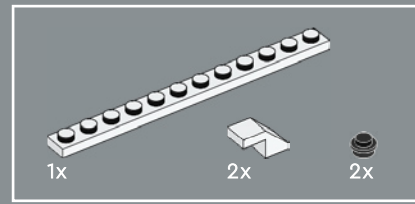
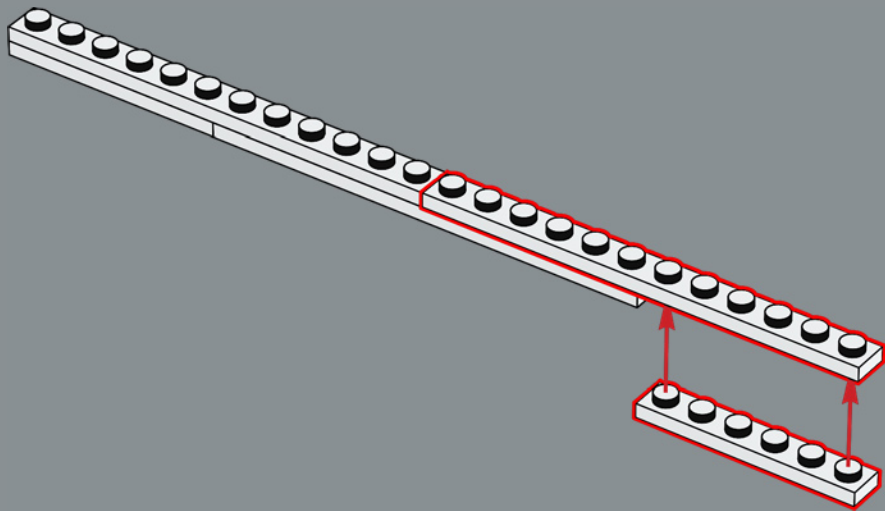

179

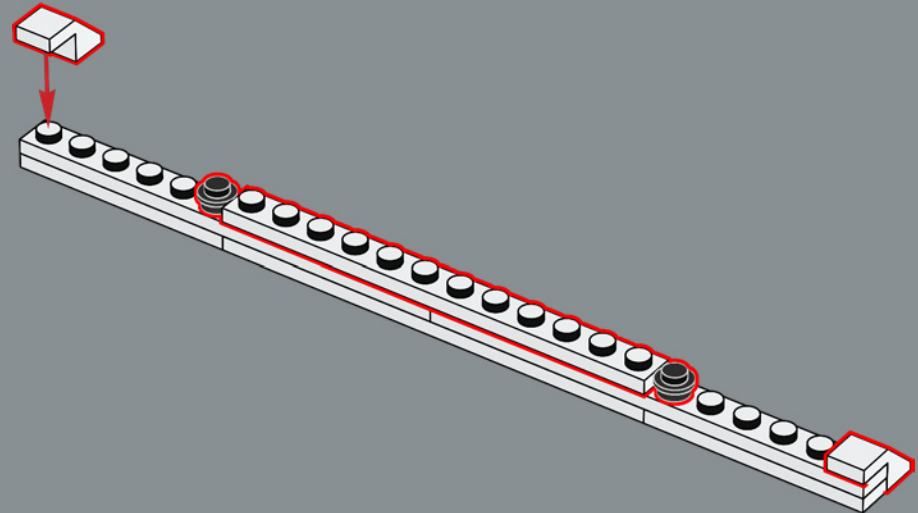



180

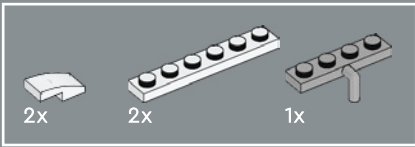
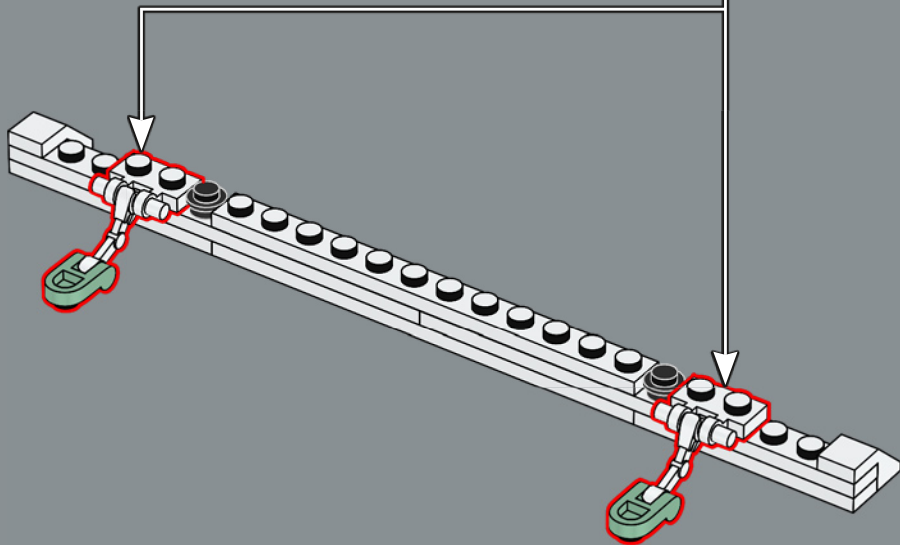
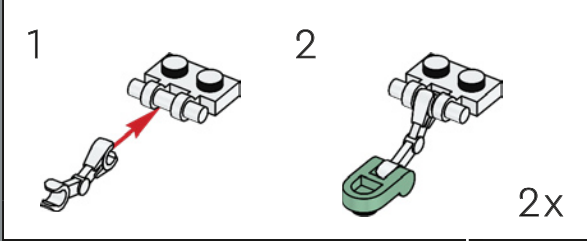

181

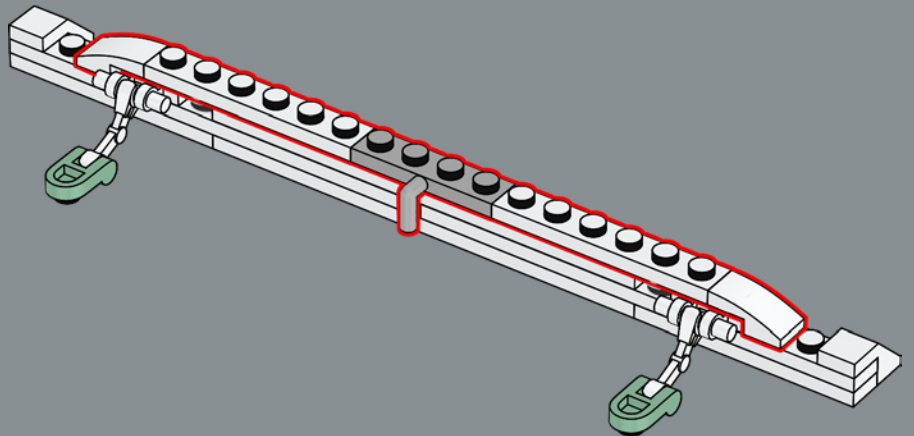

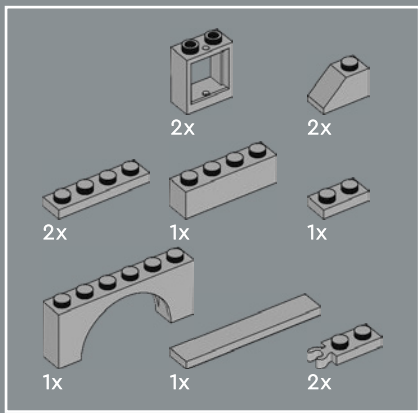

182

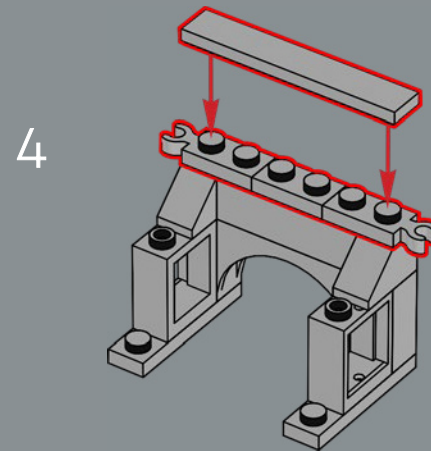
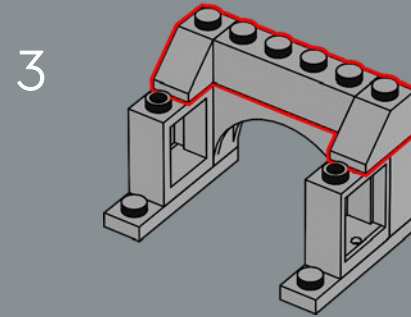
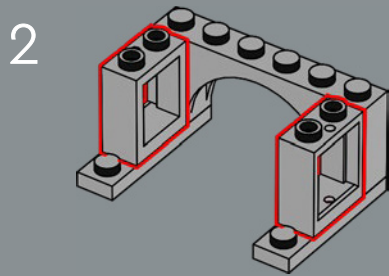
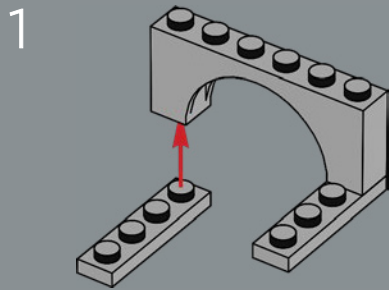

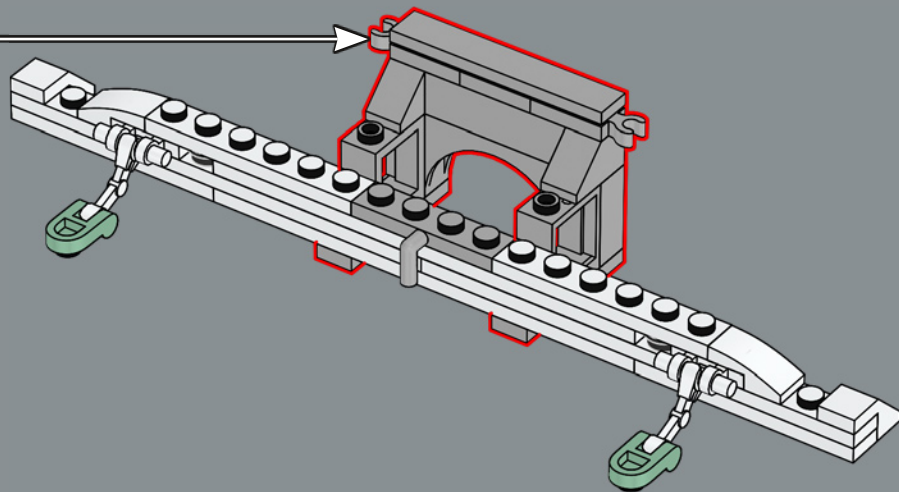

2x

183

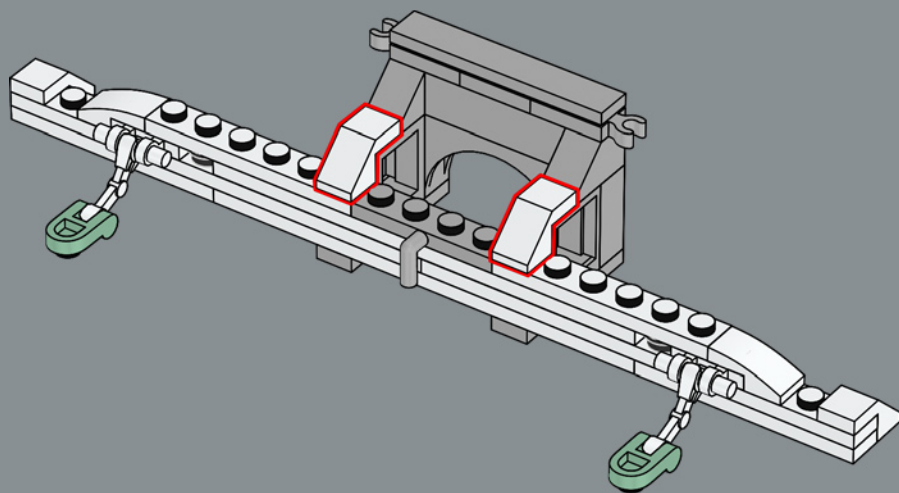

184

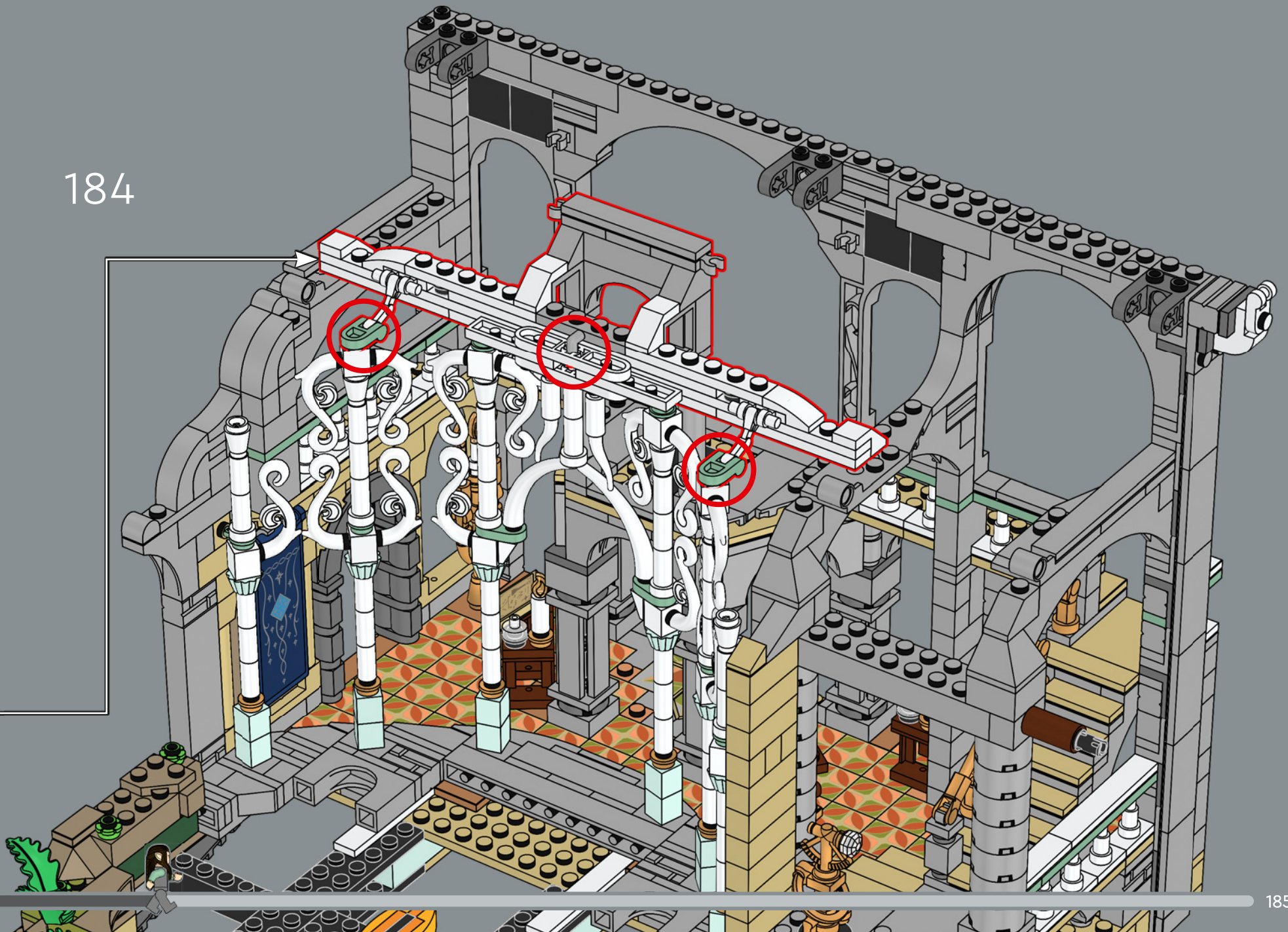

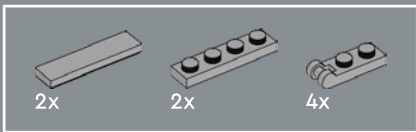

185

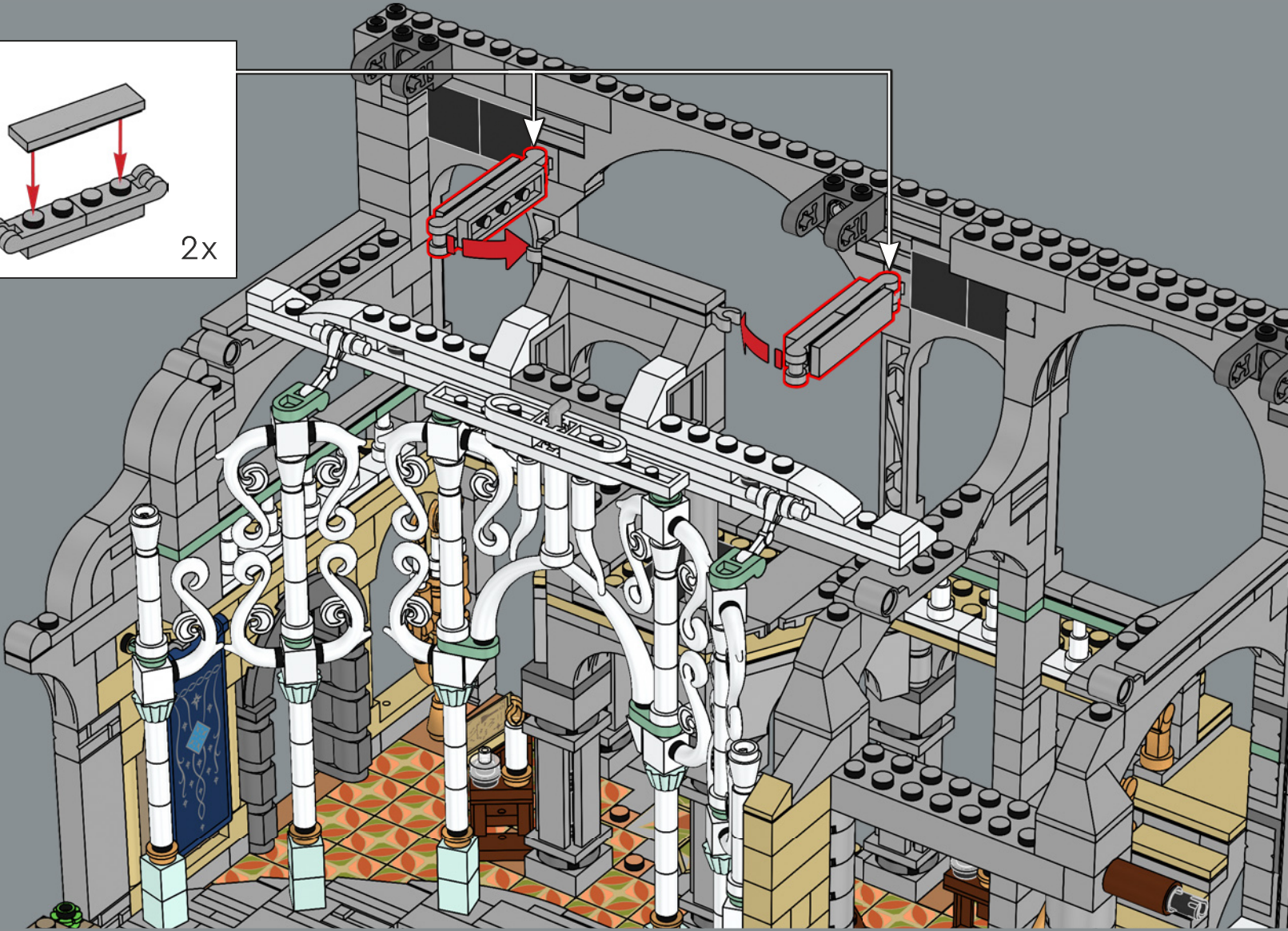
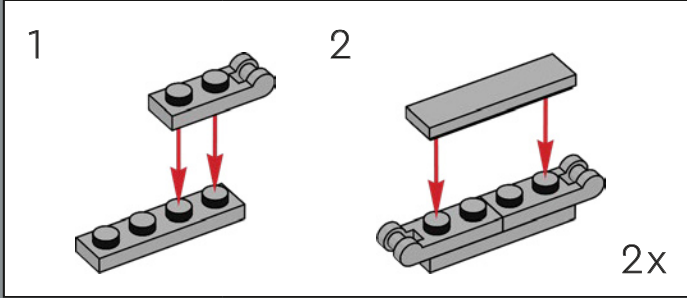

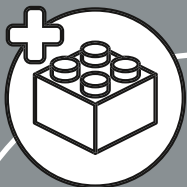

36

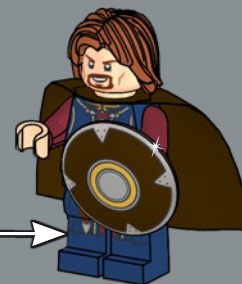
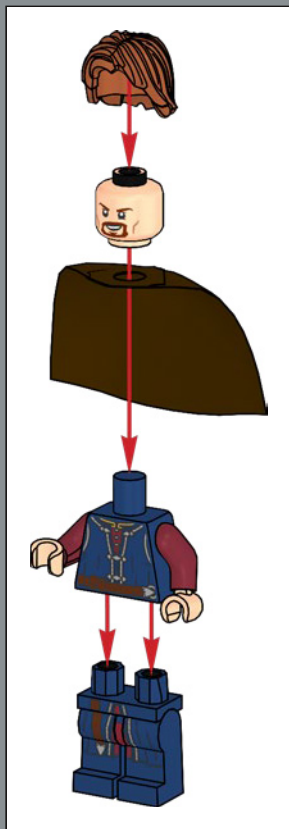

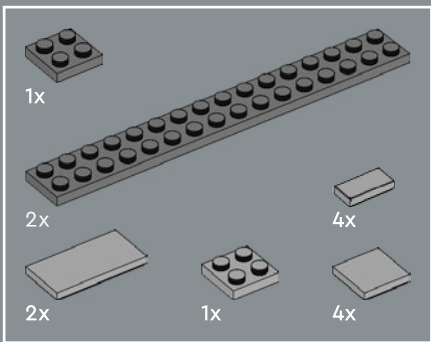

186

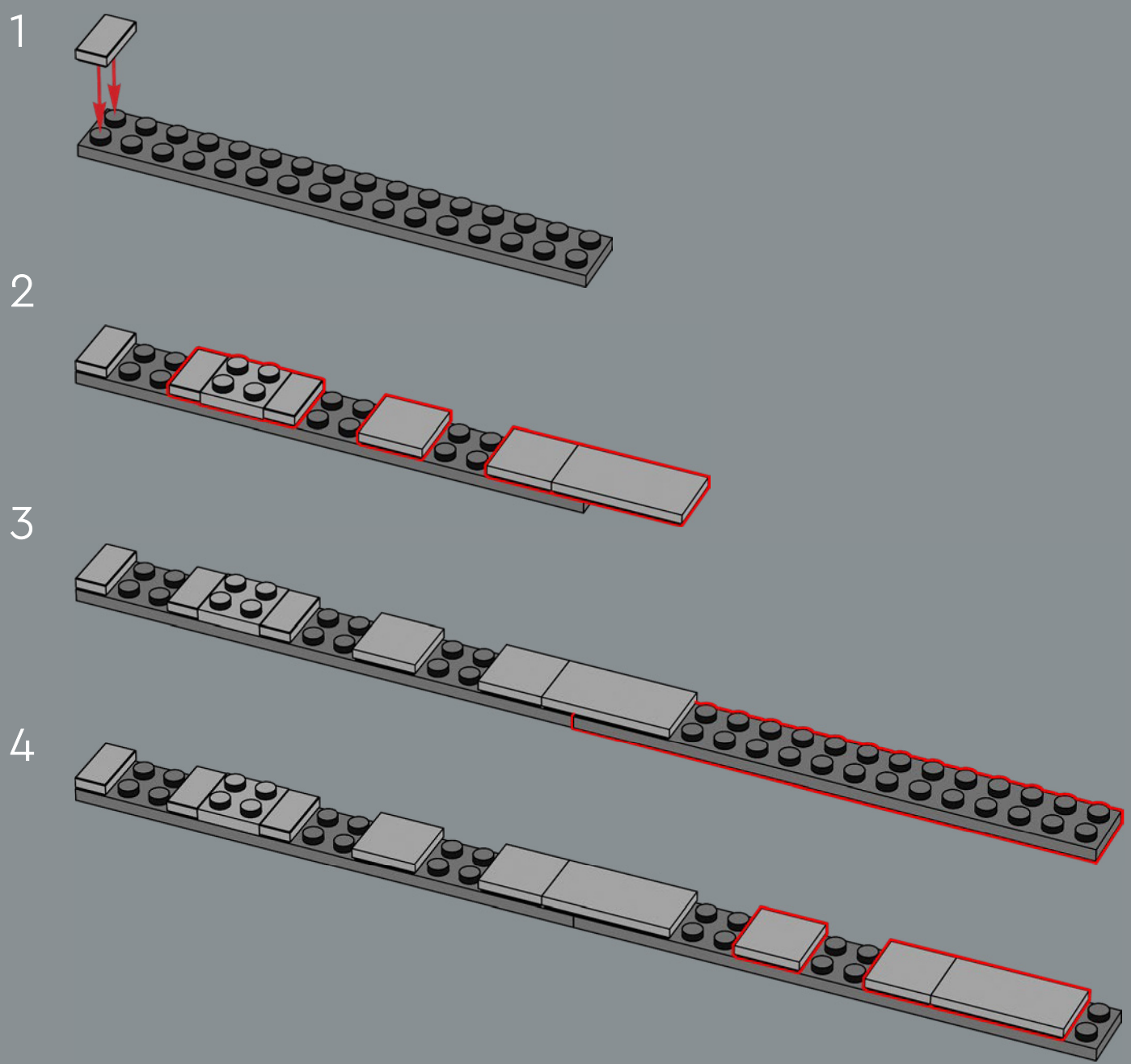

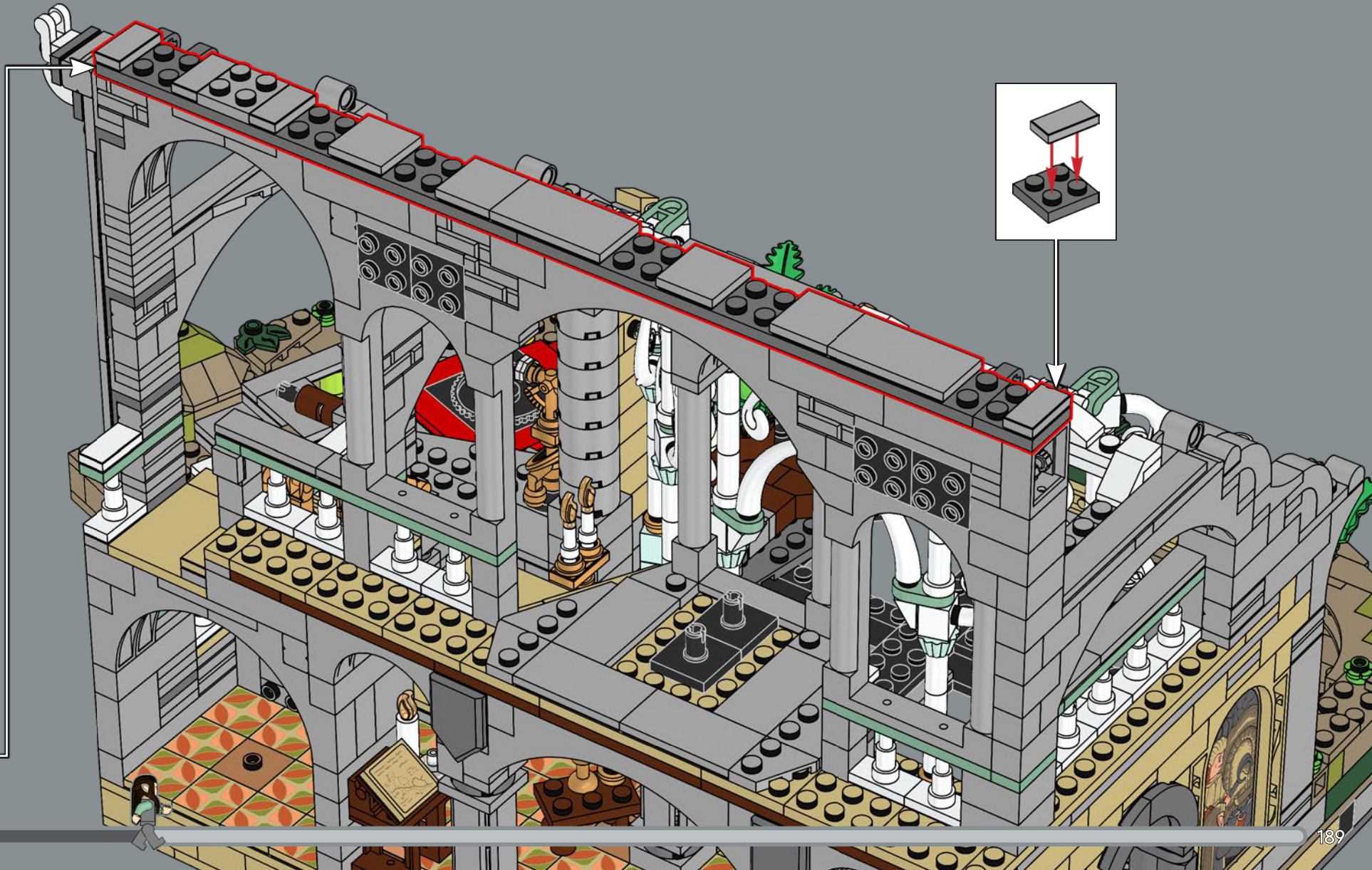

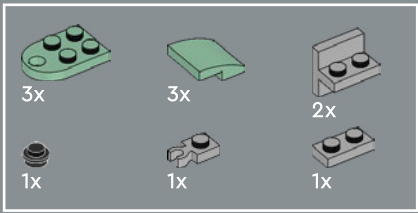

187

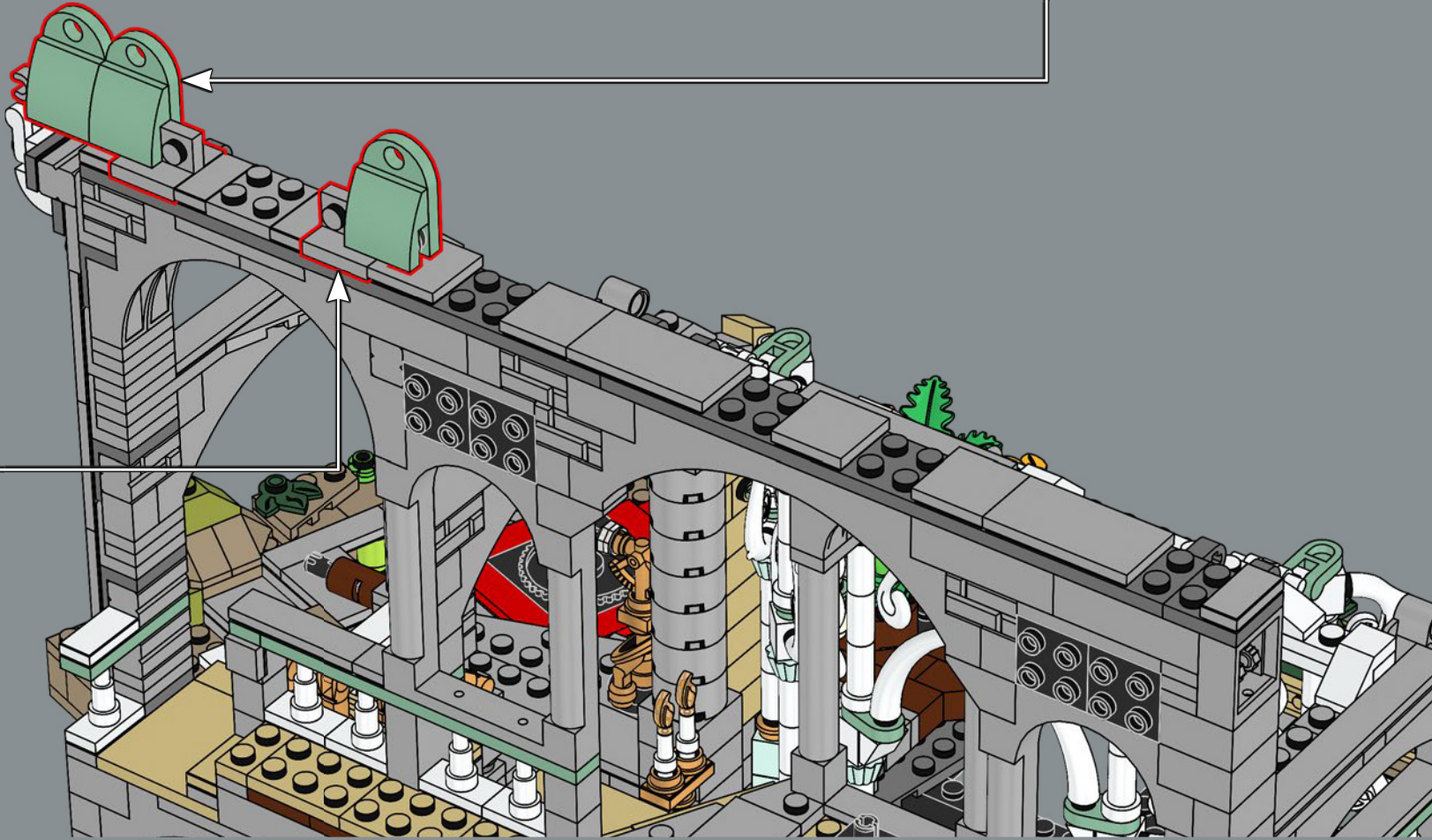
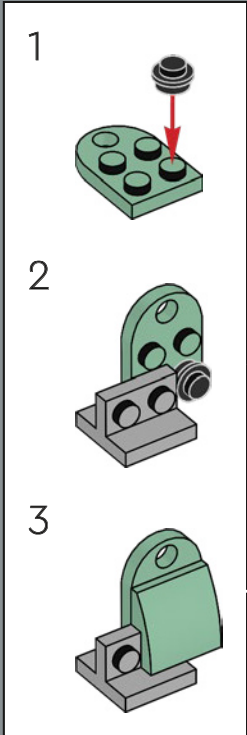
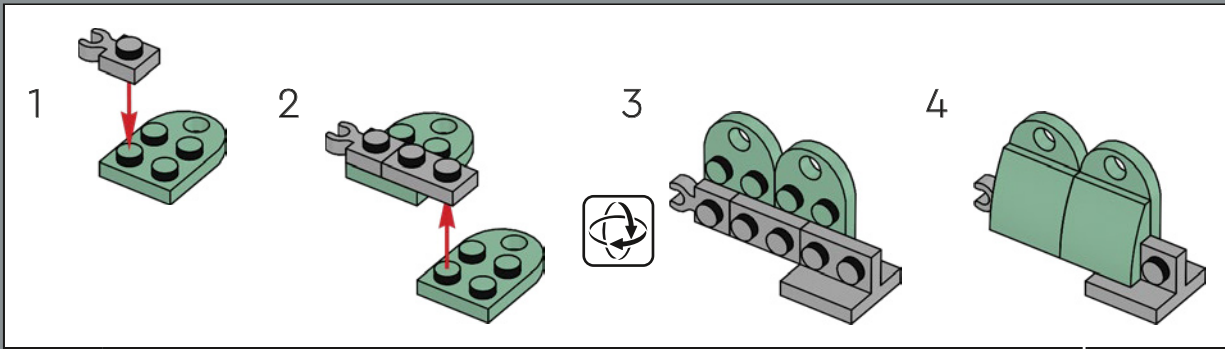

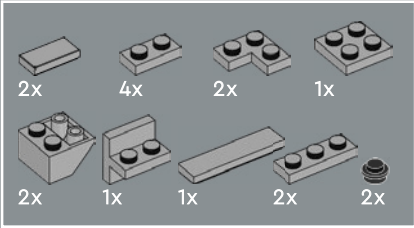
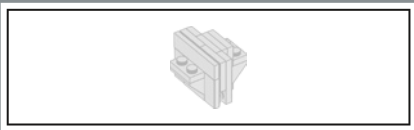

188

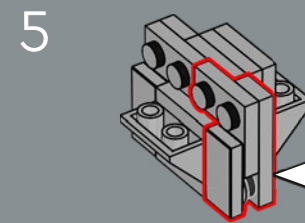
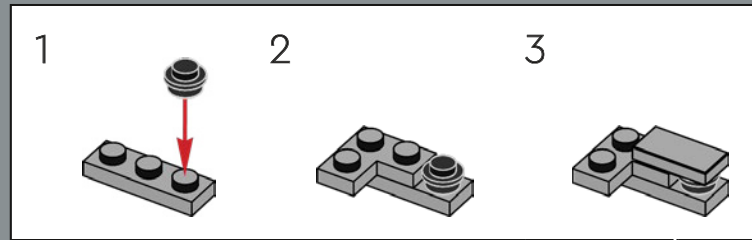
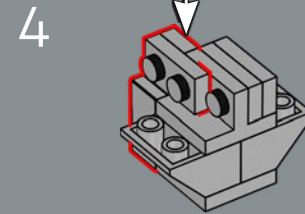
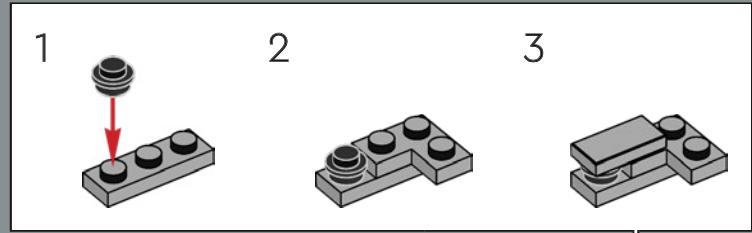
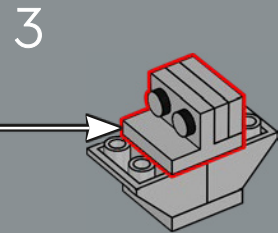
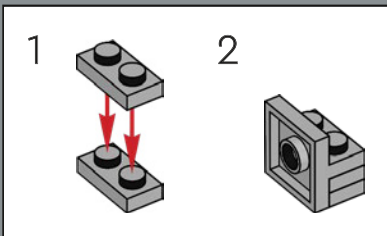
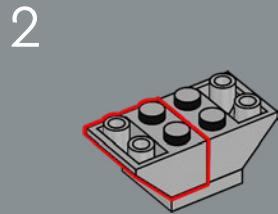
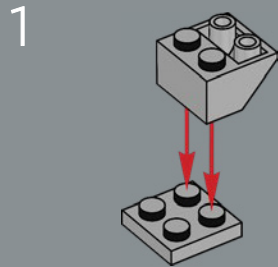

6

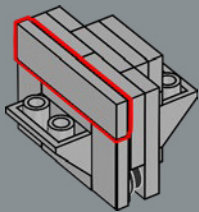

7

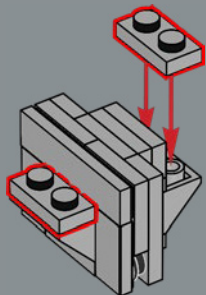

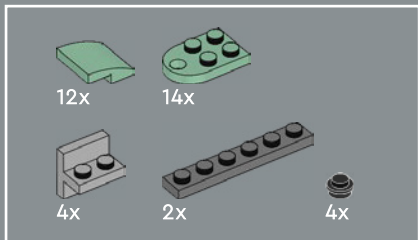

189

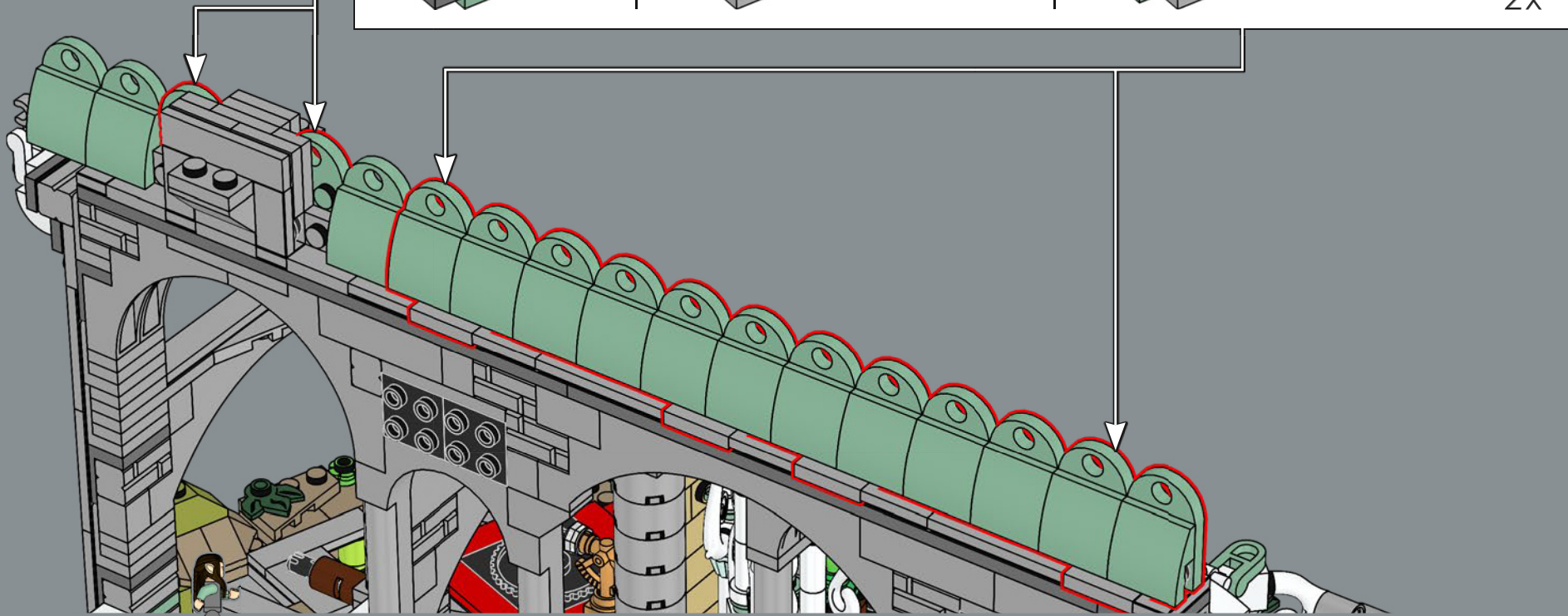
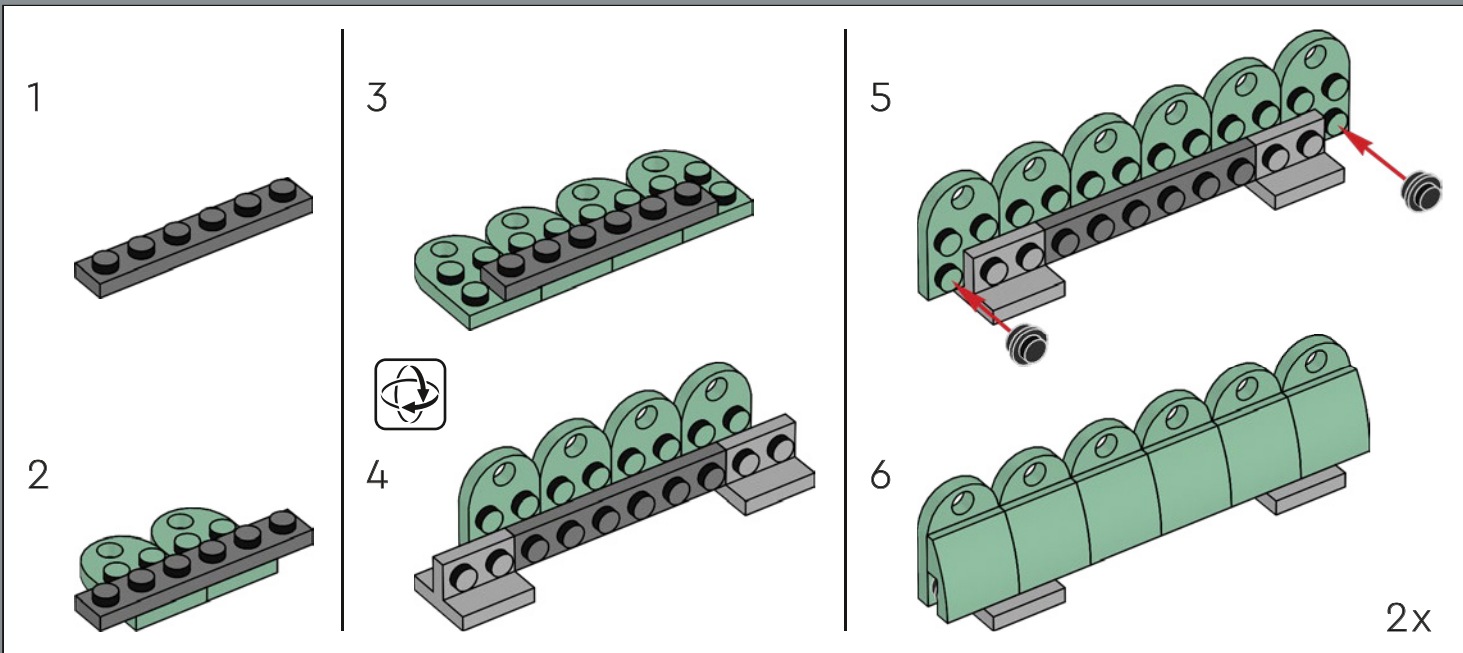
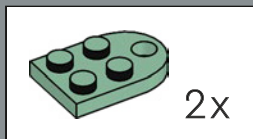



2x

190



2x

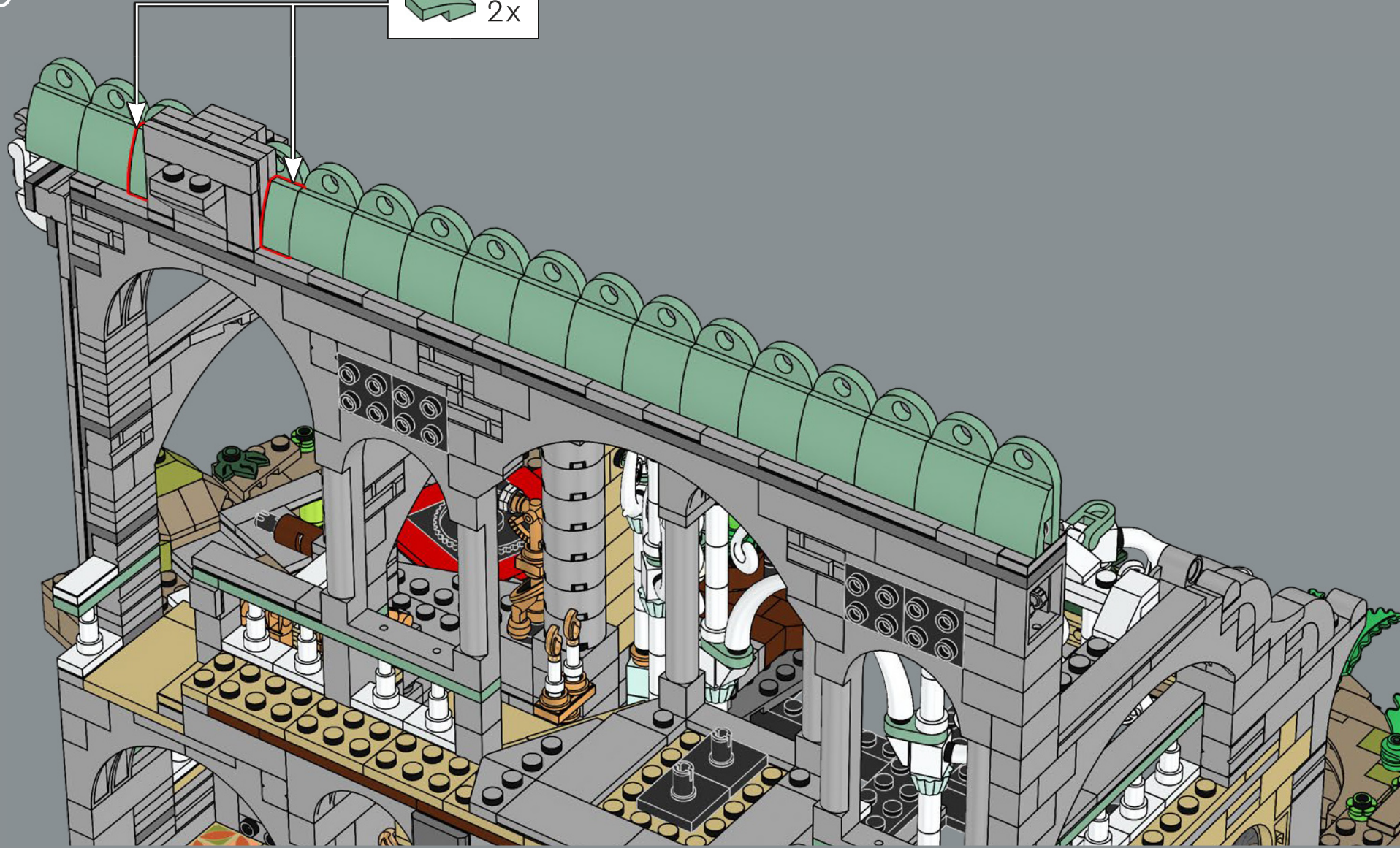

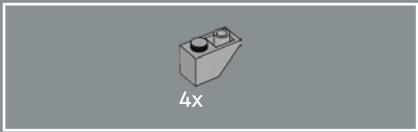

191



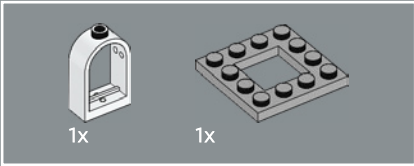
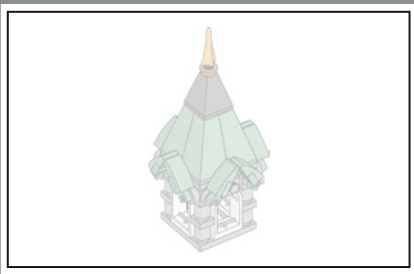

192

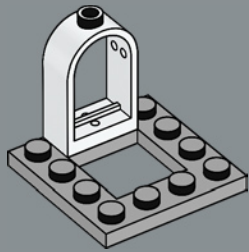

193

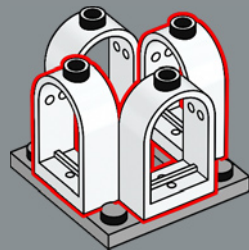

194

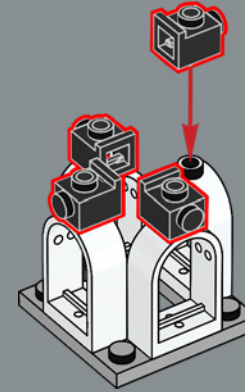

195

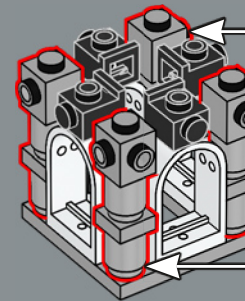
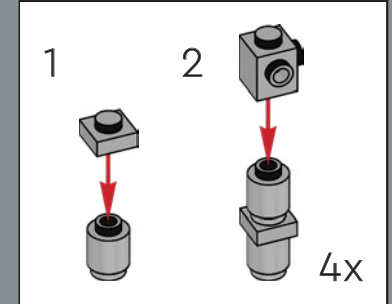

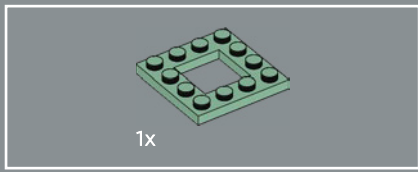

196

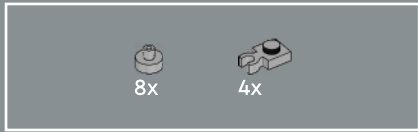
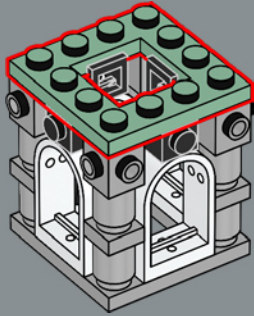

197

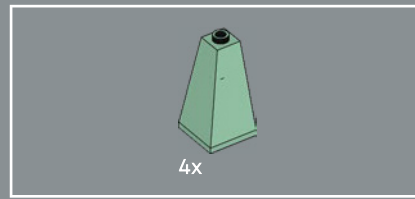
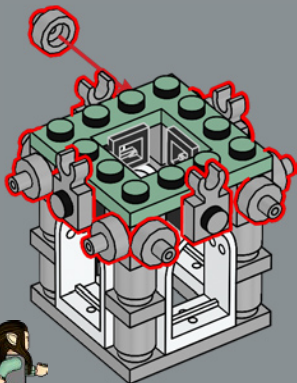

198

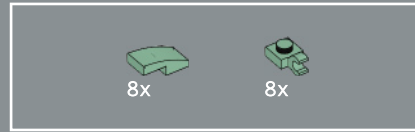
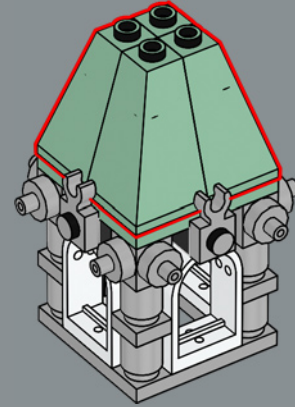

199

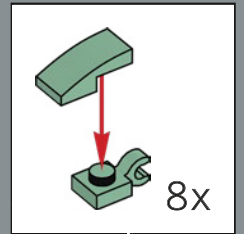
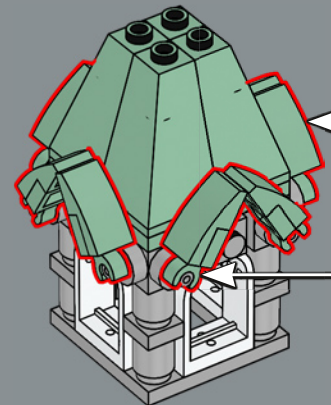



200

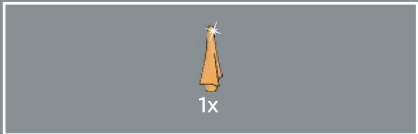
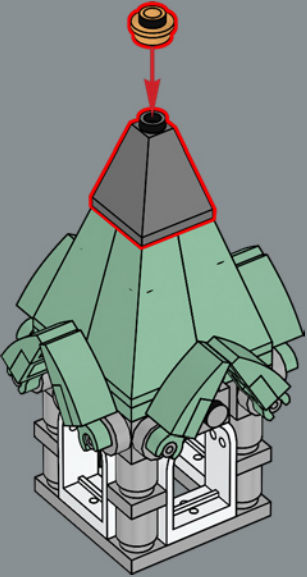

201

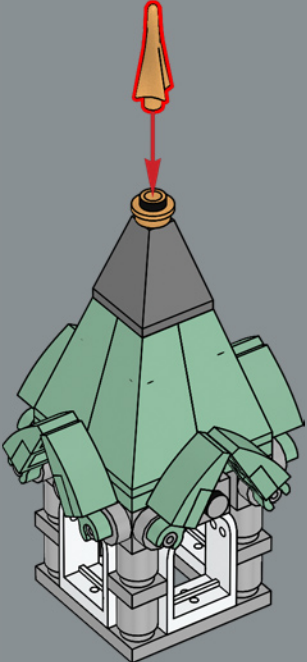

202

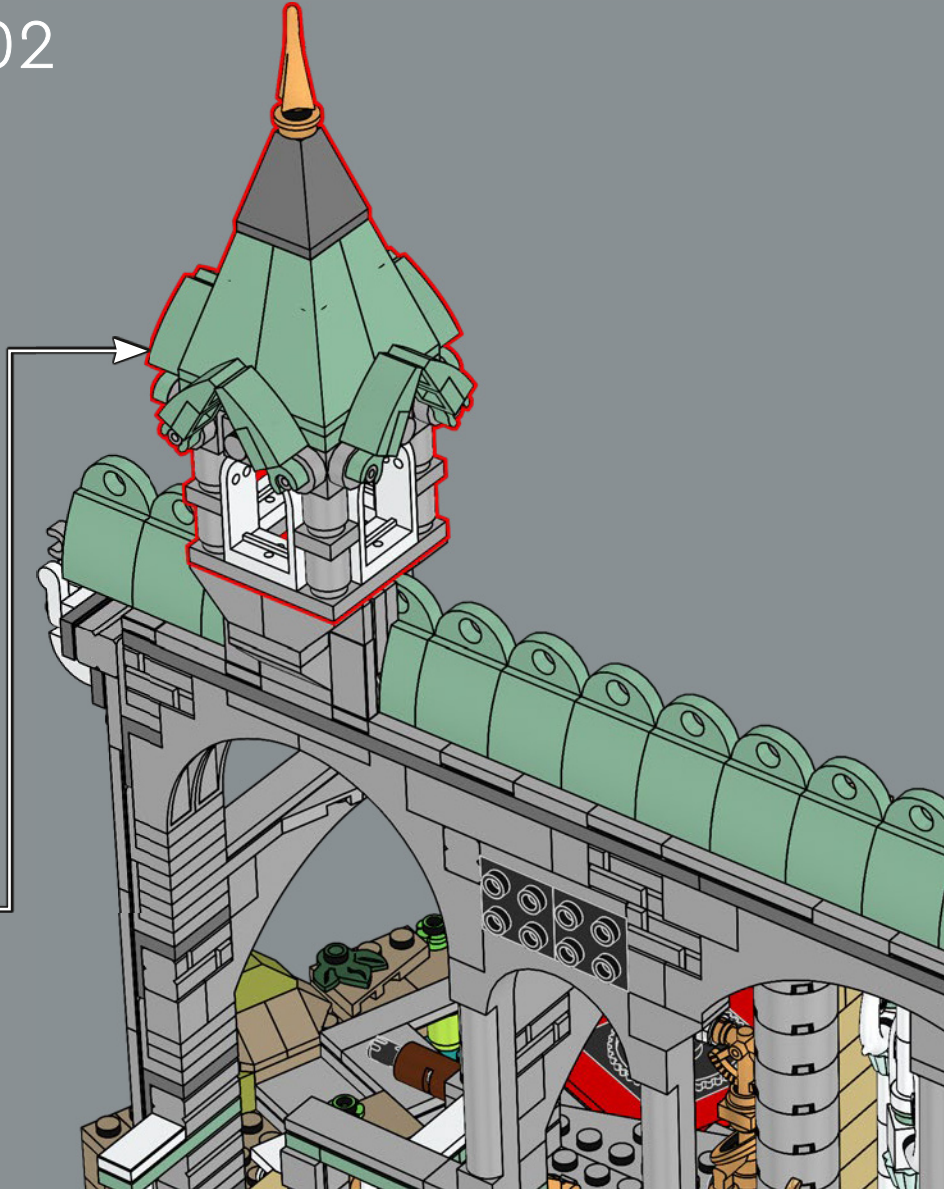

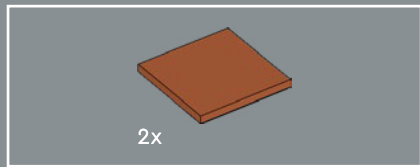

203

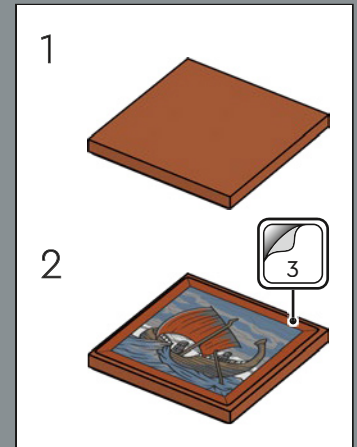
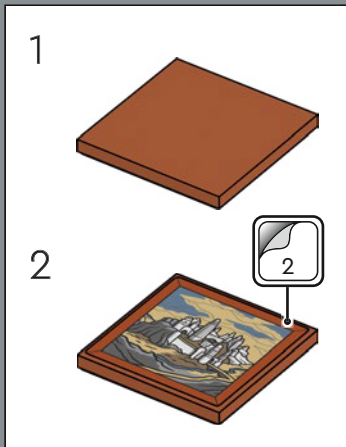

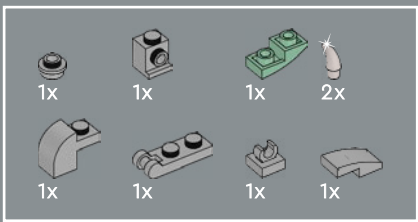

204

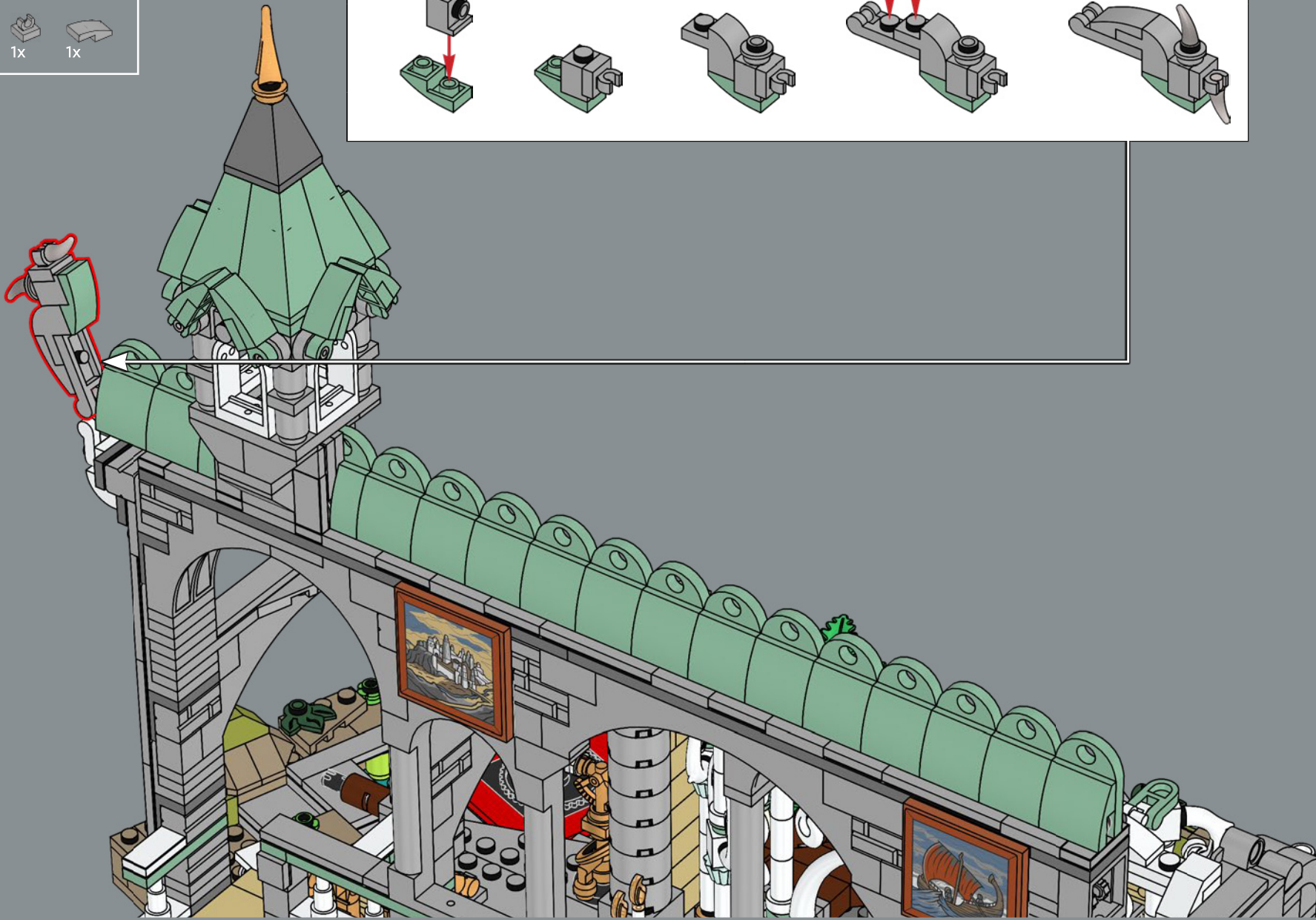
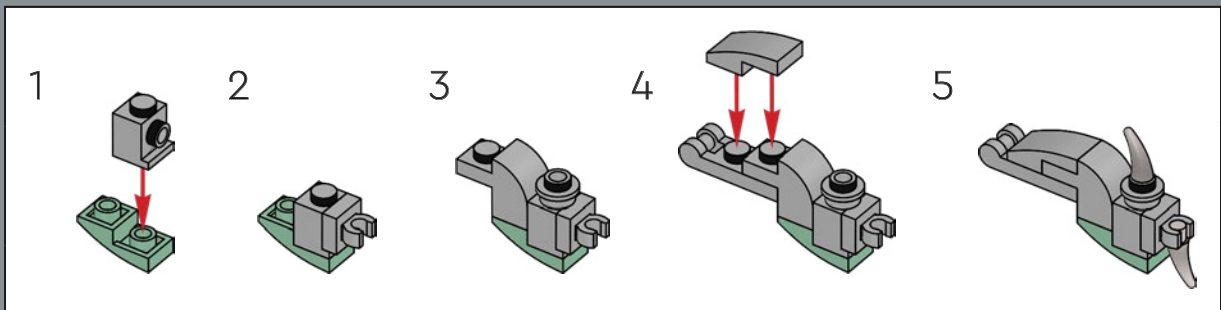

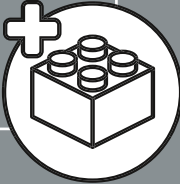
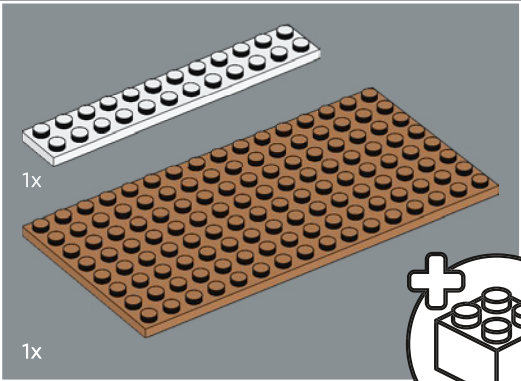
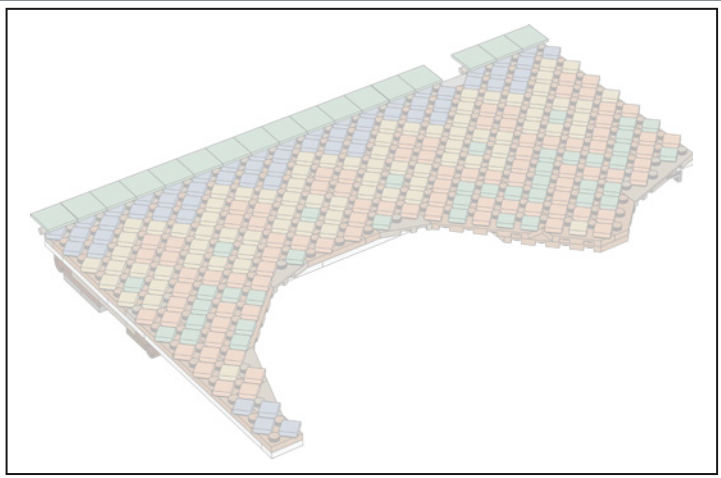
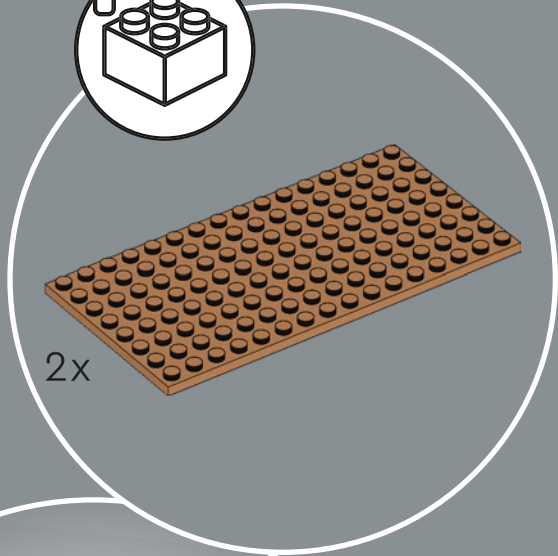
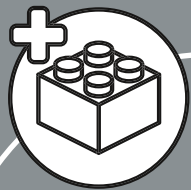

205

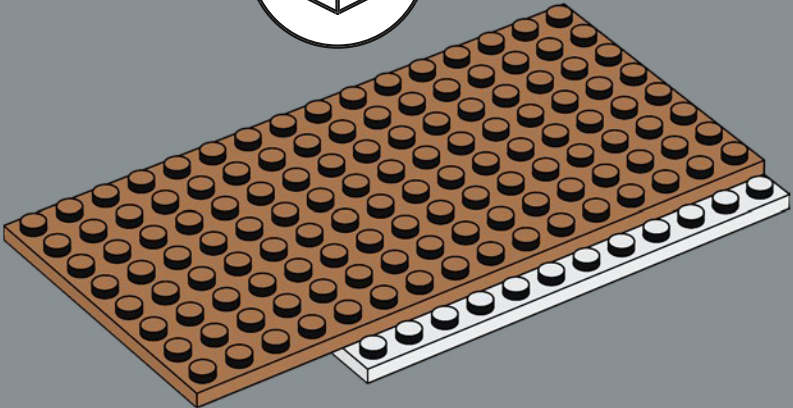

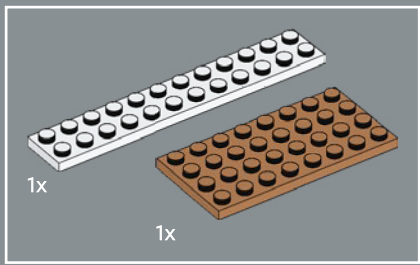

206

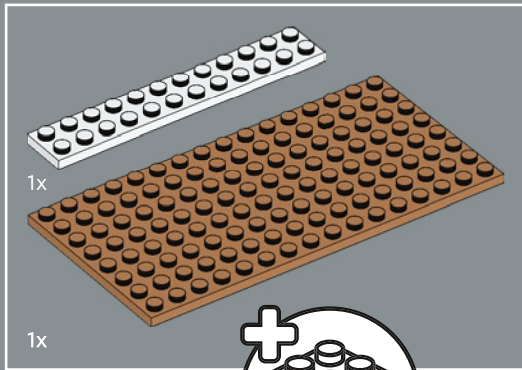
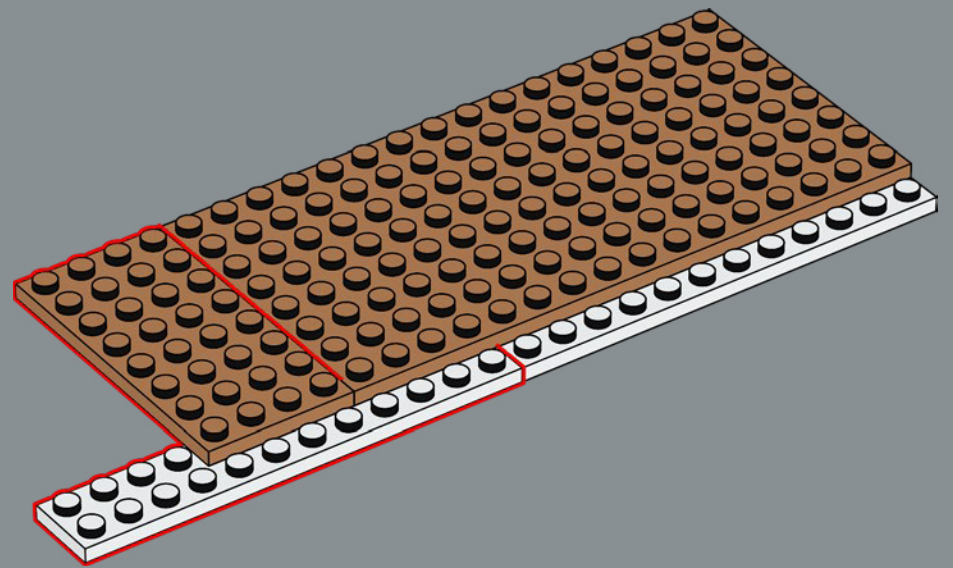

207

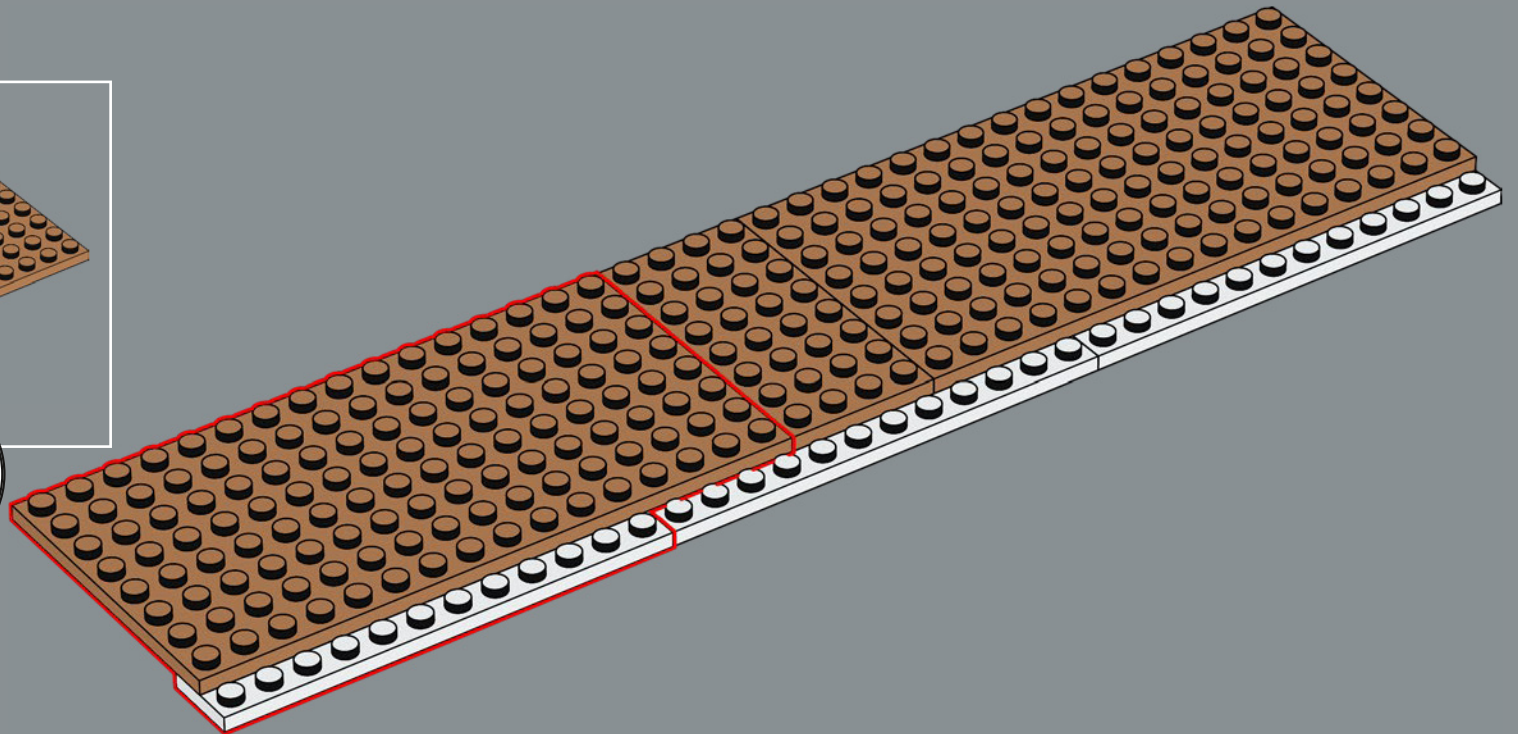
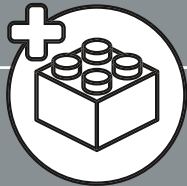

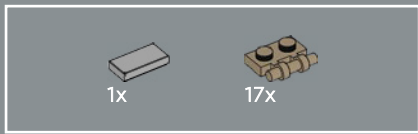

208

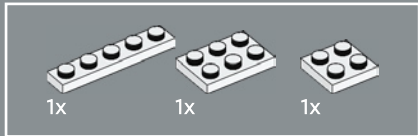
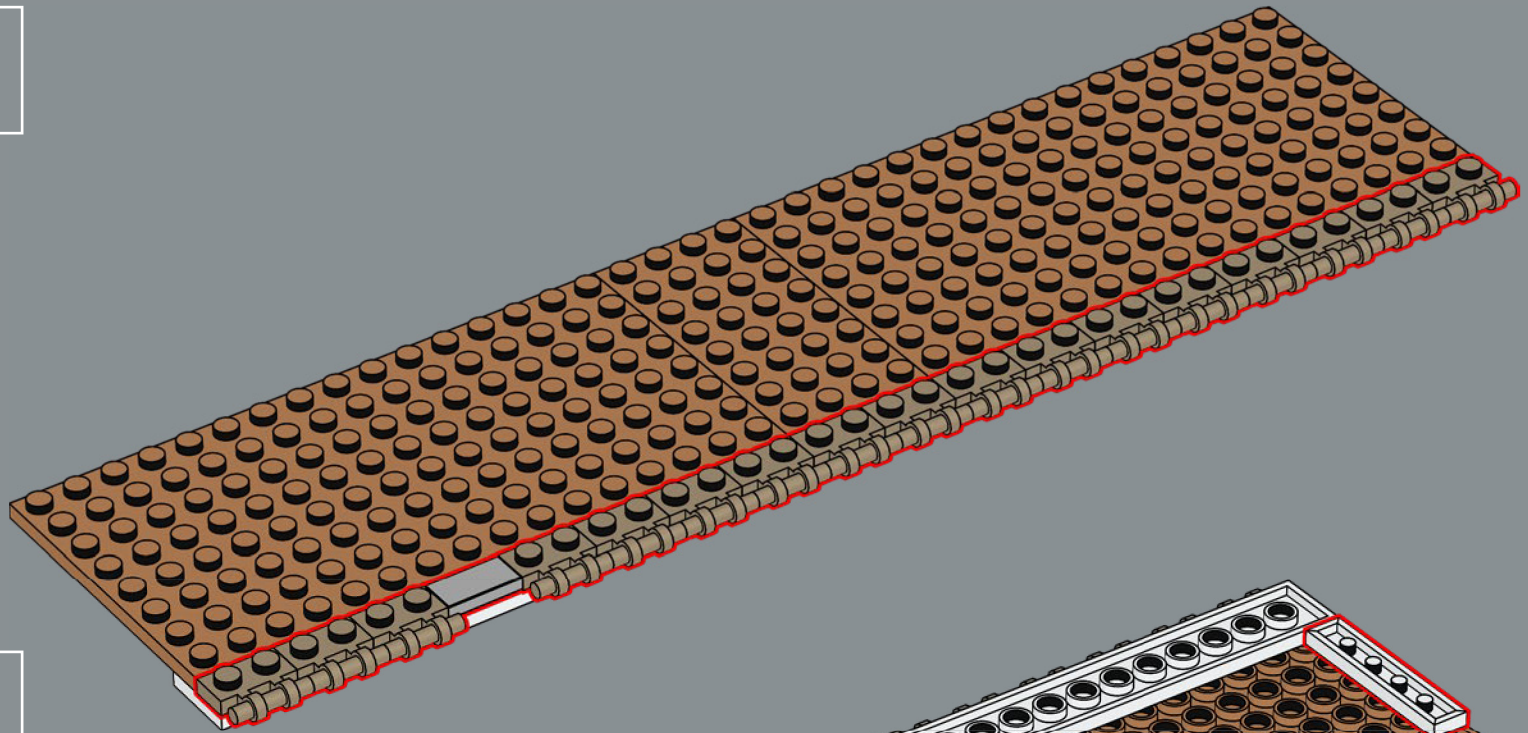

209

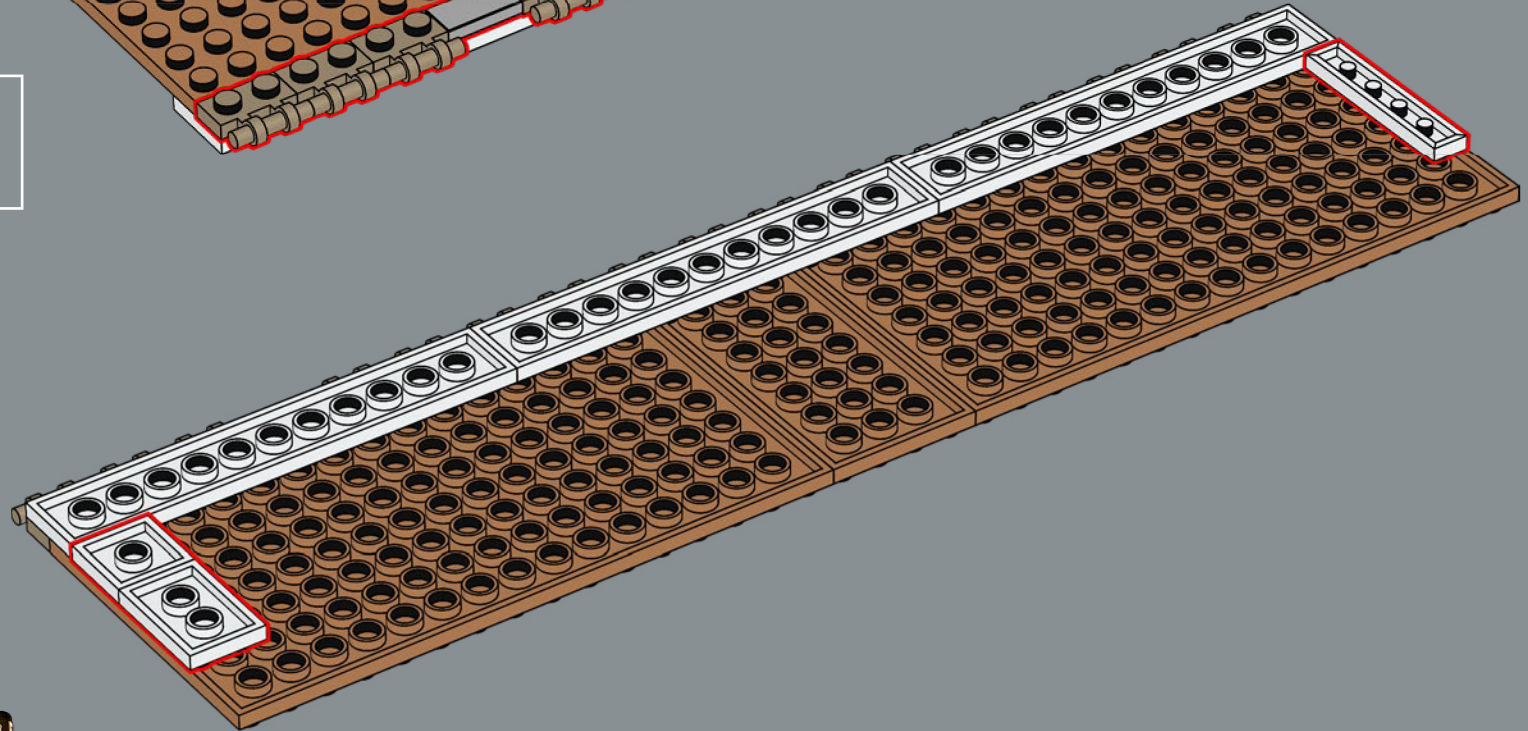

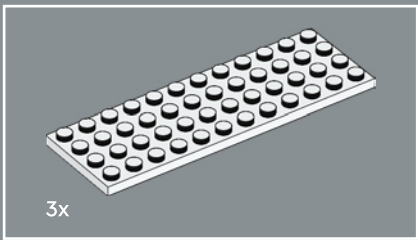

210

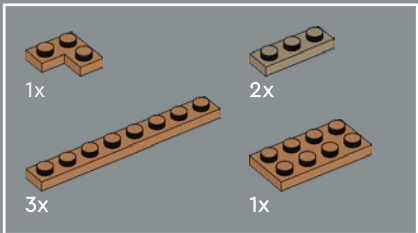
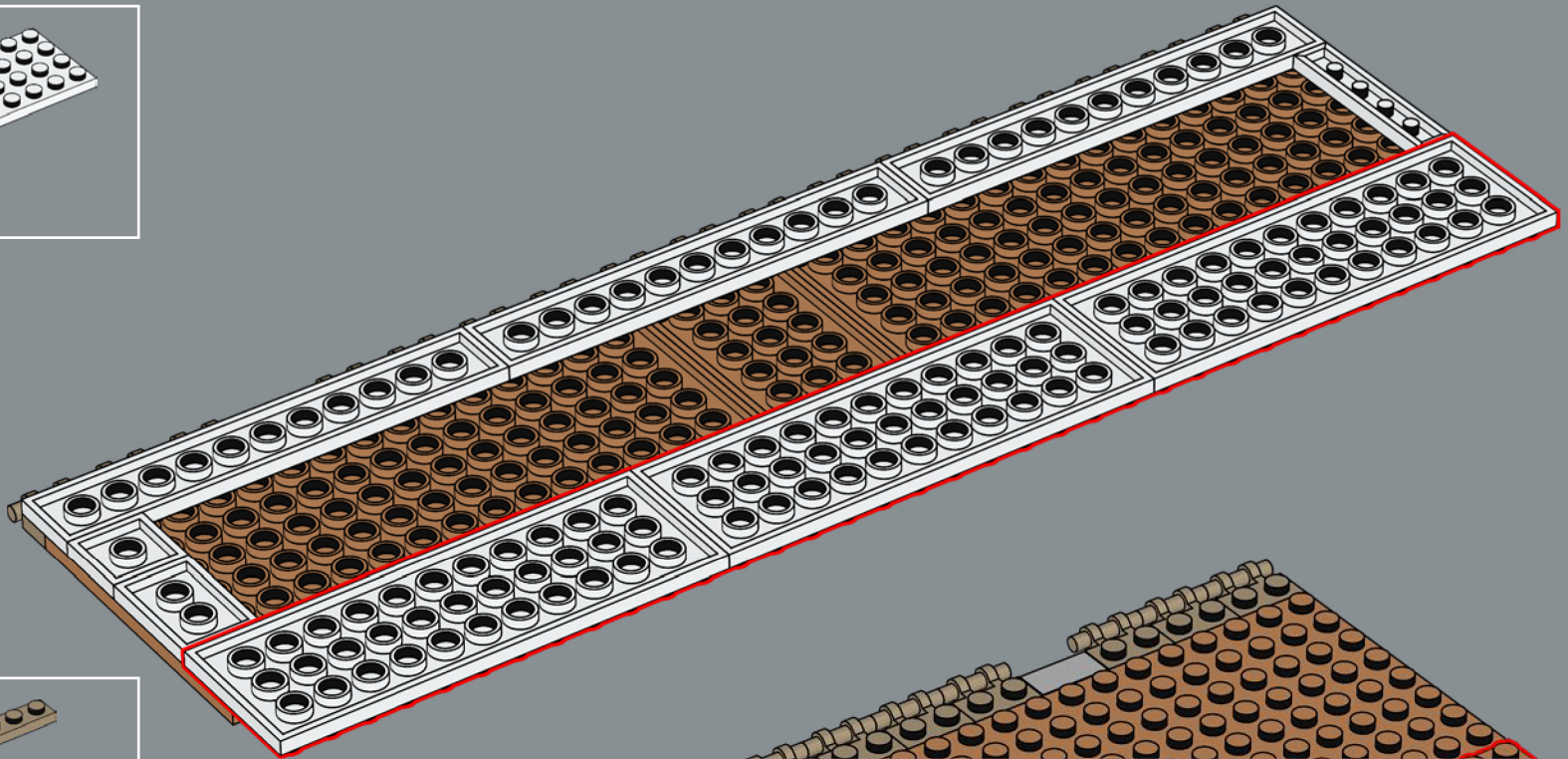

211

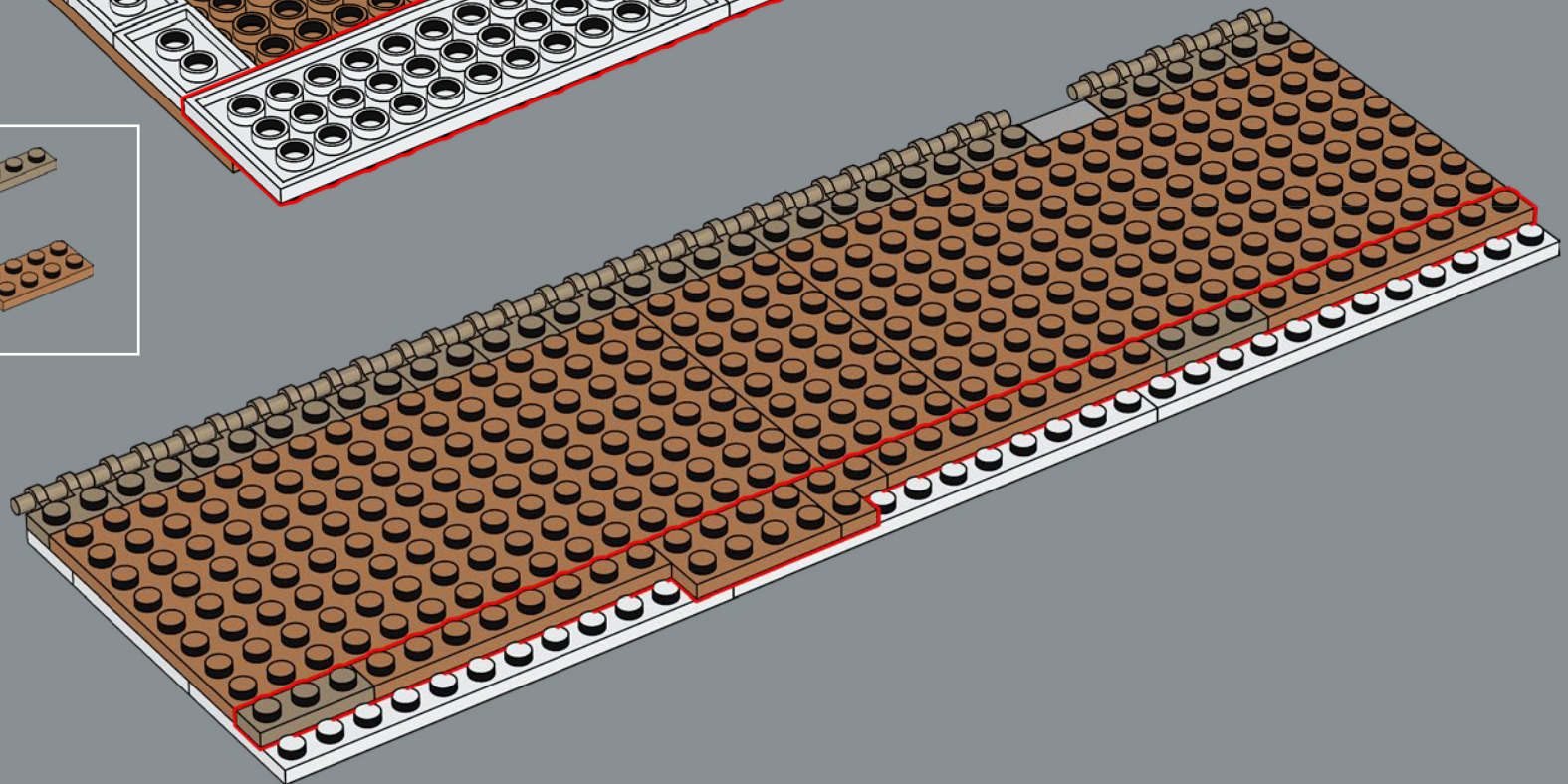

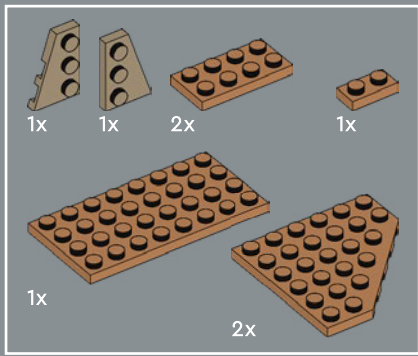

212

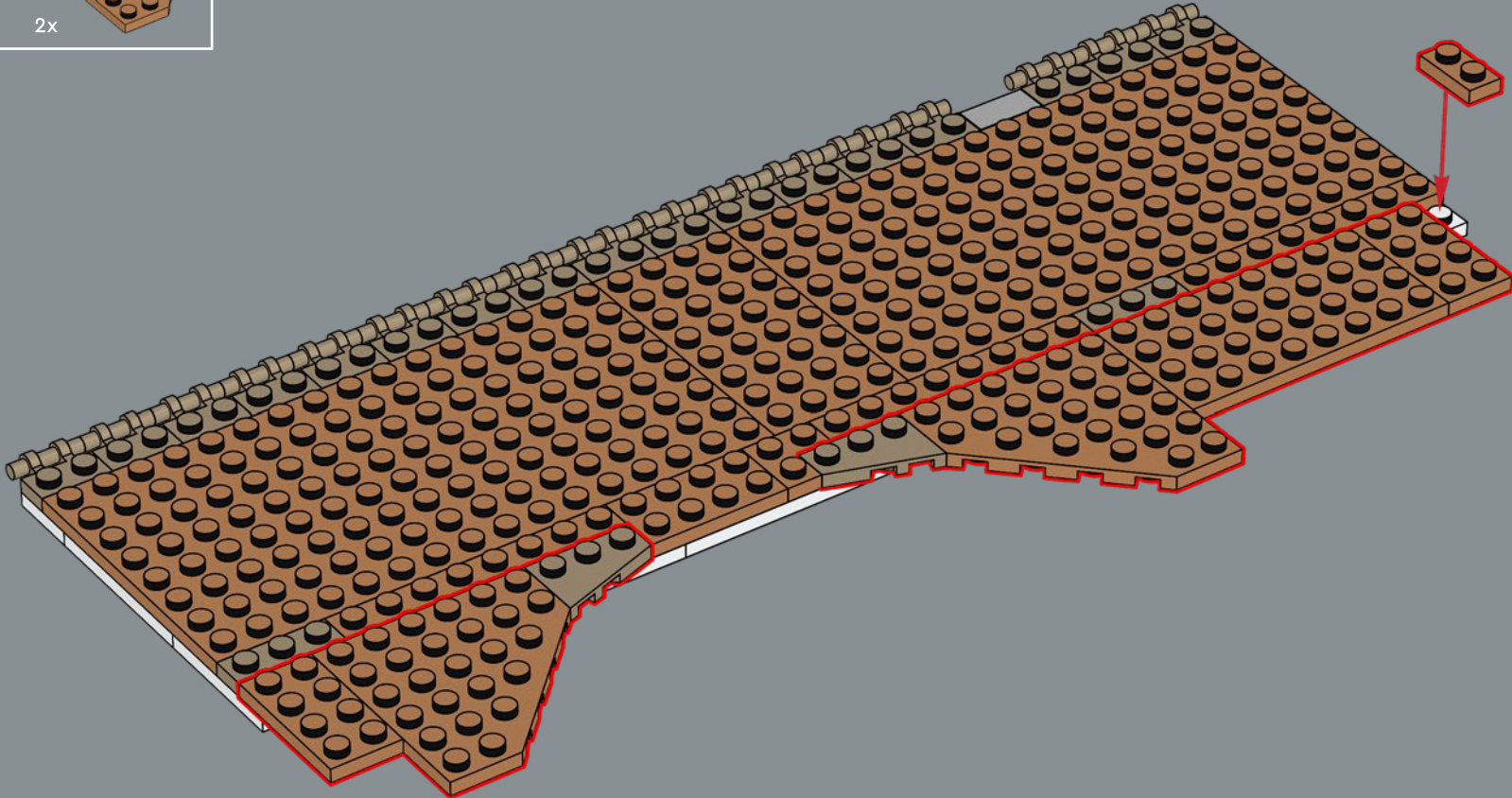

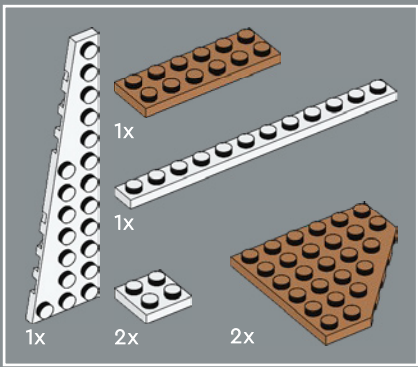

213

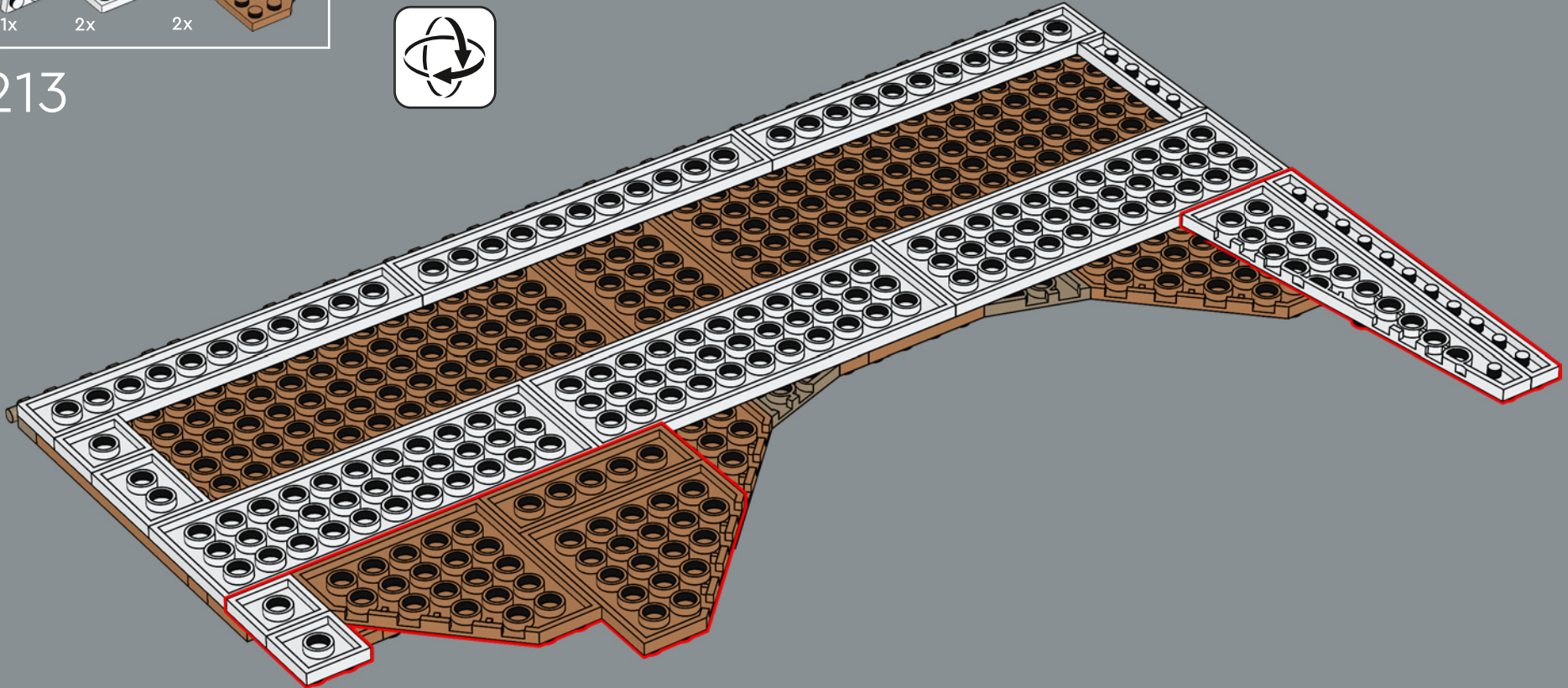

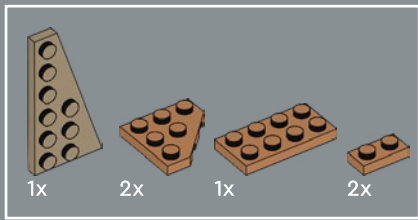

214

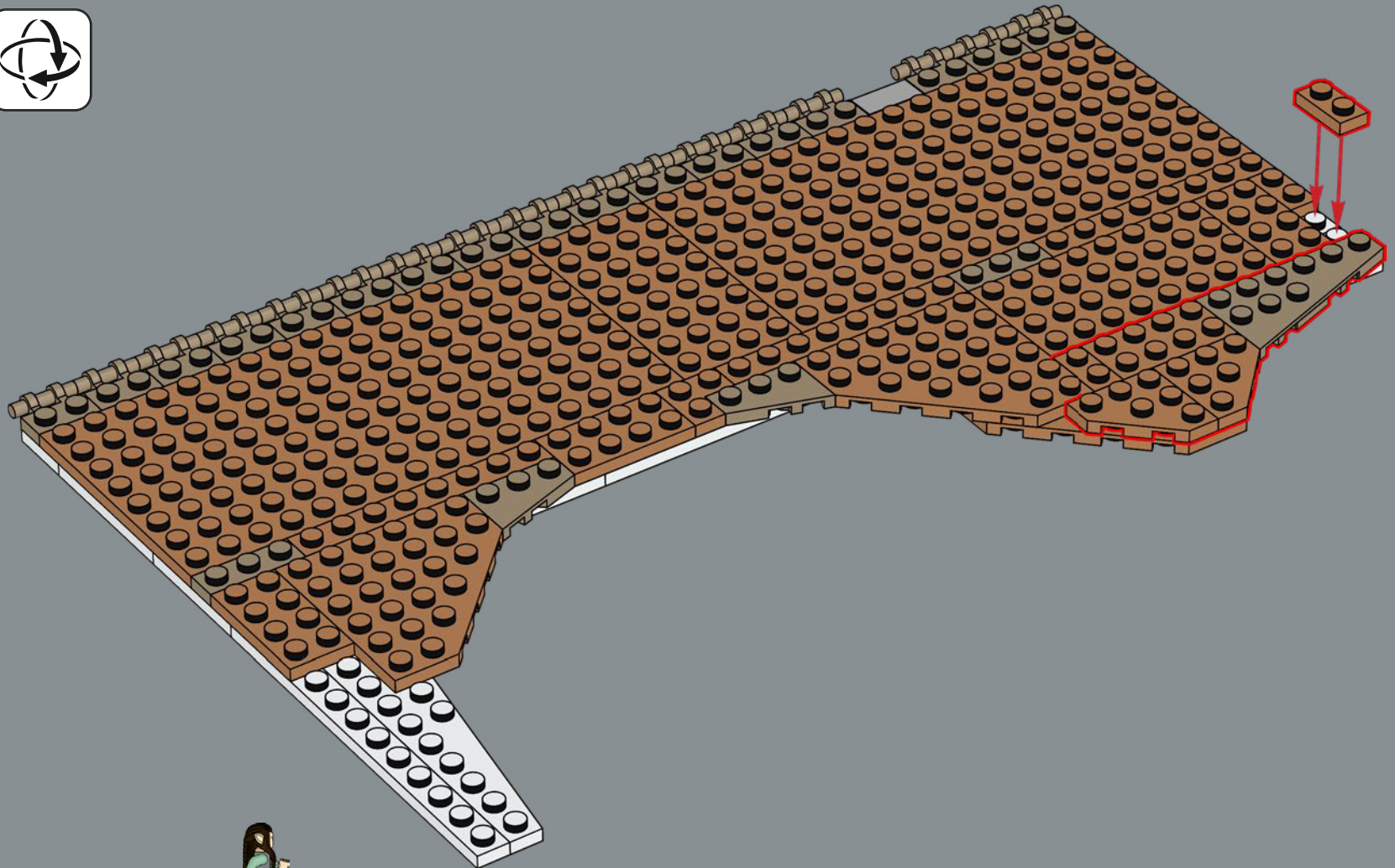

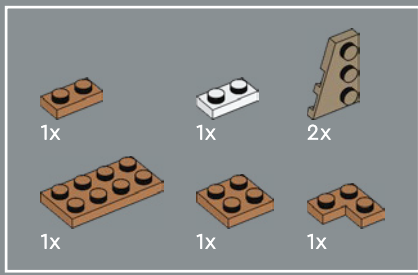

215

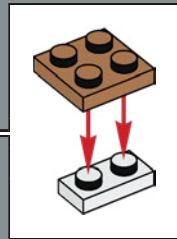
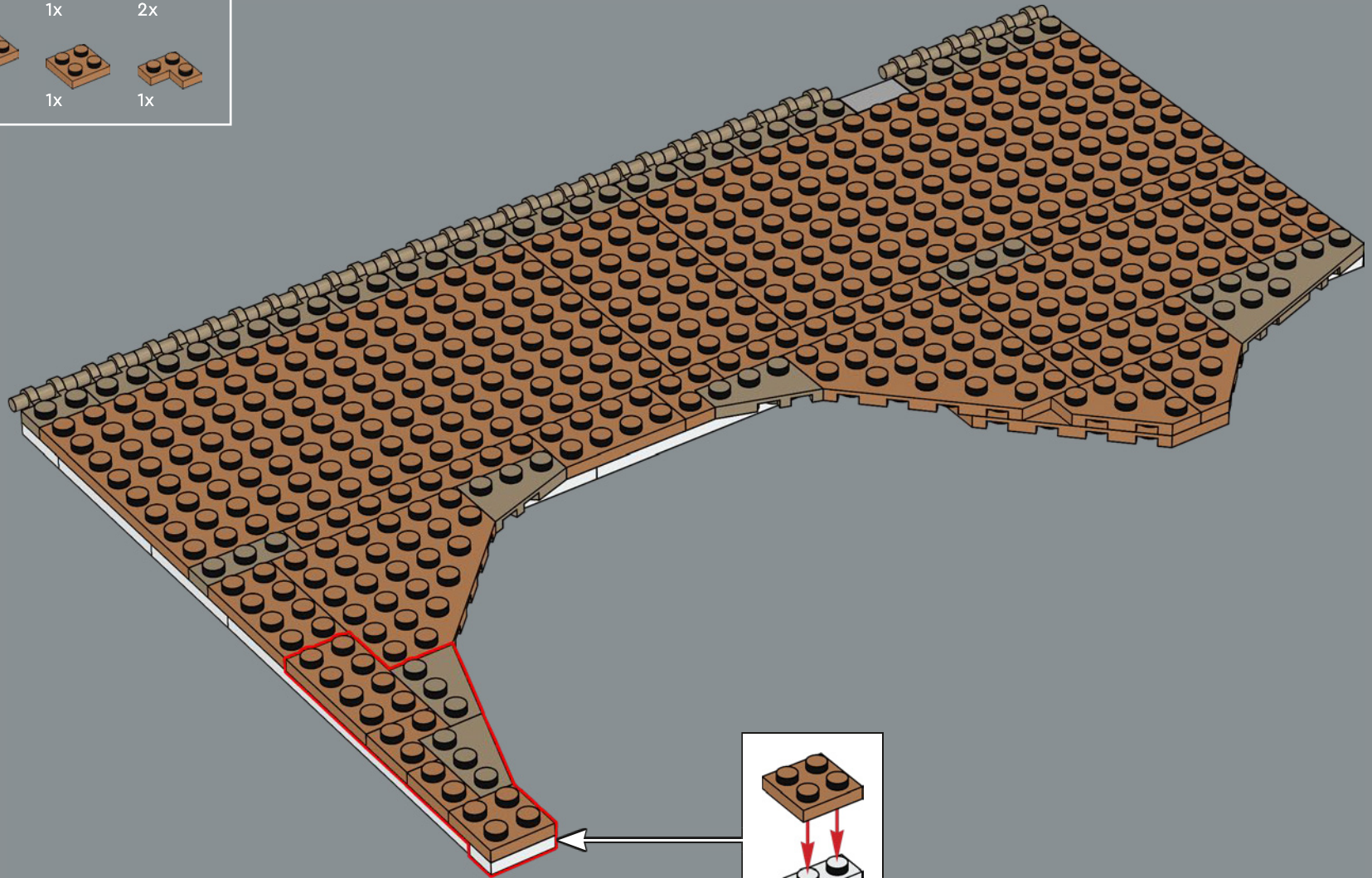

53x

216

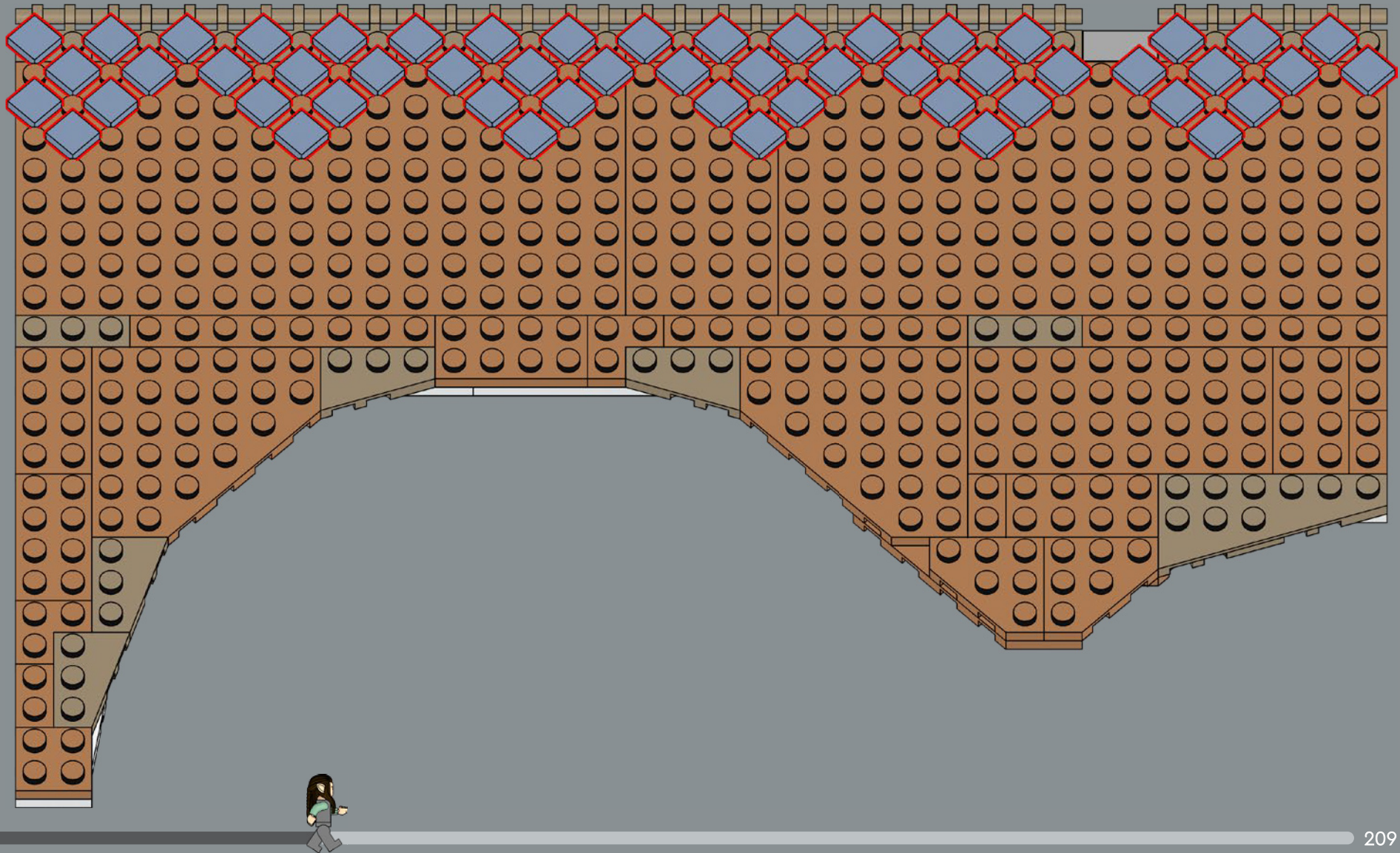

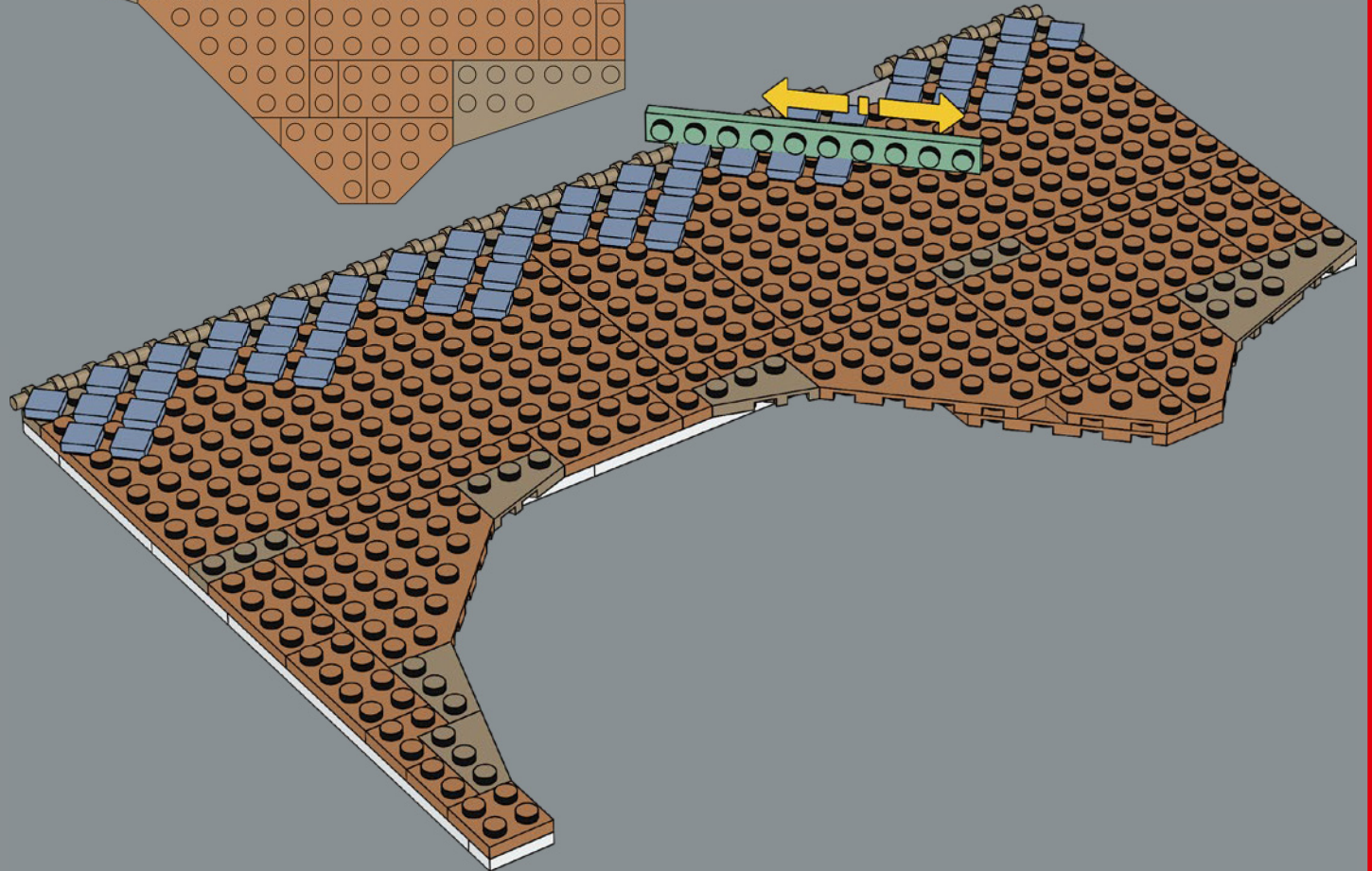
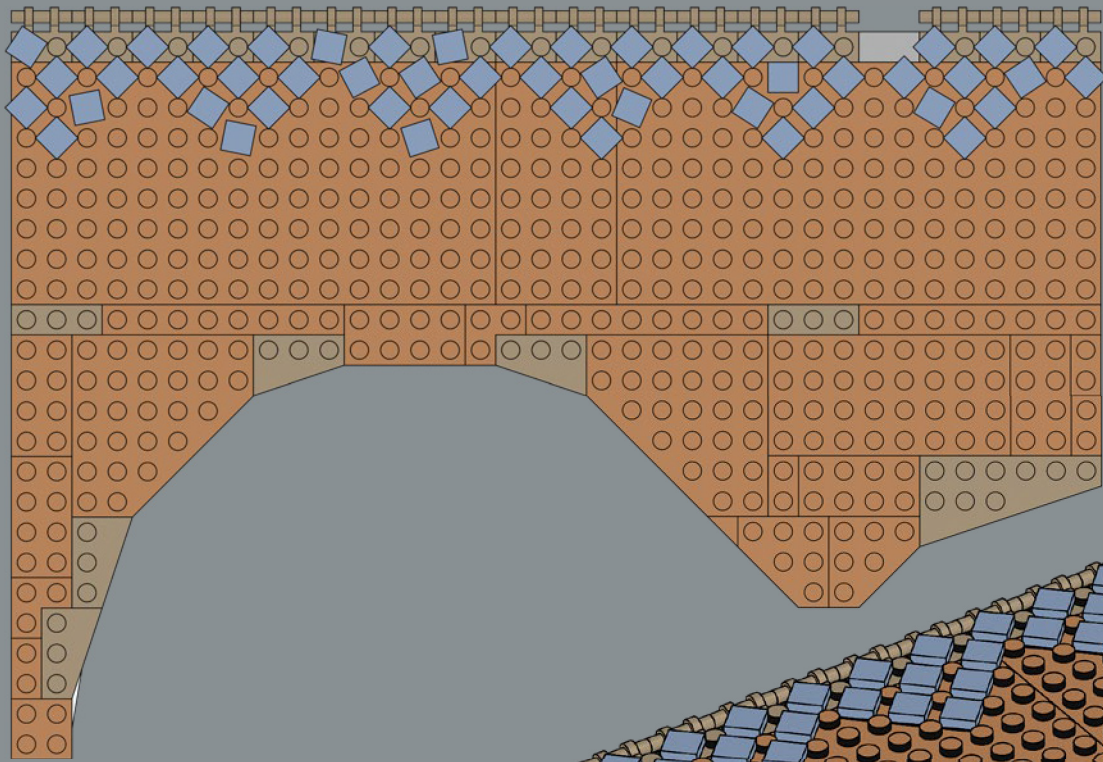

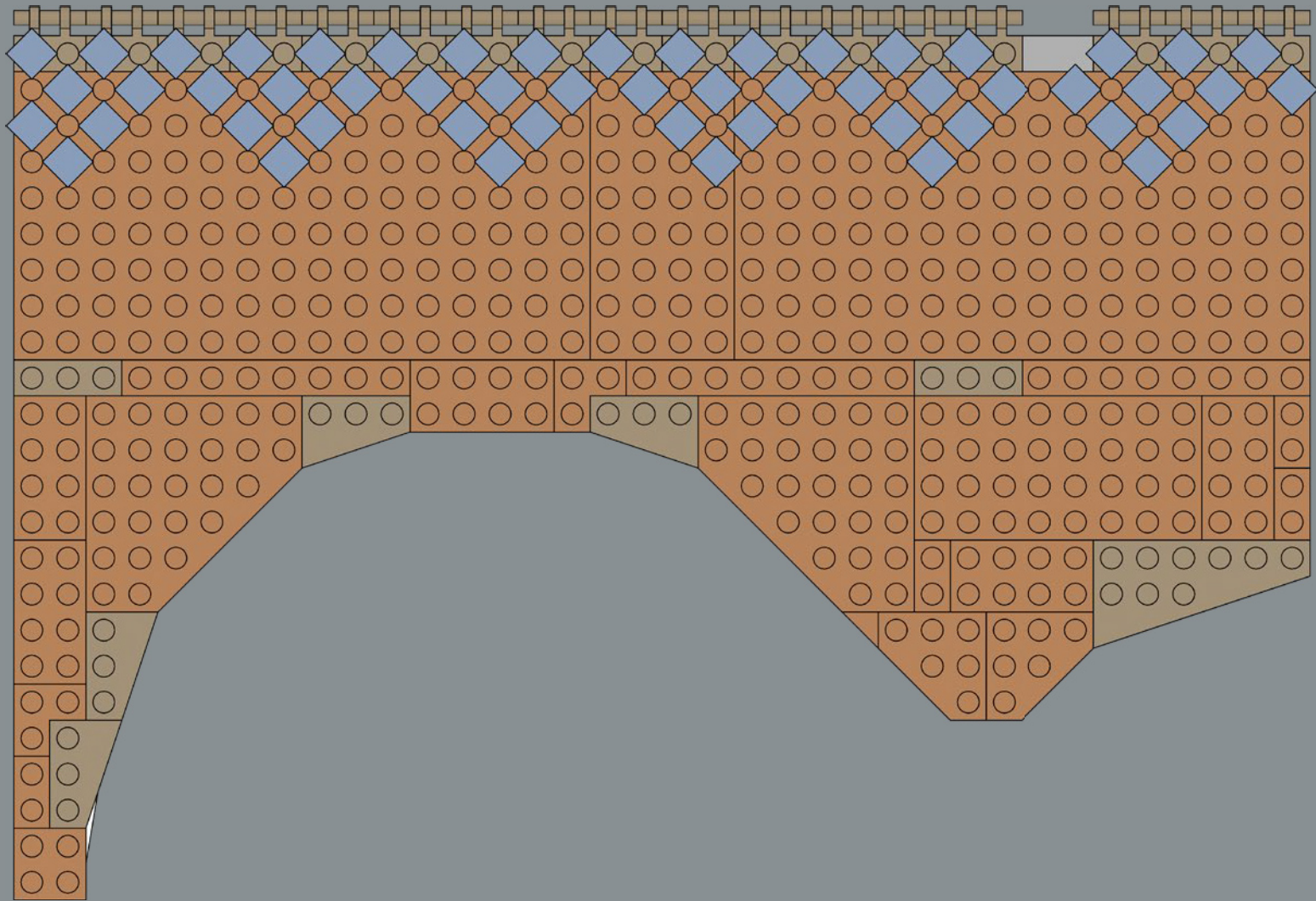

36x 24x

217

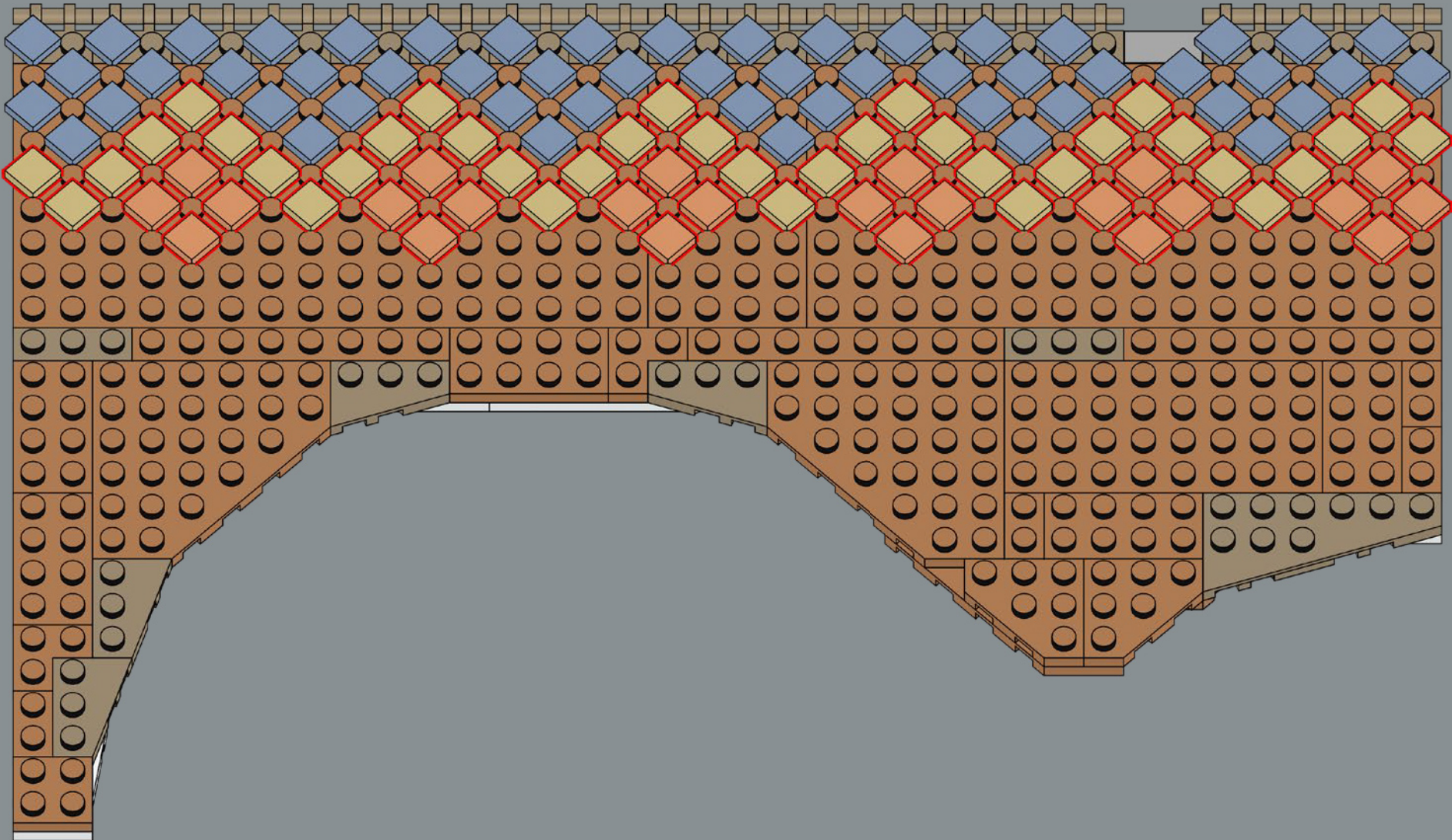

42x 6x 35x

218

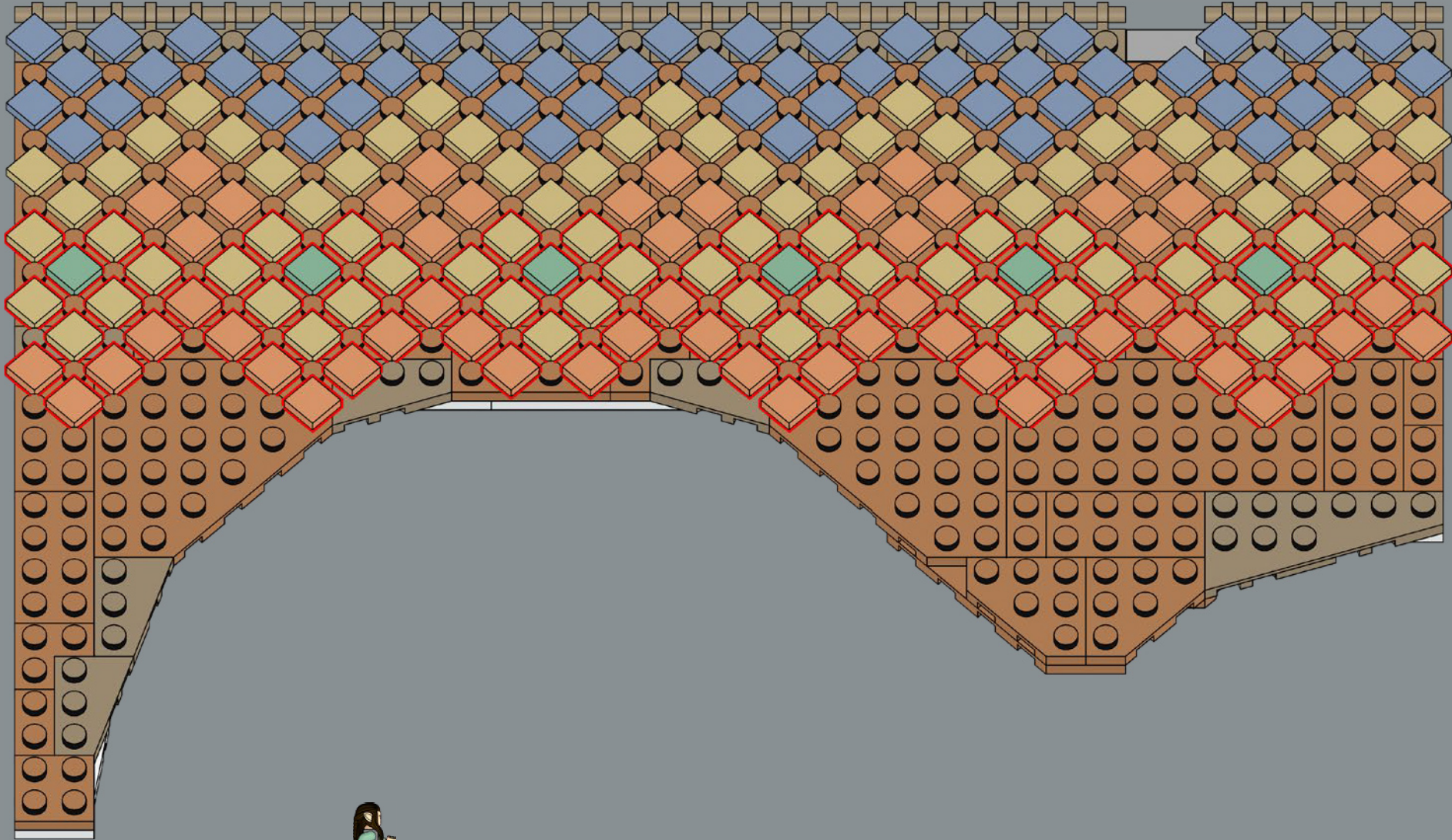

2x 4x 34x 30x

219

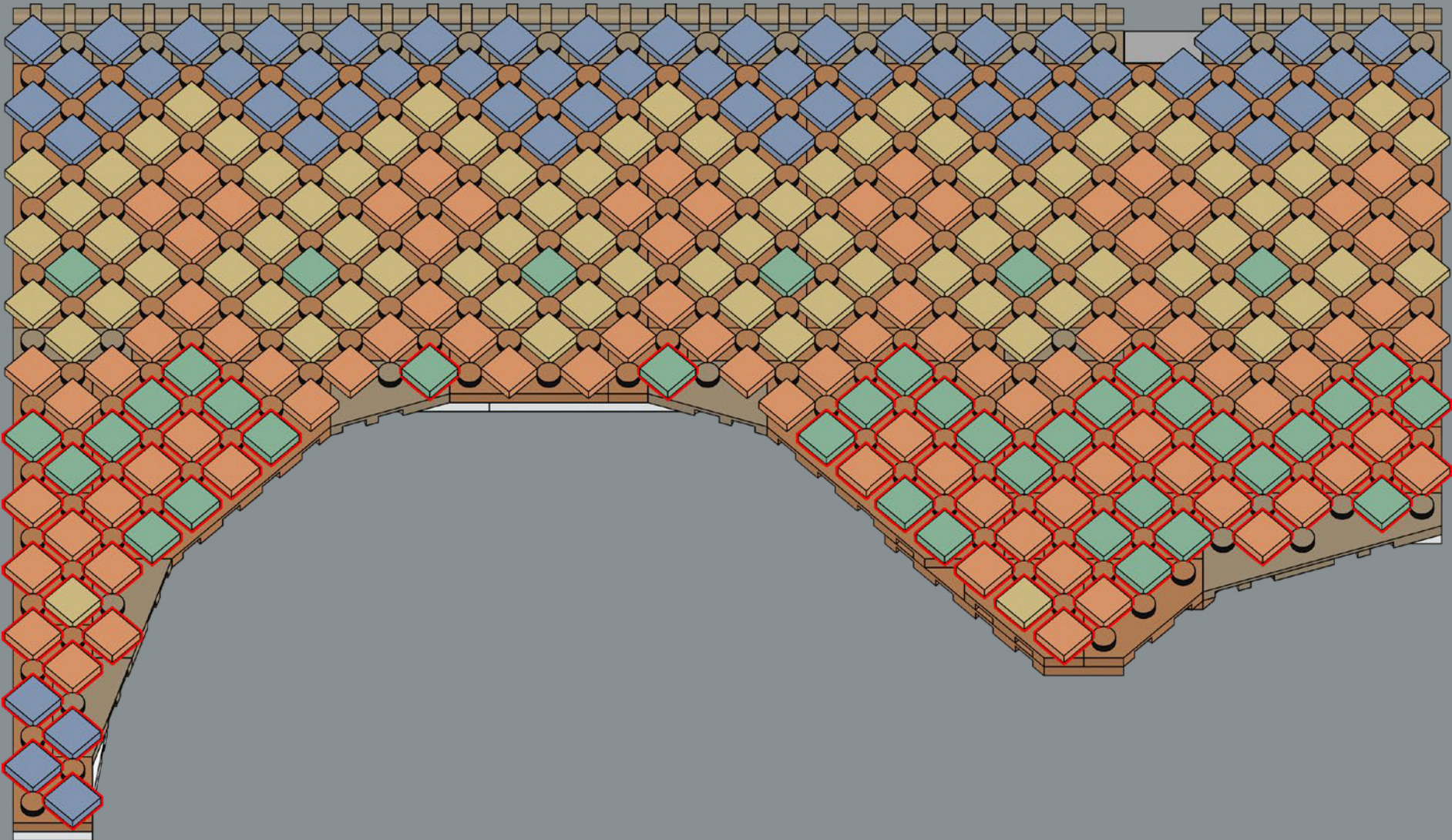



220

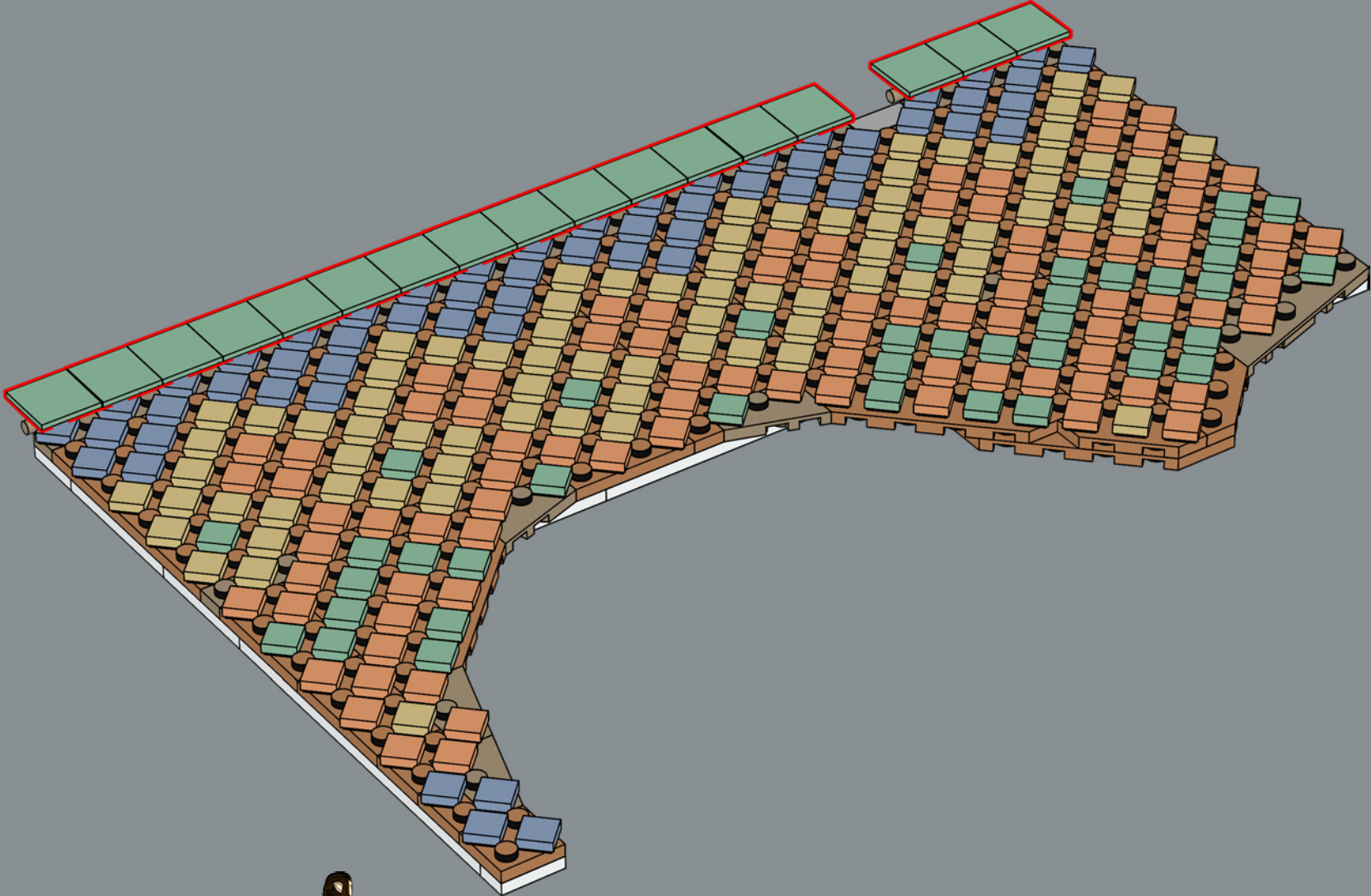

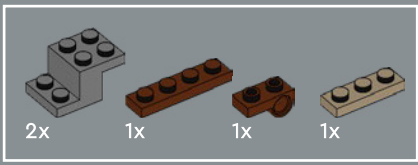

221

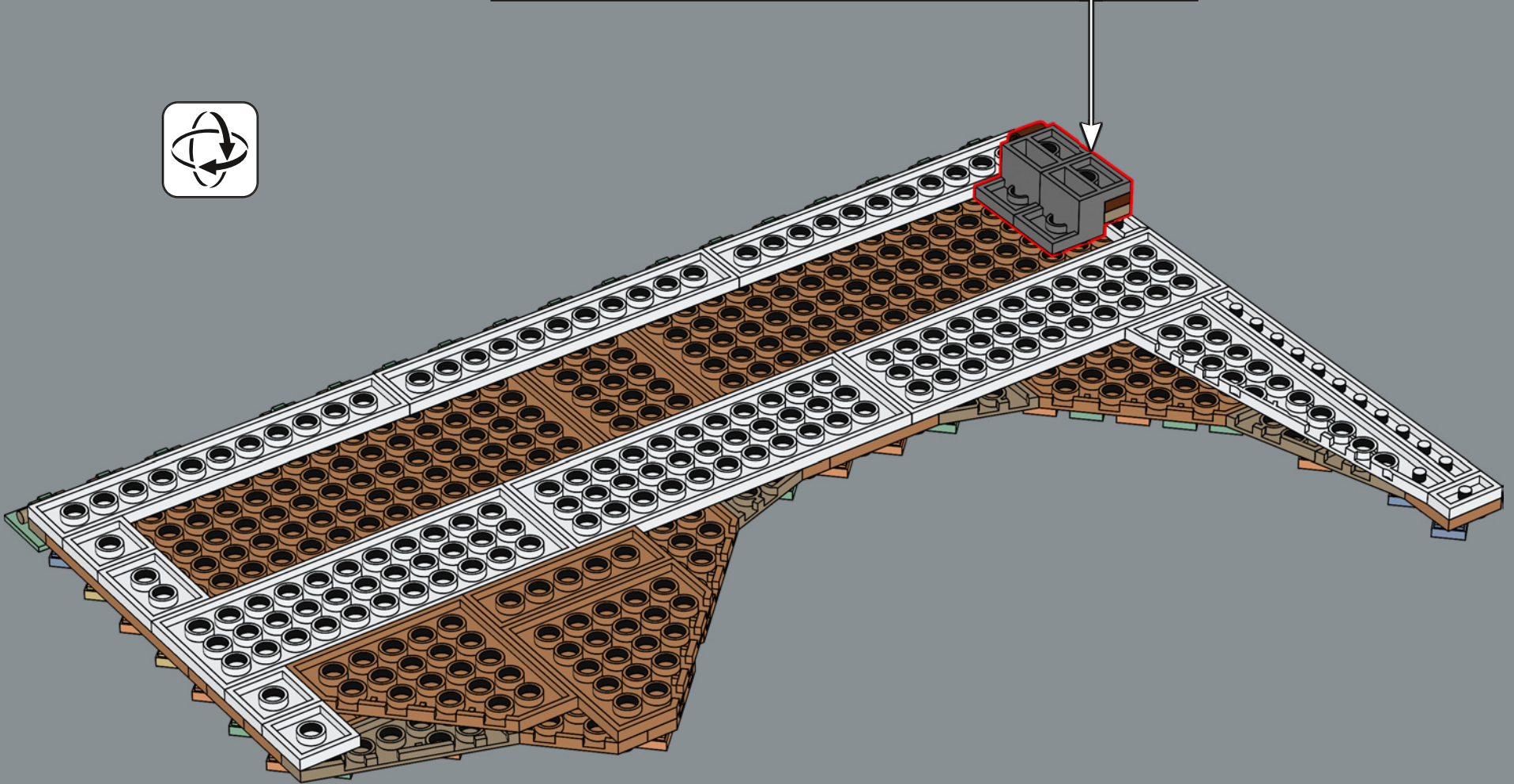
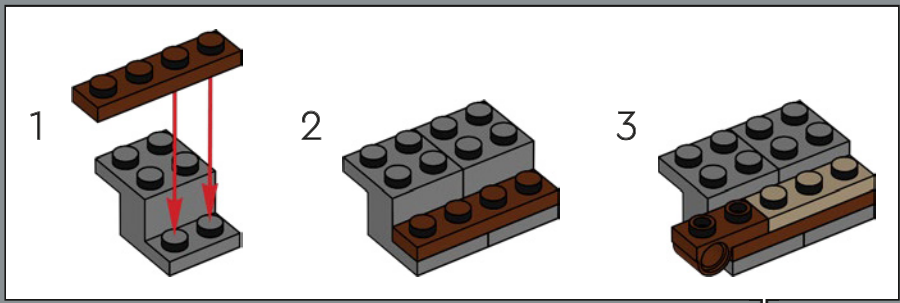

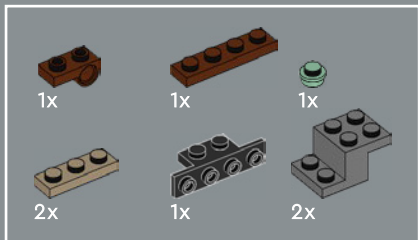

222

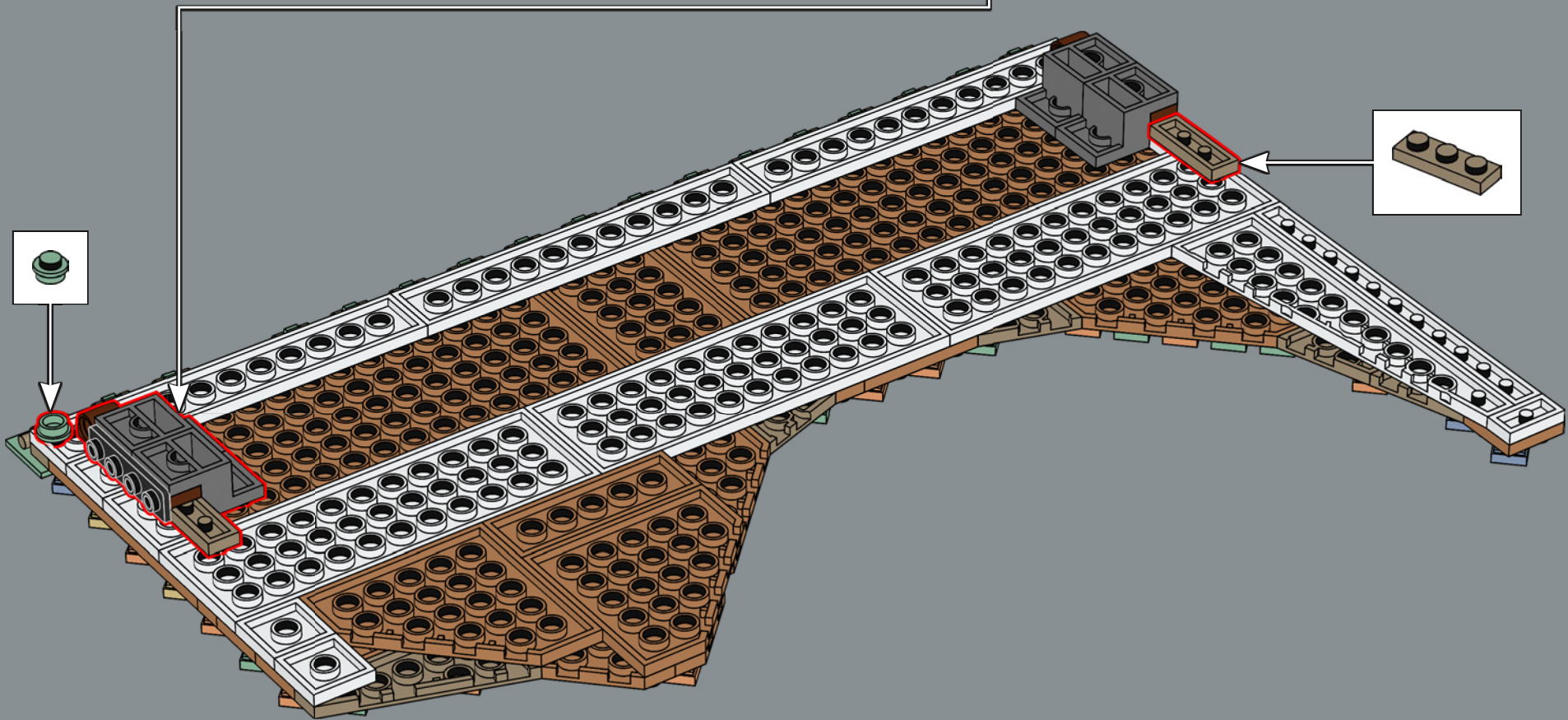
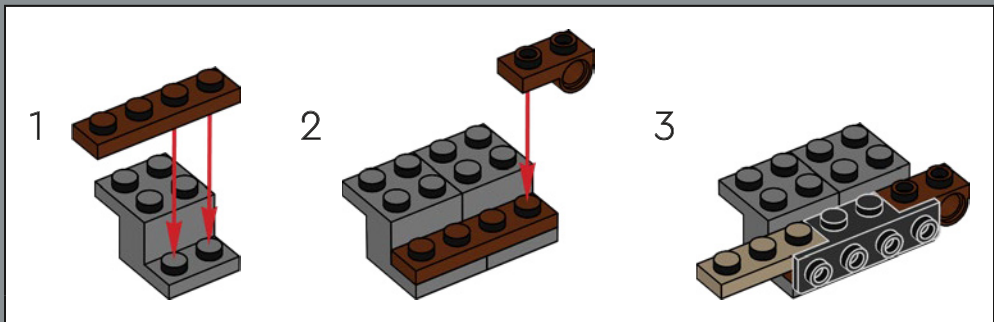

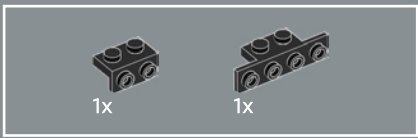

223

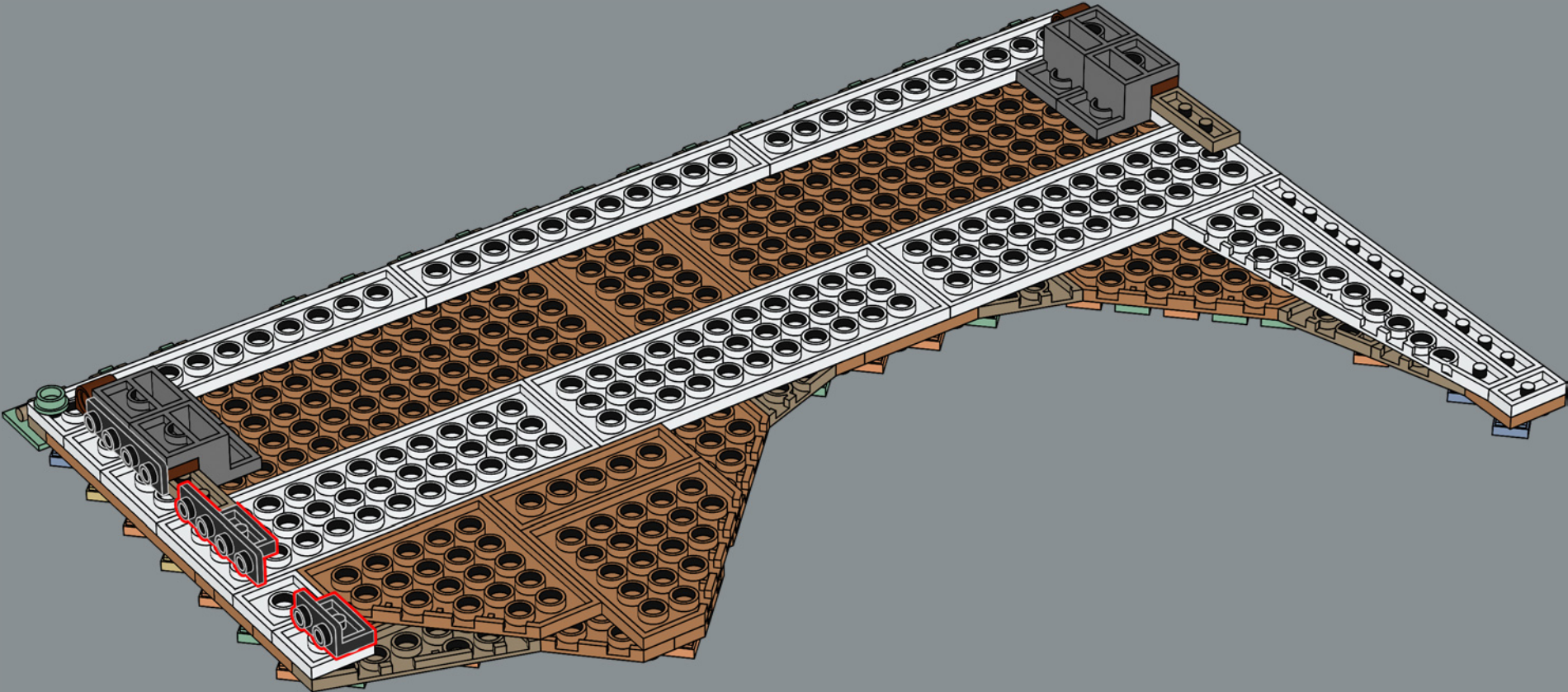

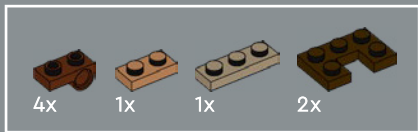

224

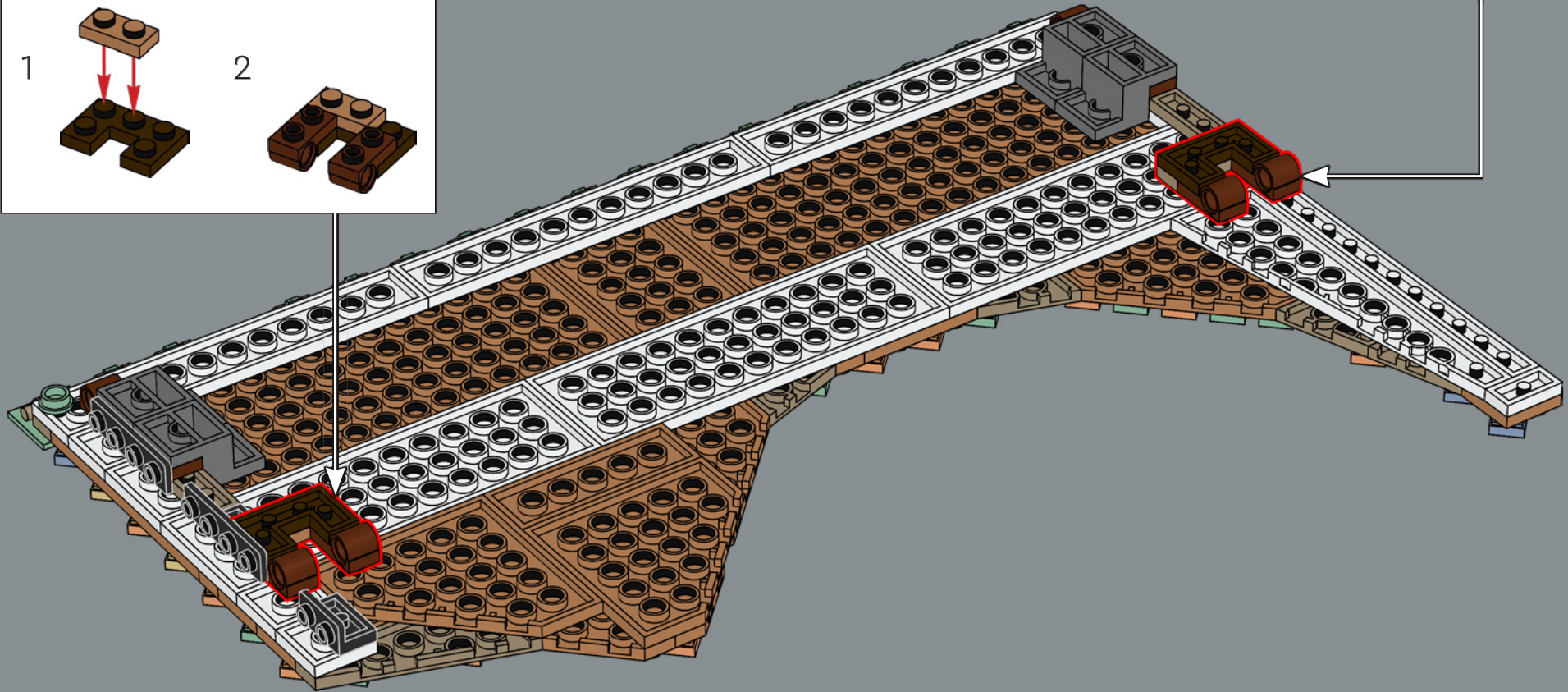
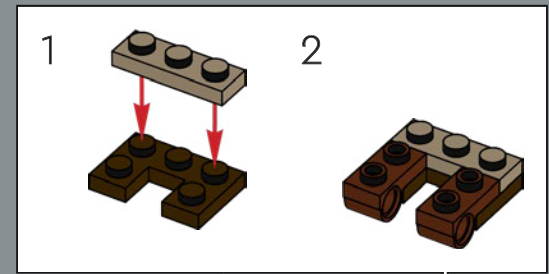
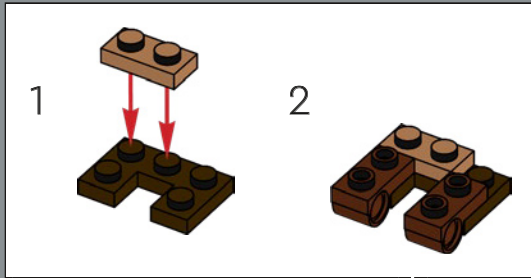

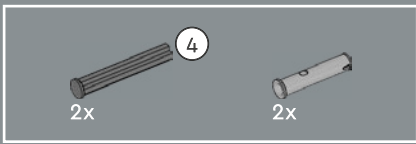

225

Das Dach wird mithilfe eines 3-4-5 Dreiecks befestigt. Sobald das Modell an allen vier Ankerpunkten befestigt ist, verleiht das Dreieck der Konstruktion die nötige Stabilität.



226

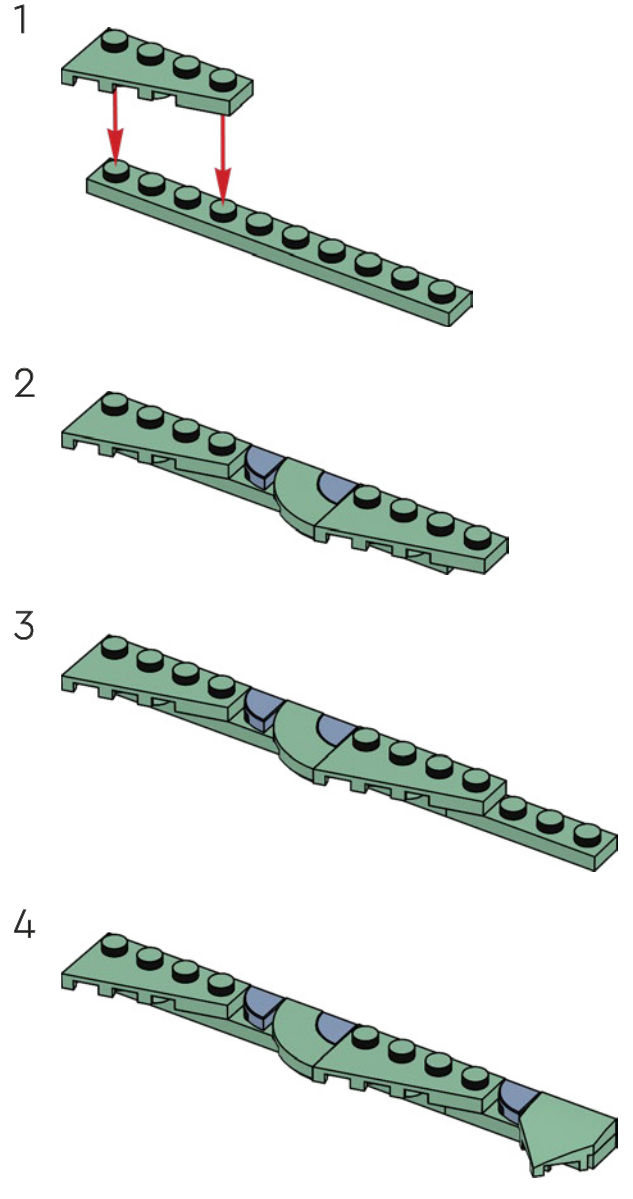
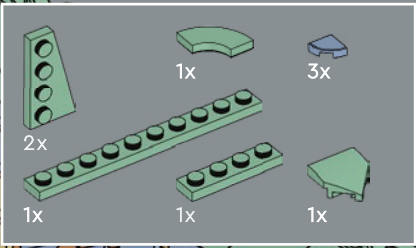

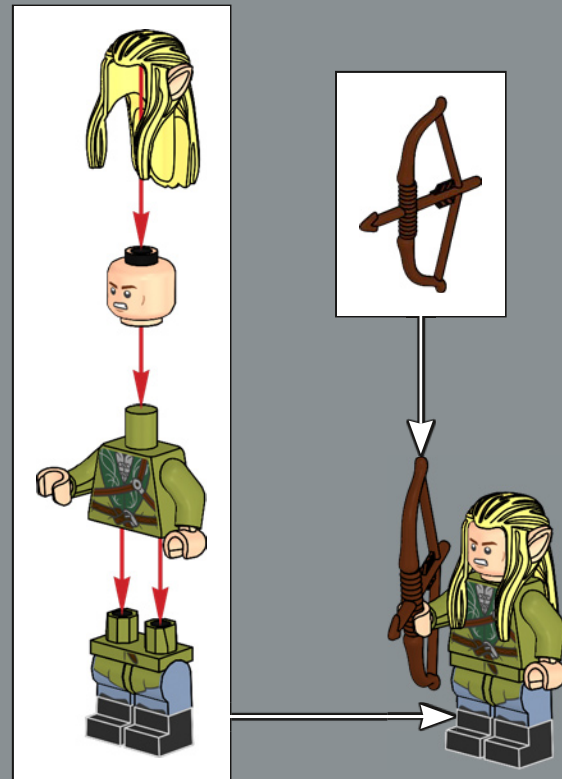

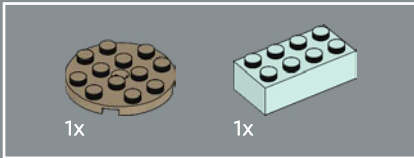
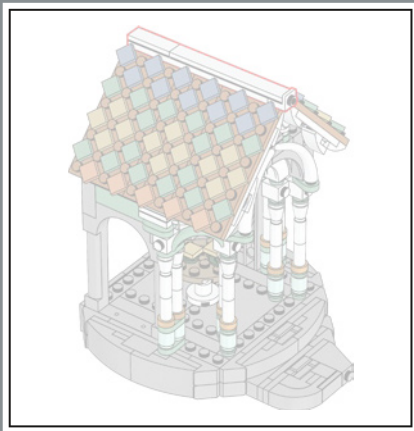

227

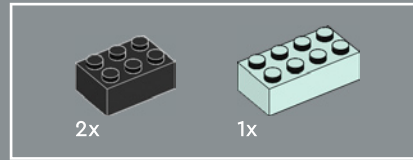
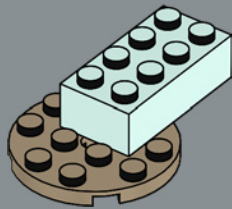

228

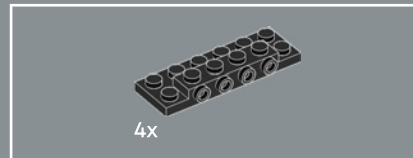
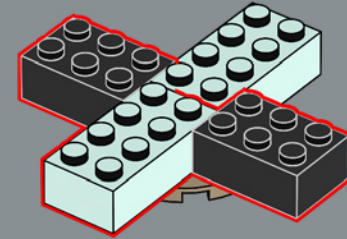

229

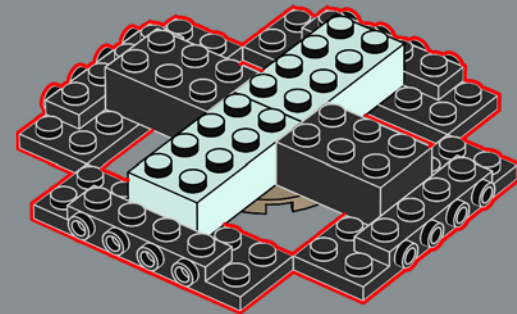

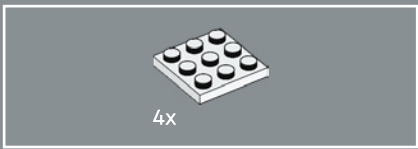

230

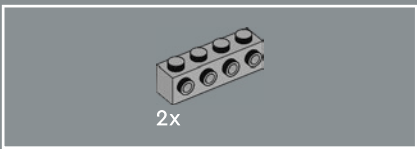
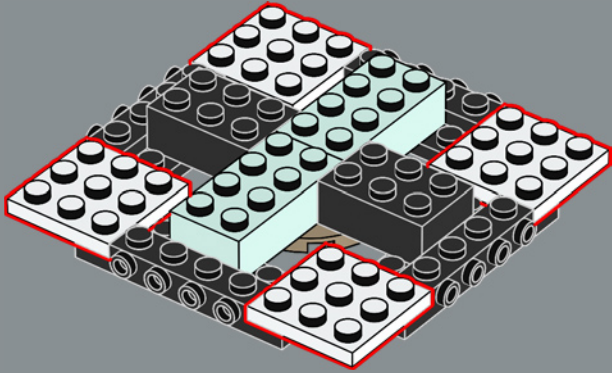

232

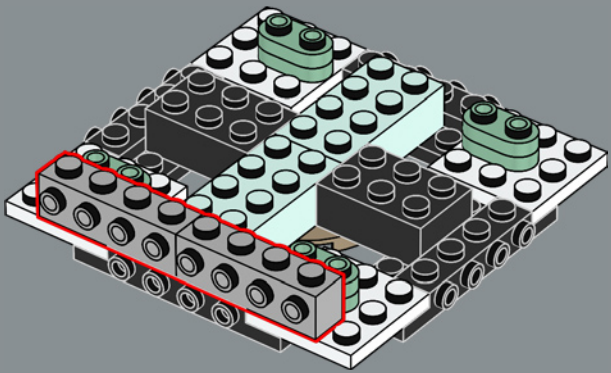

231

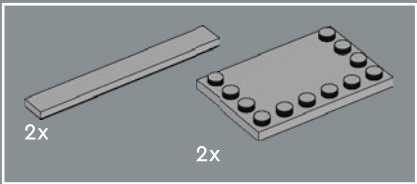
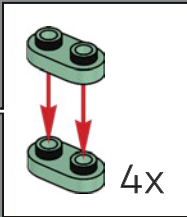
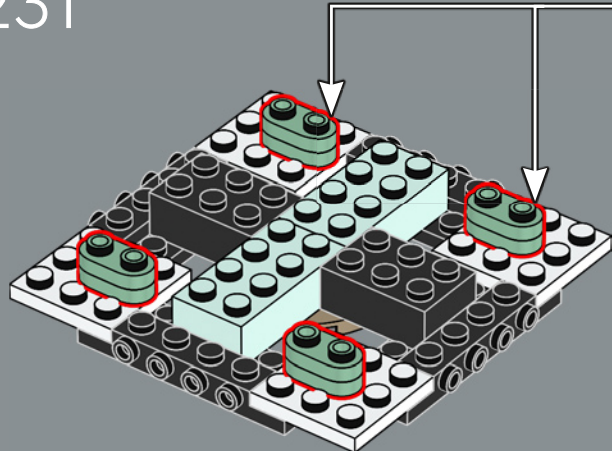

233

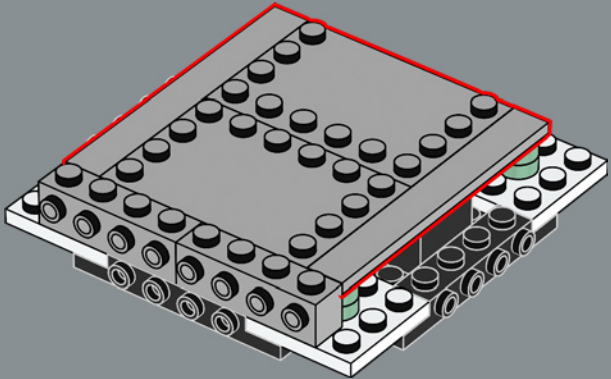

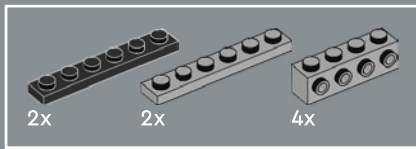

234

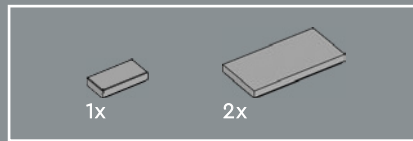
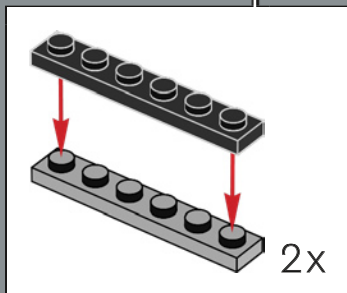
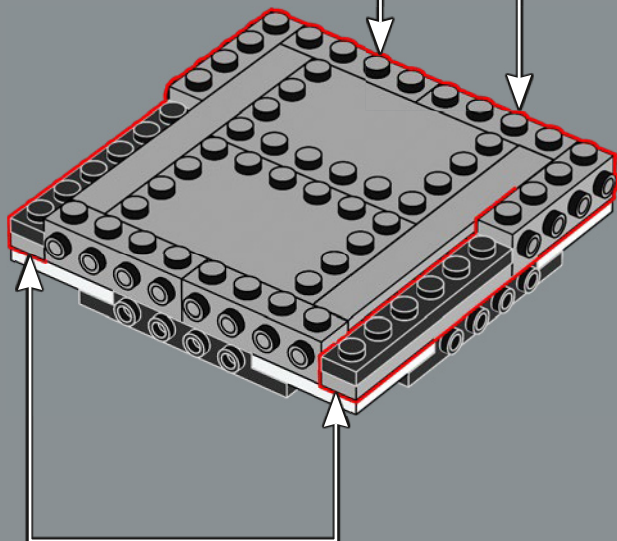
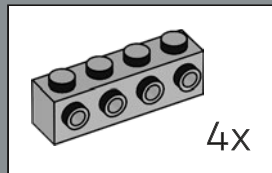

235

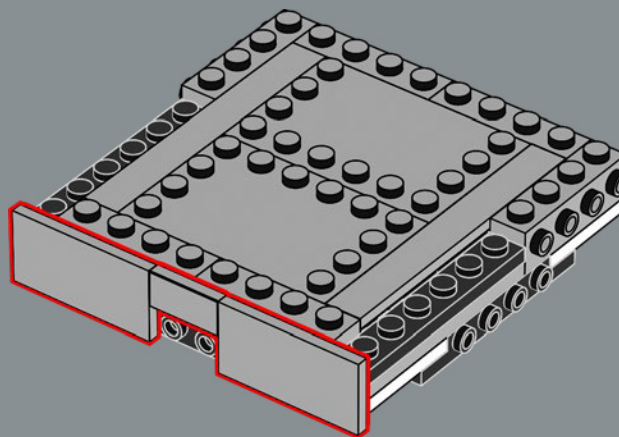

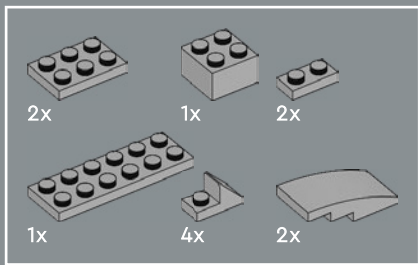

236

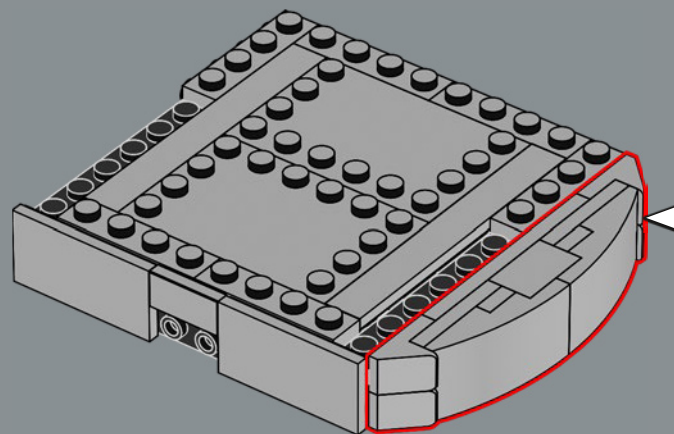
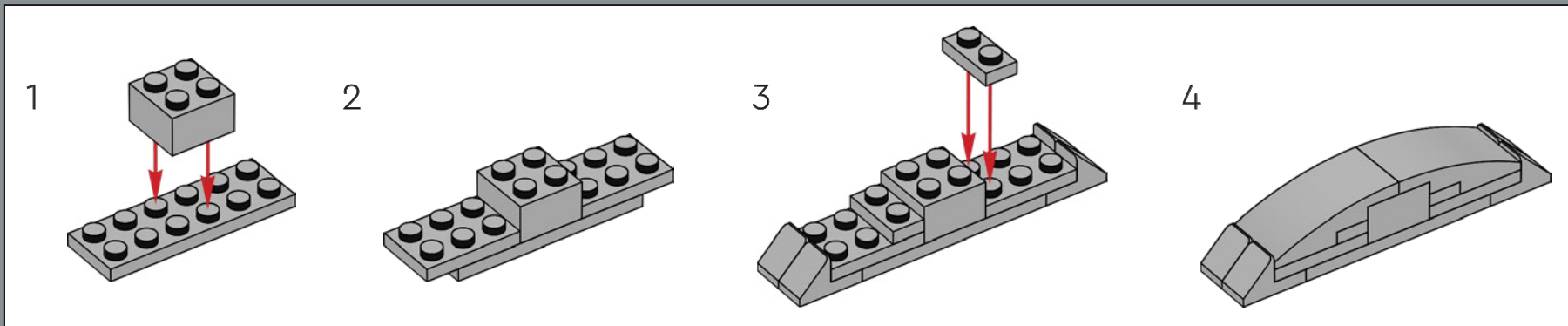

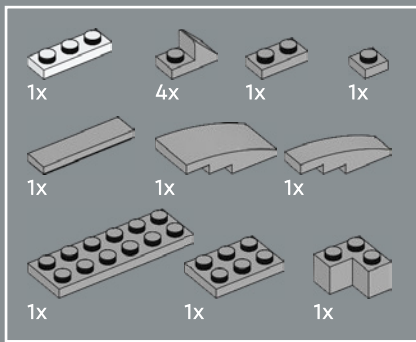

237

1

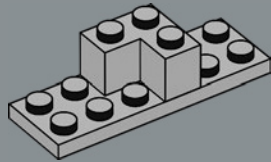

2

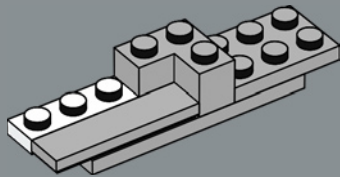

3

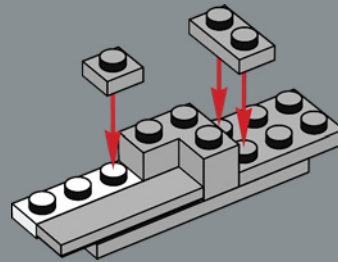

4

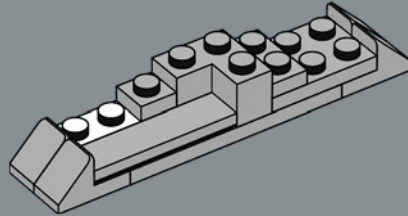

5

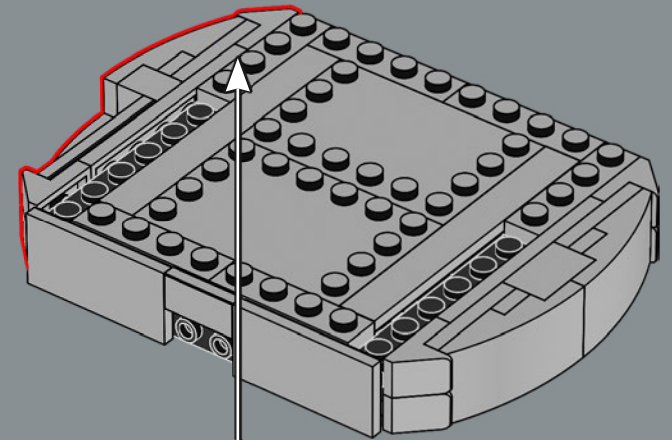
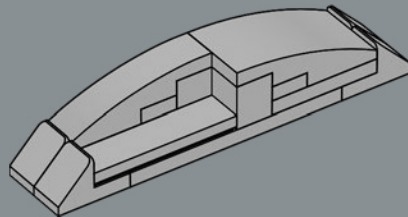

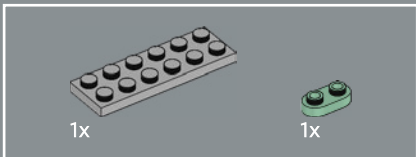
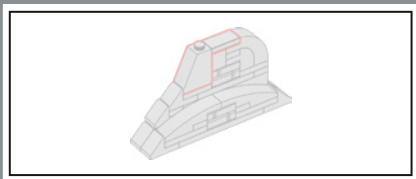

238

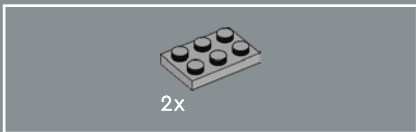
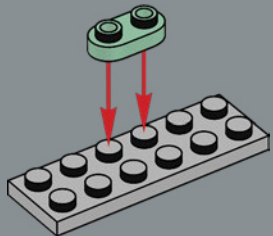

239

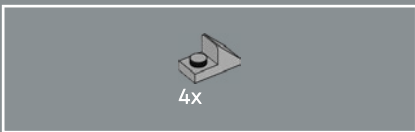
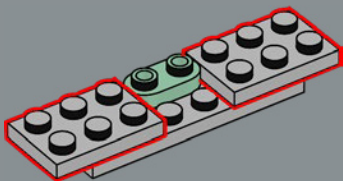

240

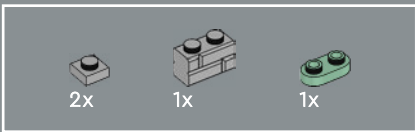
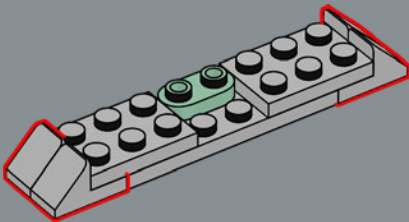

241

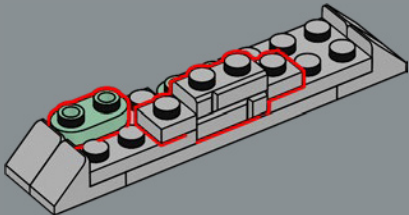

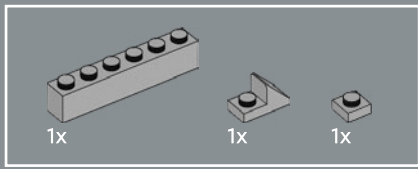

242

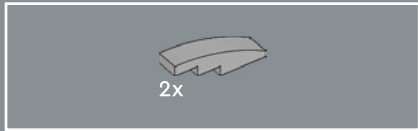
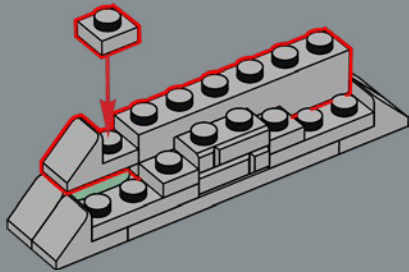

243

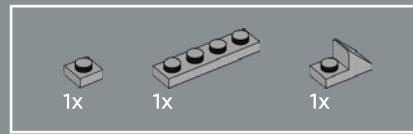
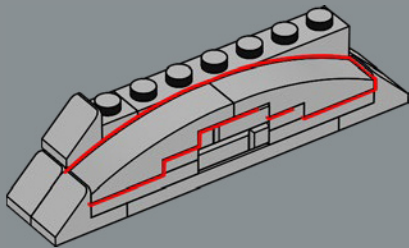

244

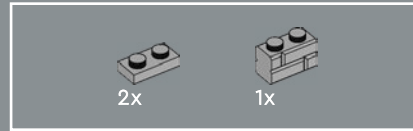
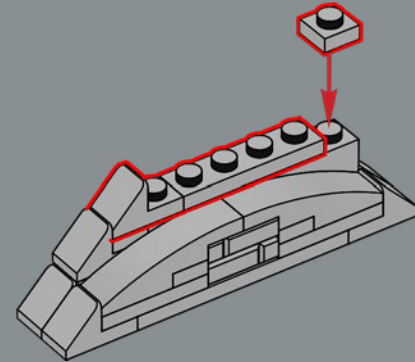

245

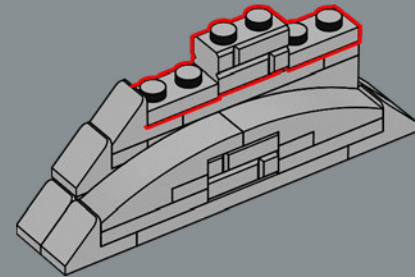

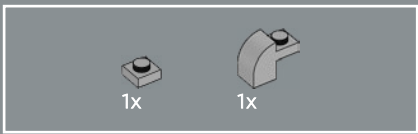

246

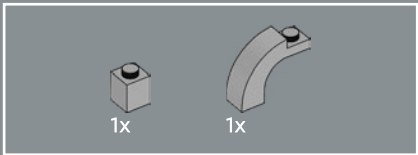
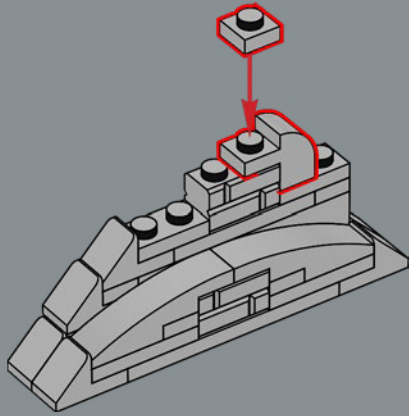

247

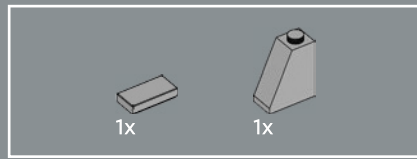
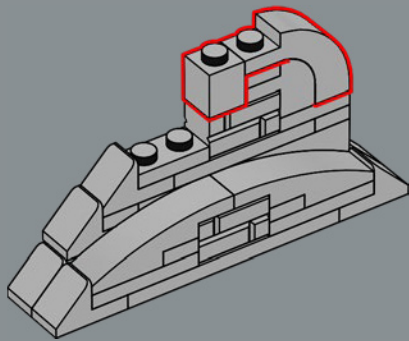

248

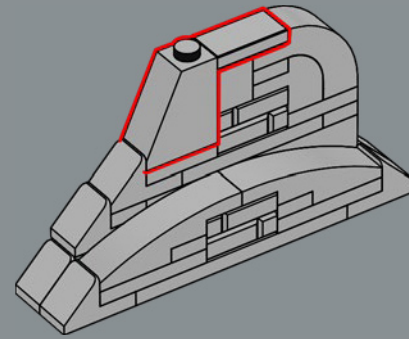

249

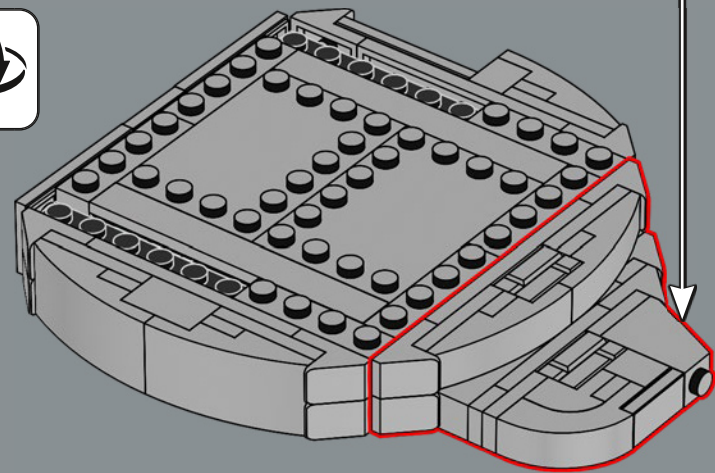

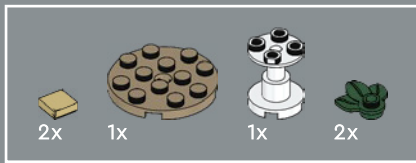

250

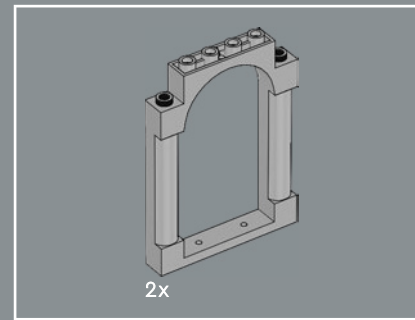
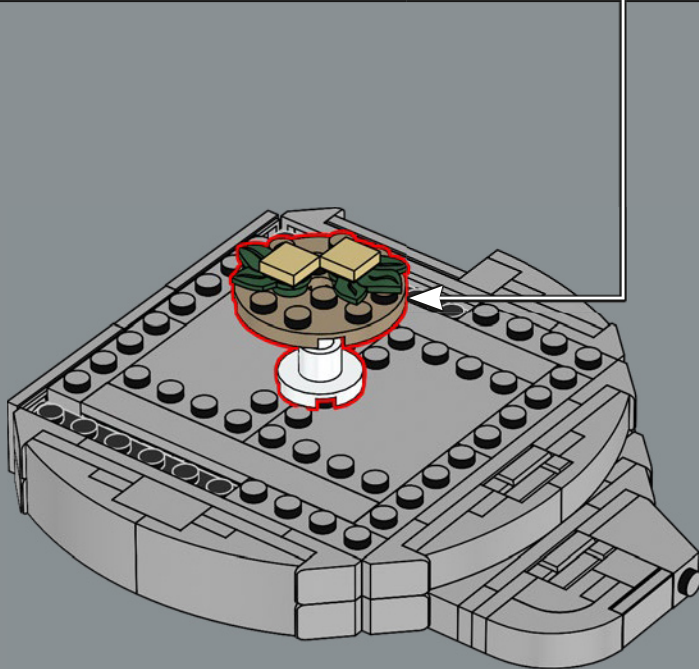
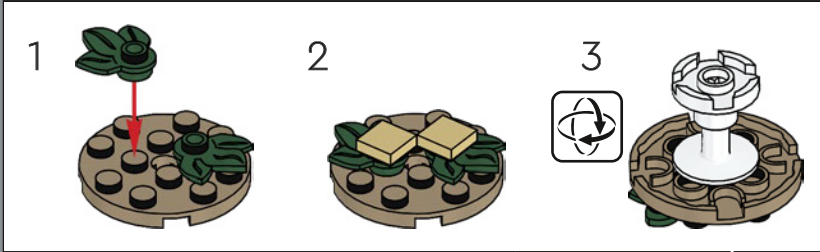

251

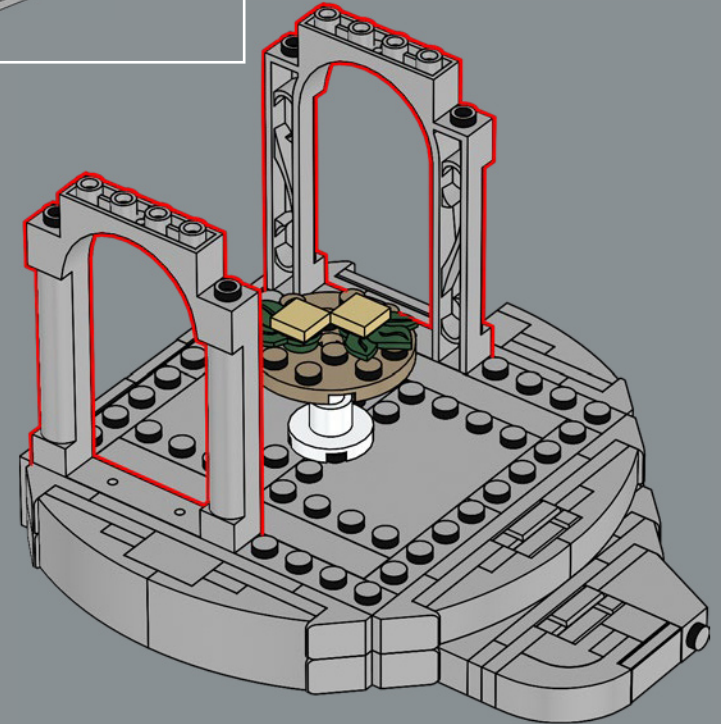

Lembas! Was für ein Brot! Von einer einzigen 1x1 Kachel kann eine Minifigur eine ganze Weile zehren.





252

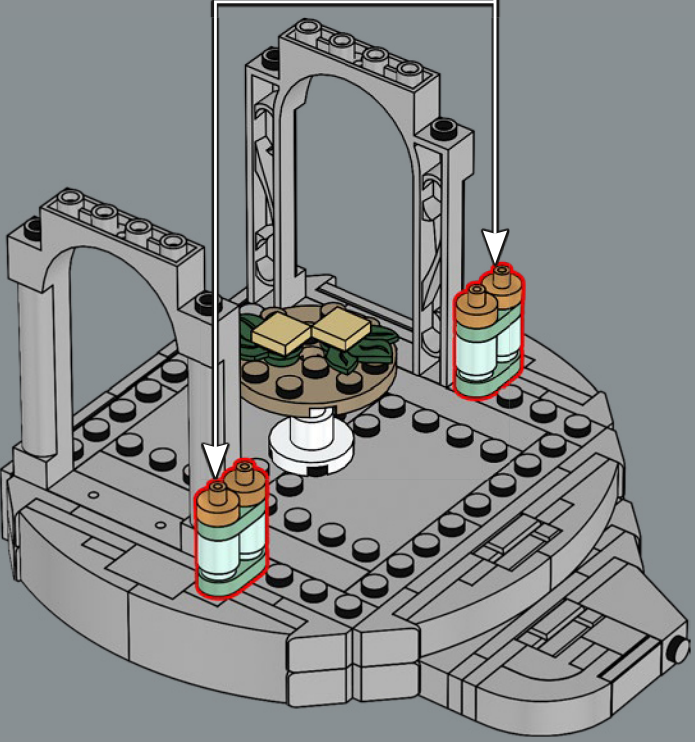
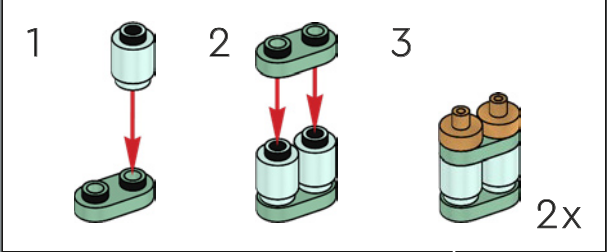

253

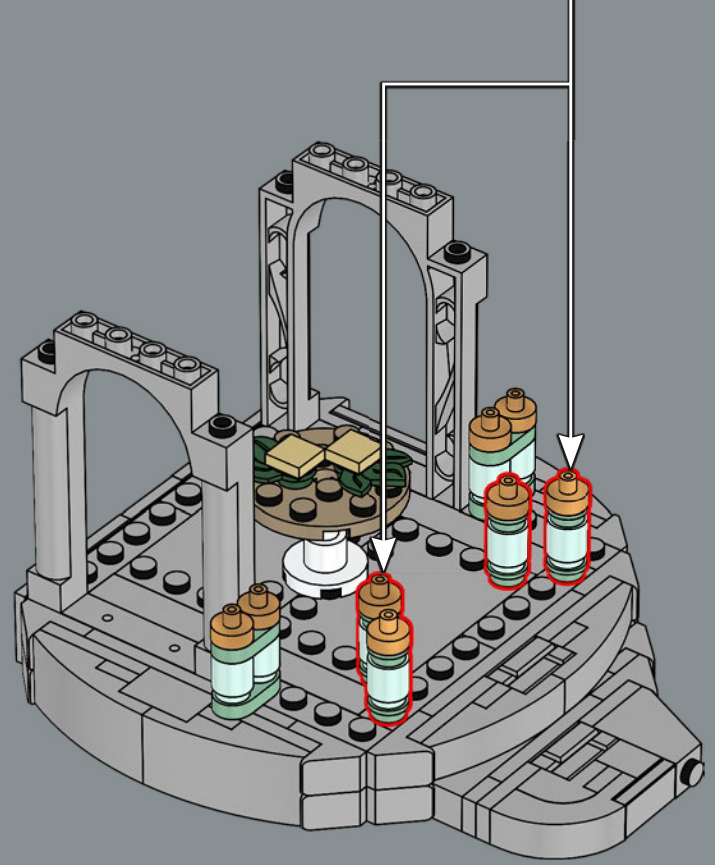
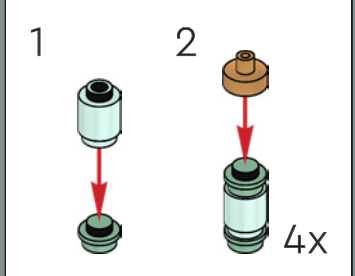

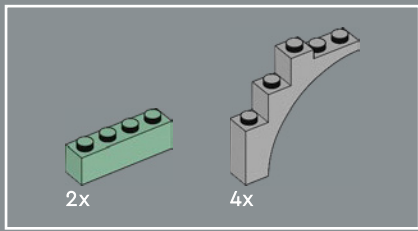

254

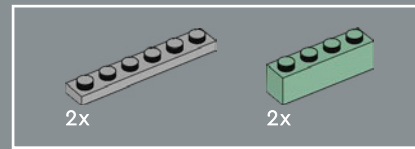
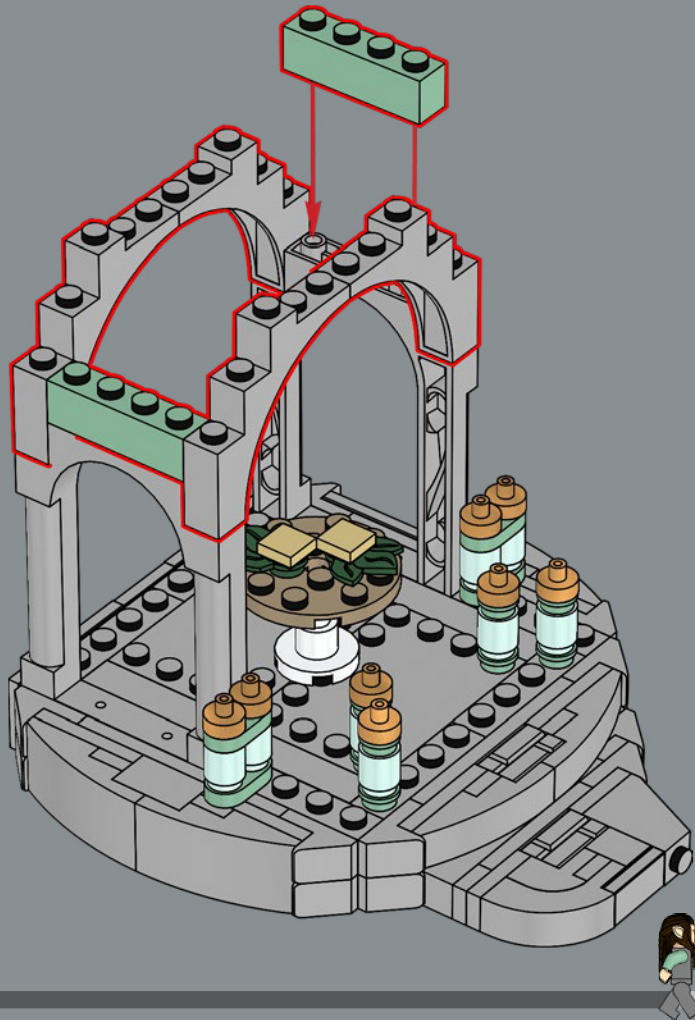

255

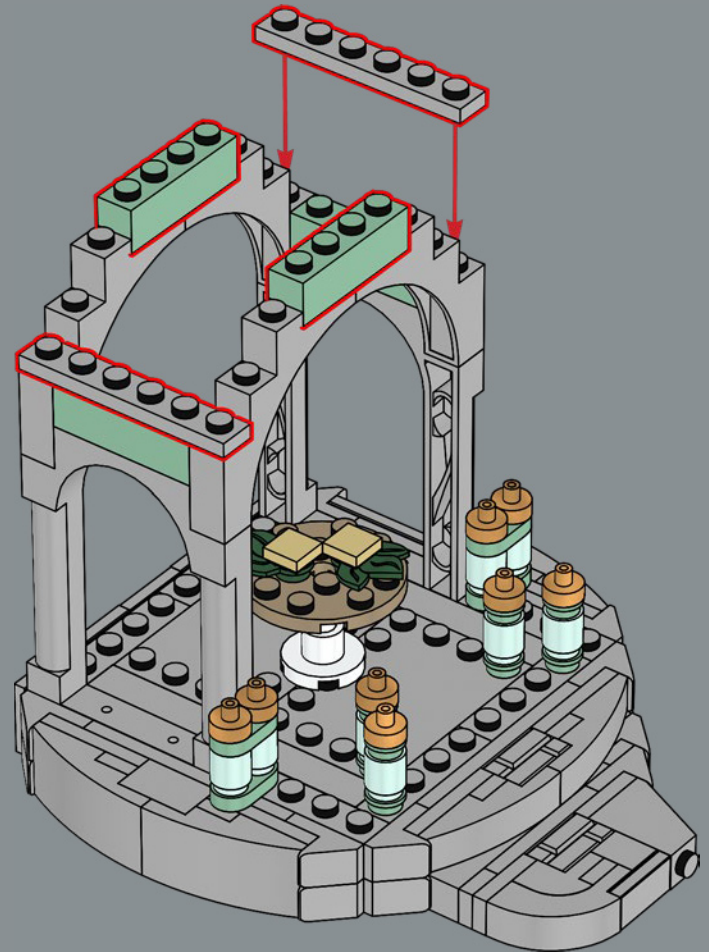

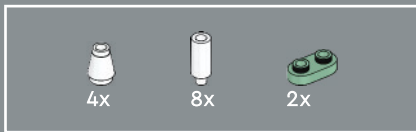

256

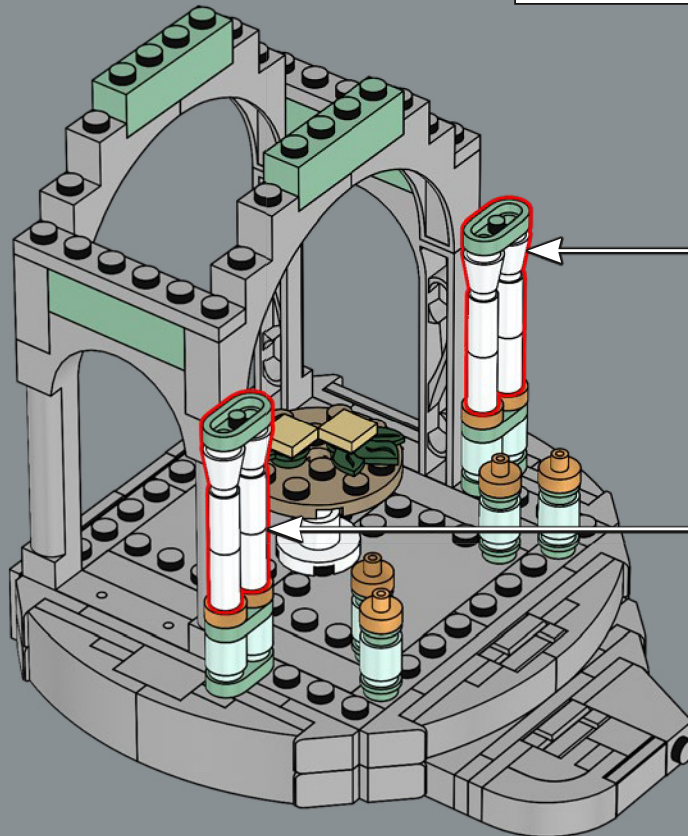
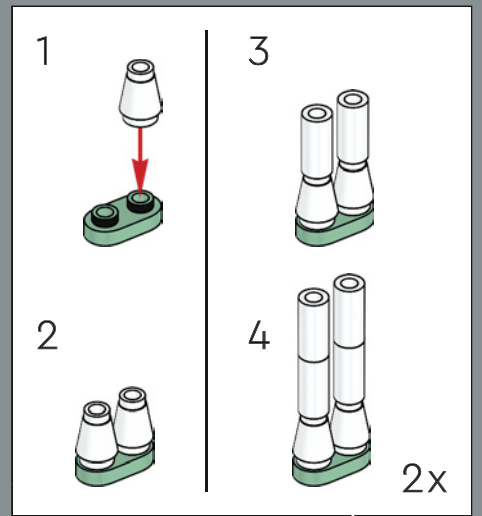

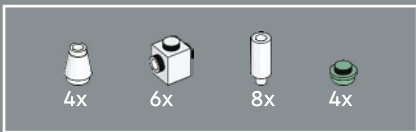

257

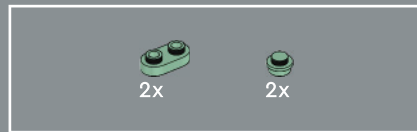
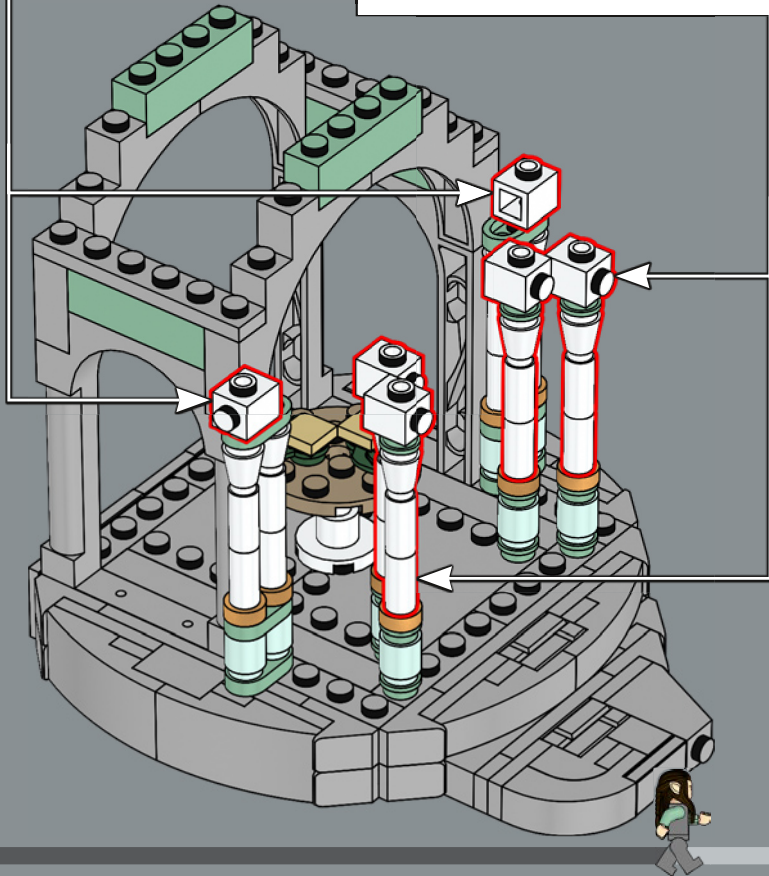
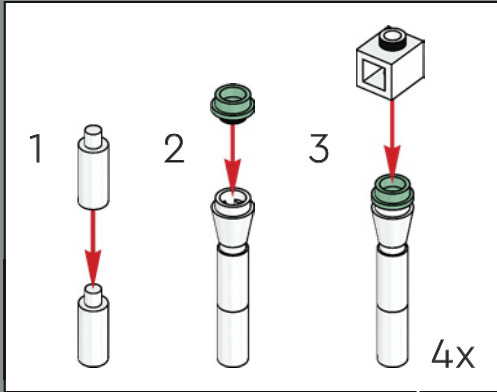
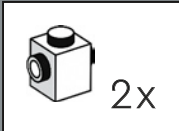

258

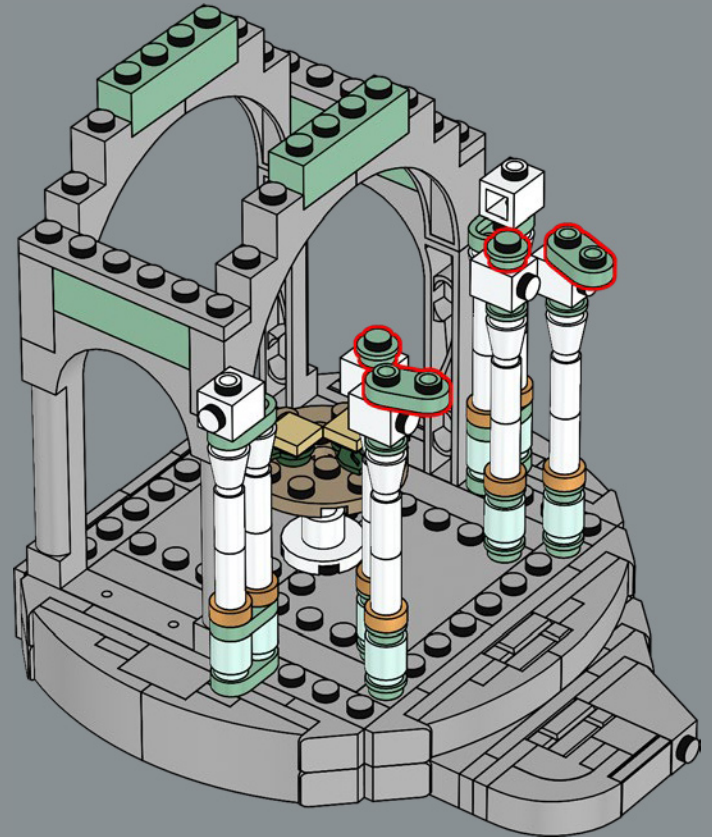

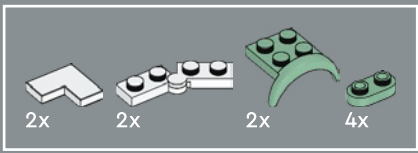

259

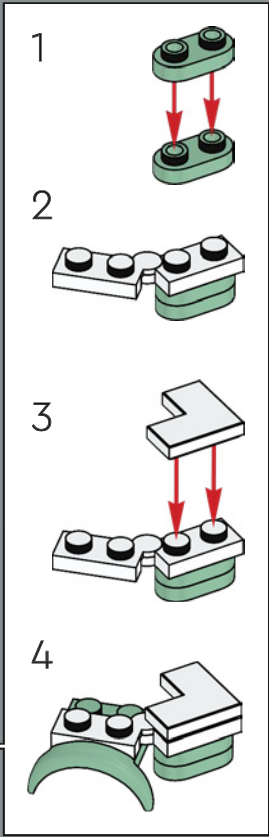
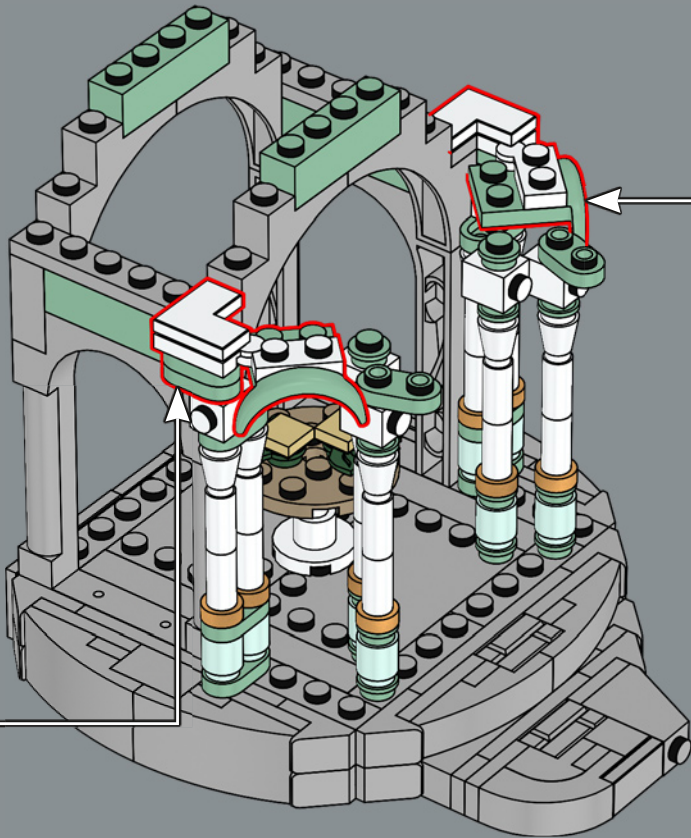
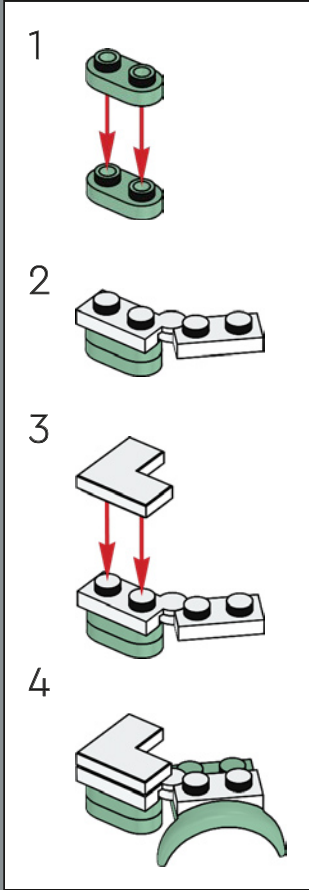

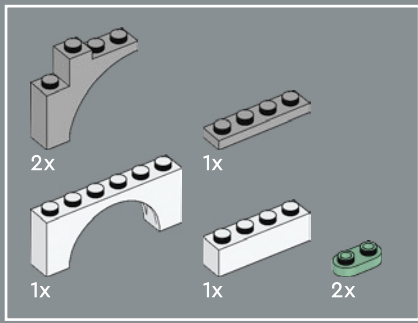

260

1

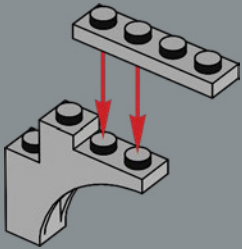

2

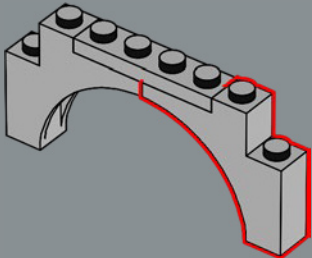

3

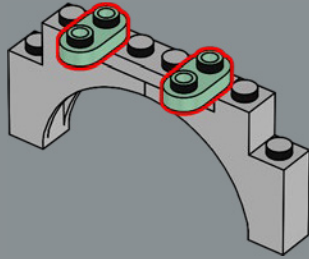

4

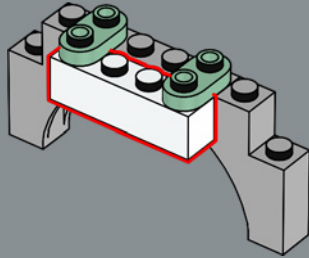

5

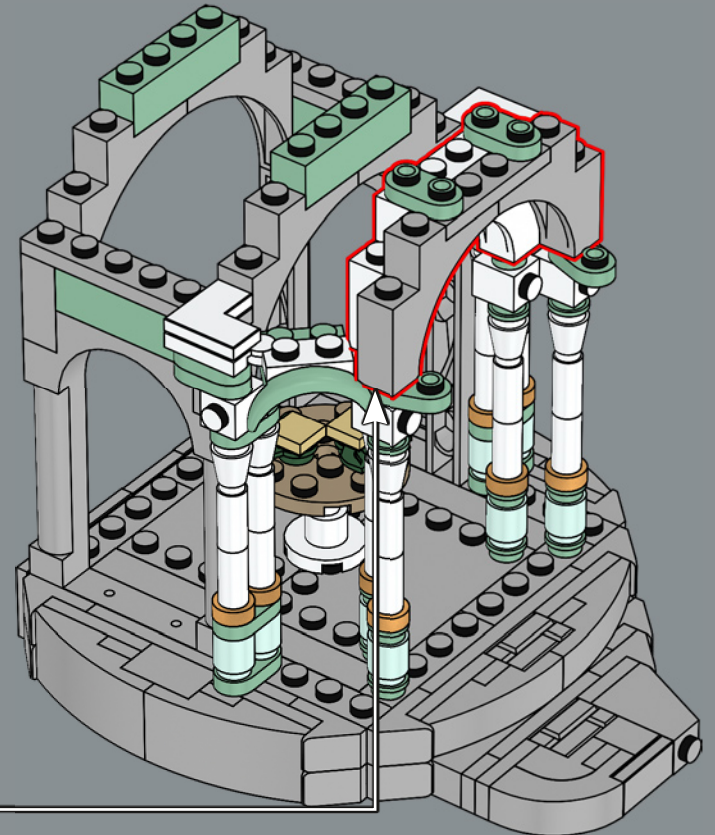
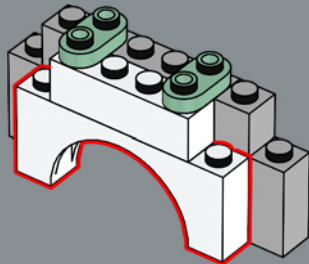

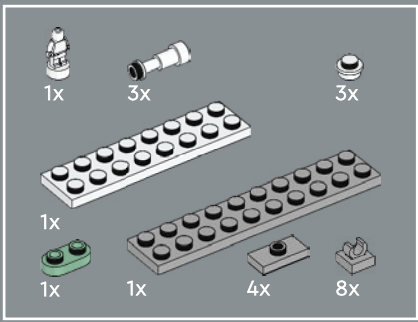

261

1

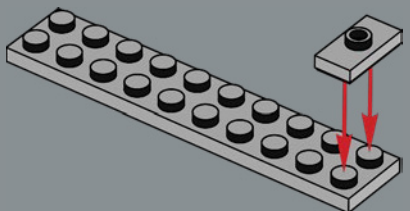

2

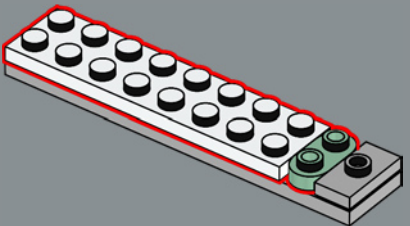

3

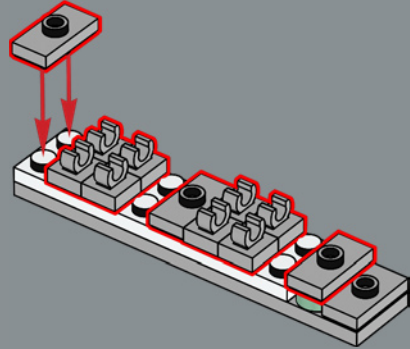

4

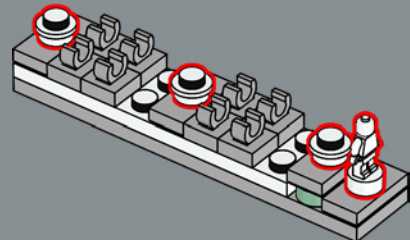

5

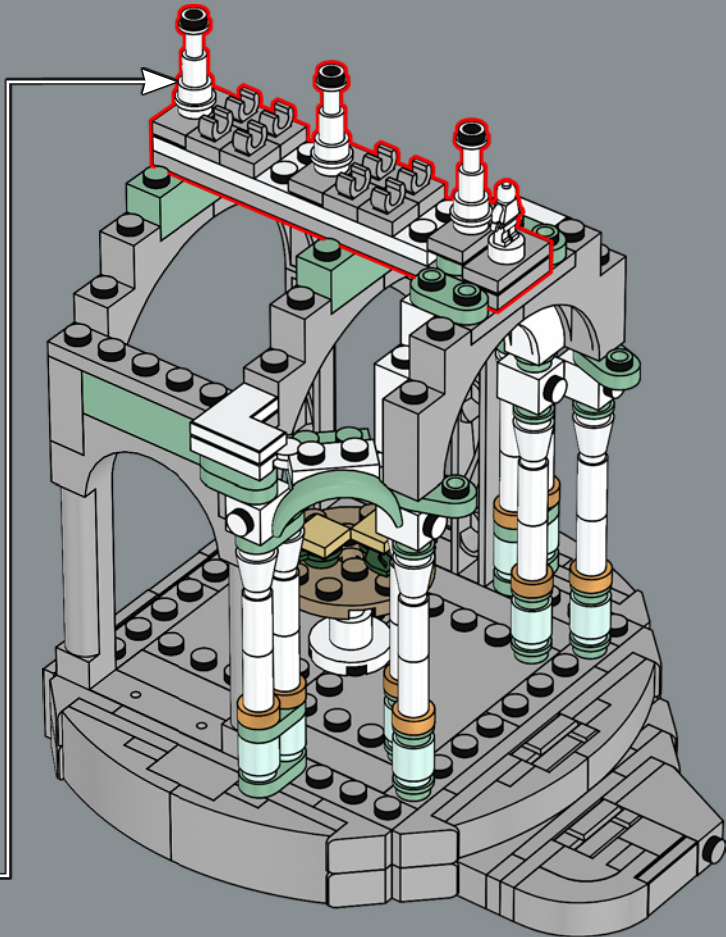
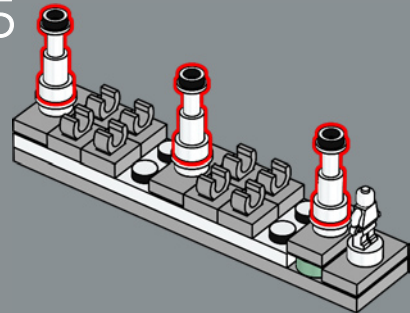



262

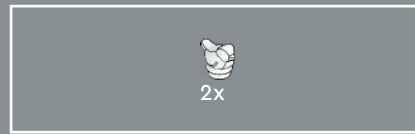
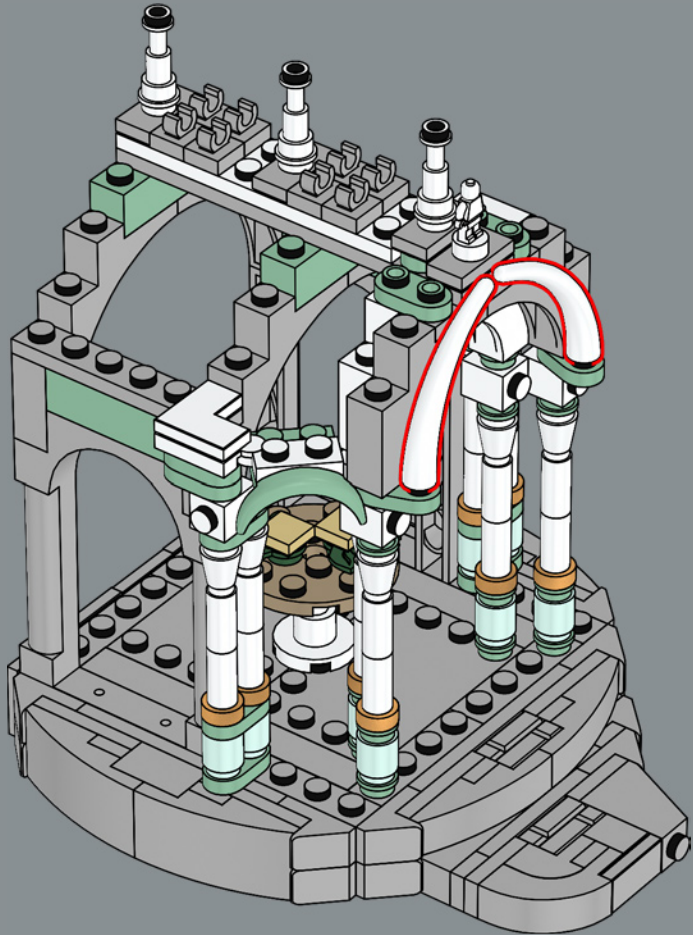

263

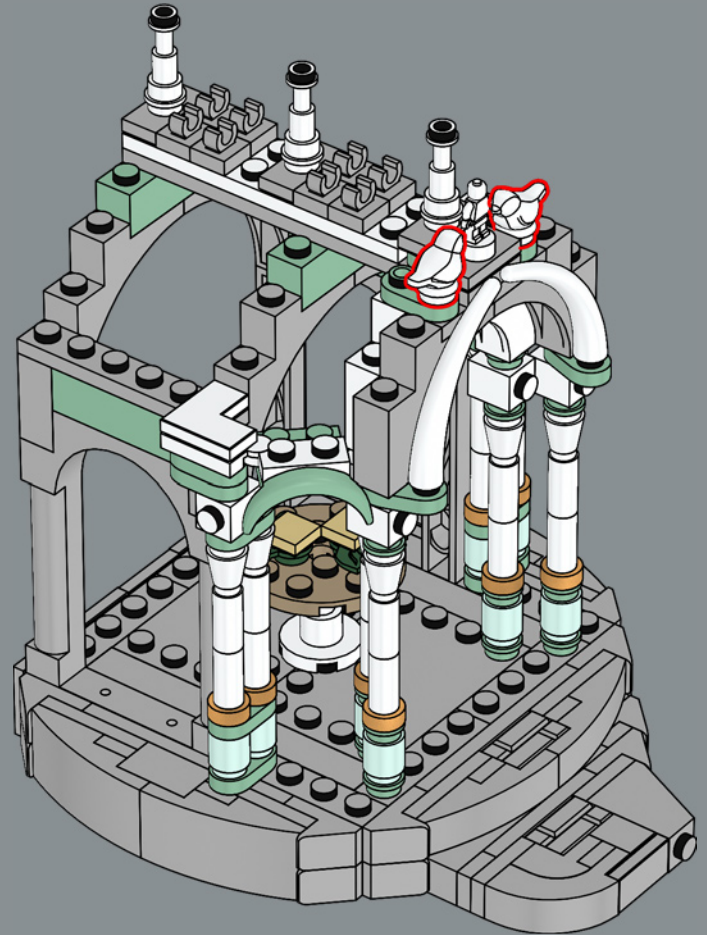

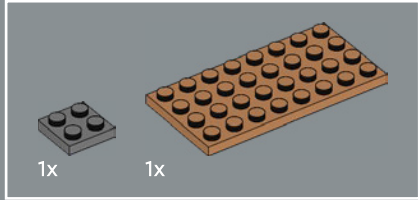
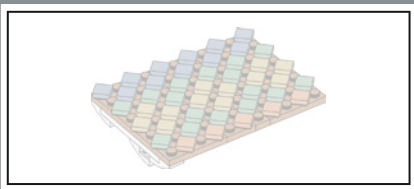

264

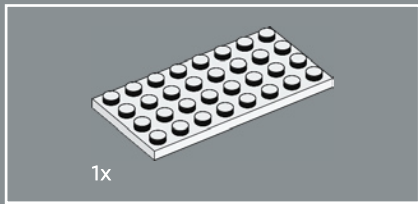
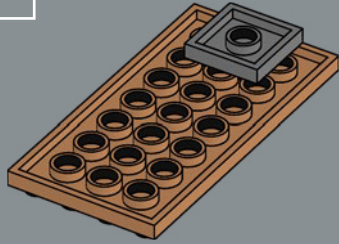

265

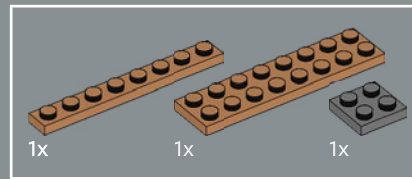
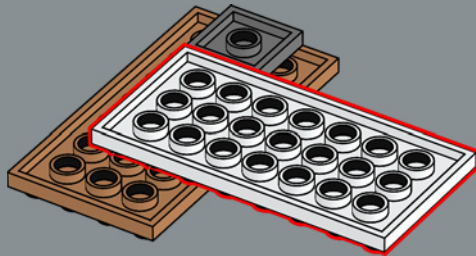

266

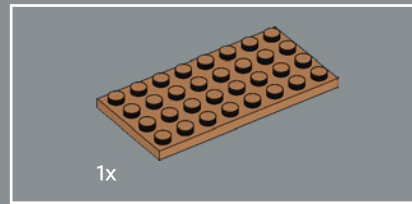
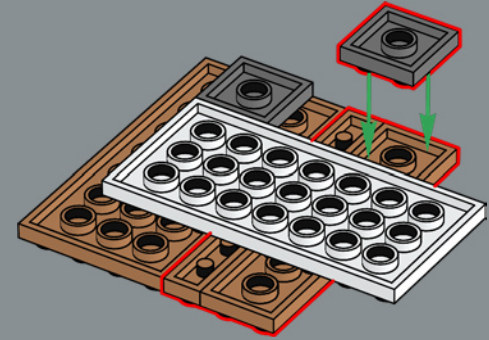

267

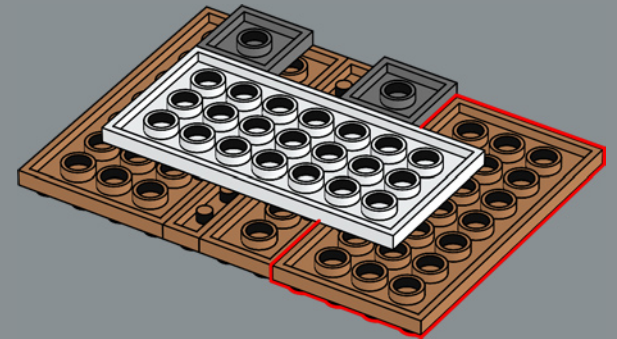

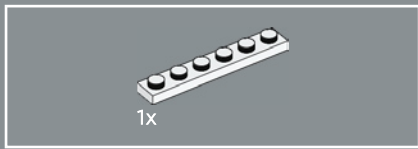

268

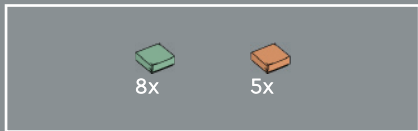
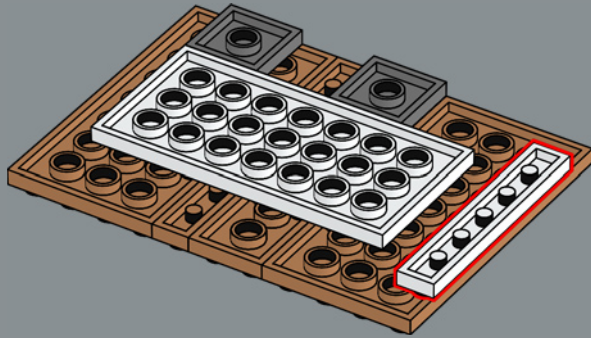

269

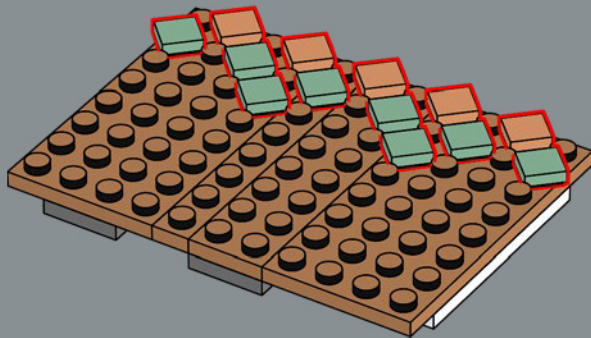

270

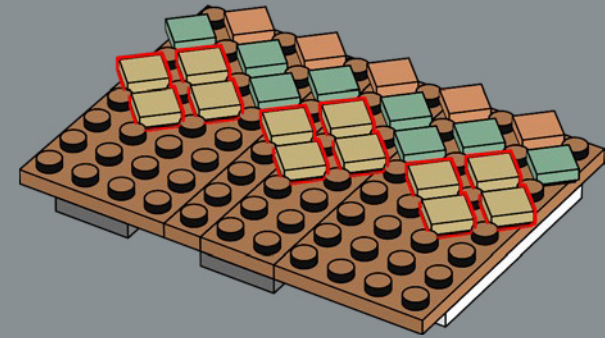

271

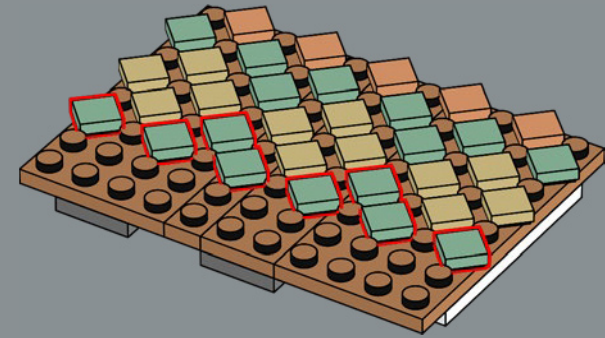



11x

272

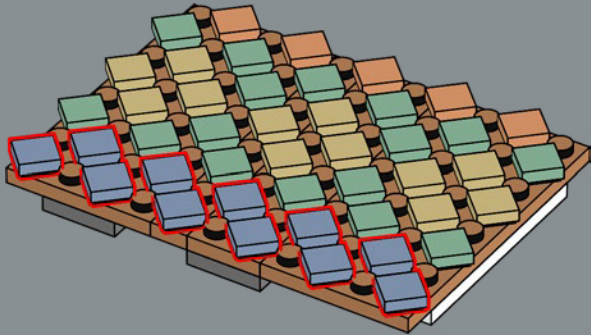

1x

3x

2x

273

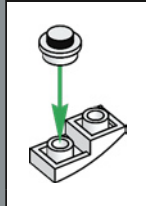
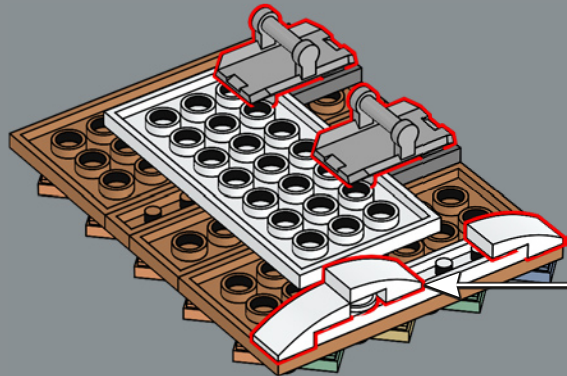

274

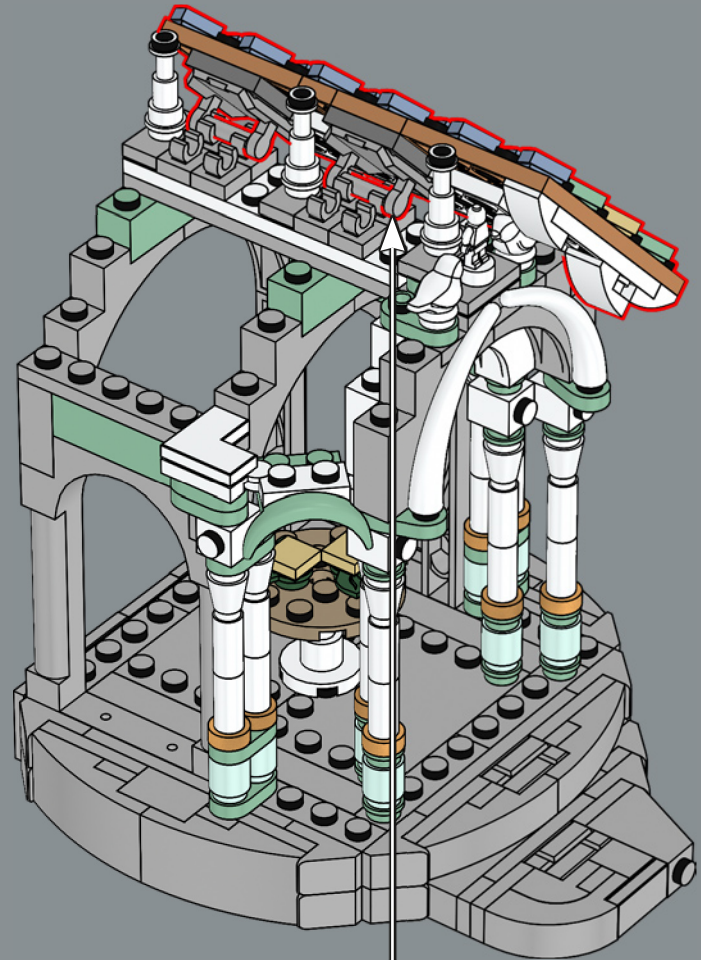

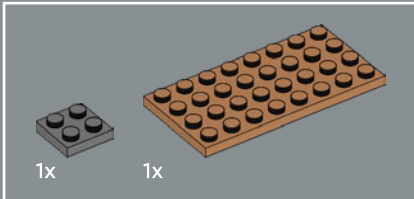
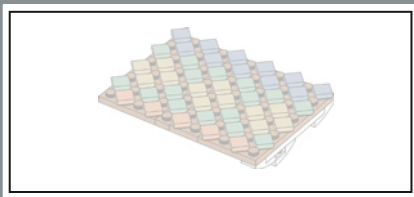

275

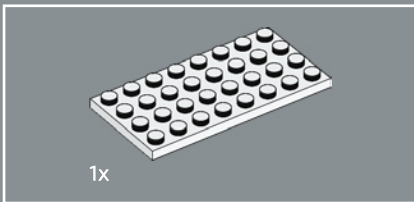
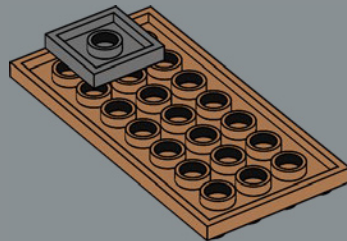

276

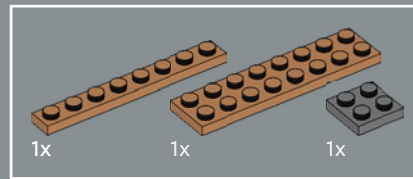
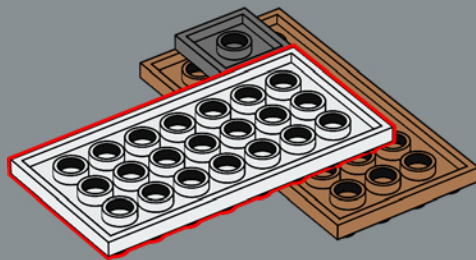

277

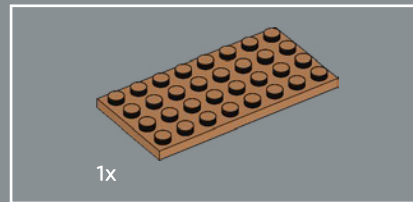
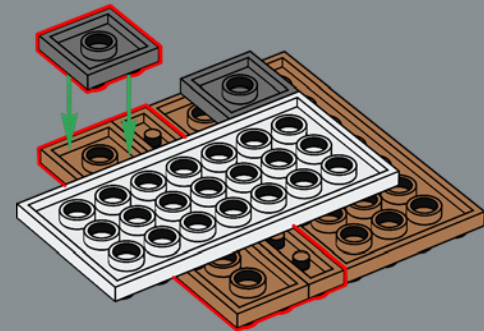

278

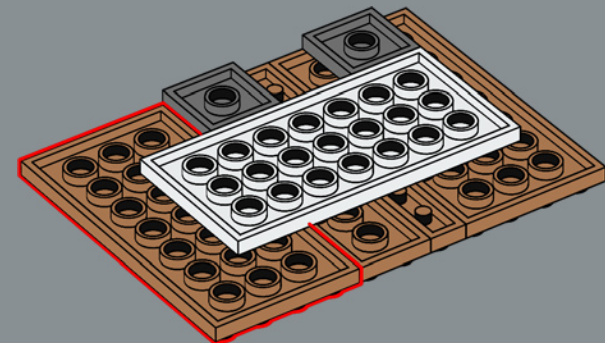

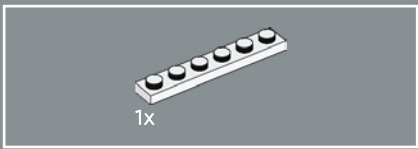

279

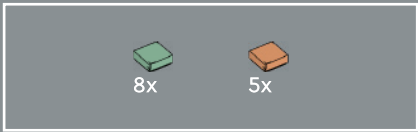
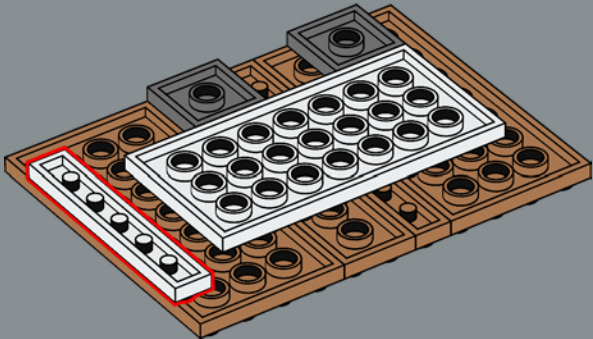

280

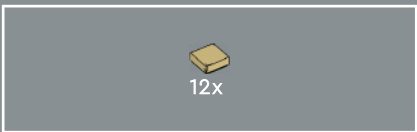
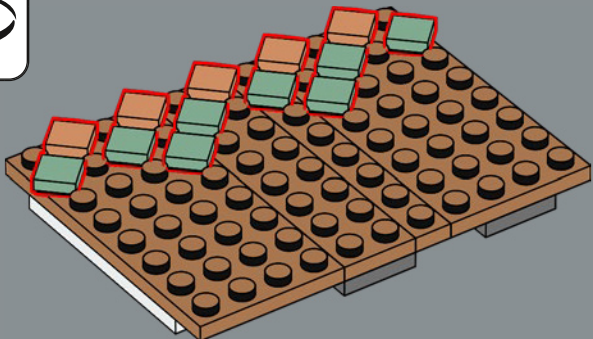

281

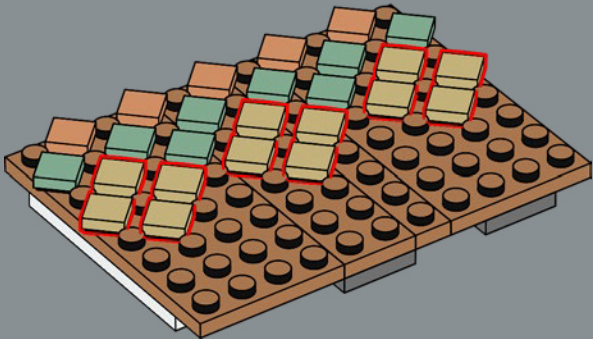

282

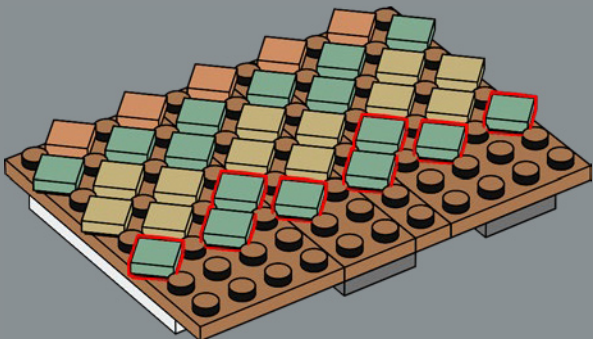



283

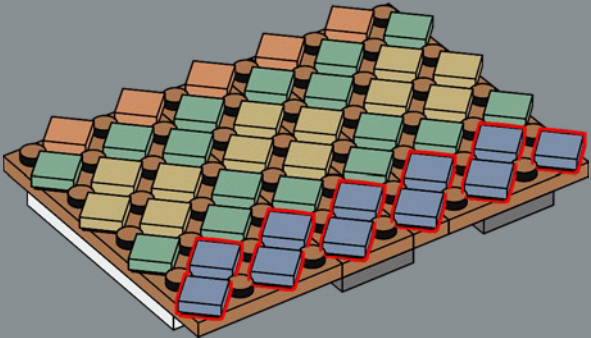

284

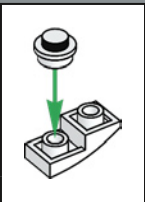
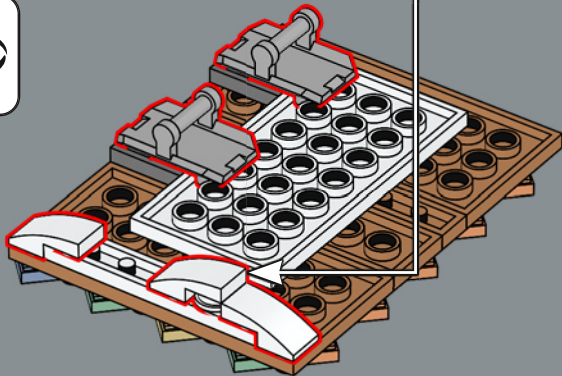

285

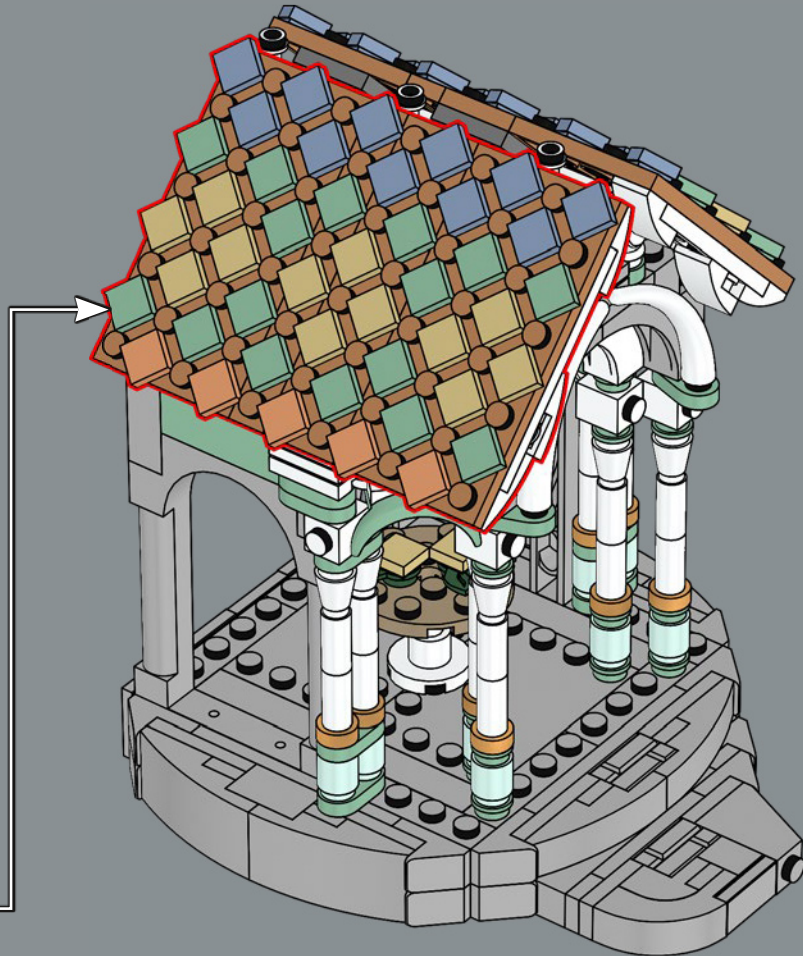

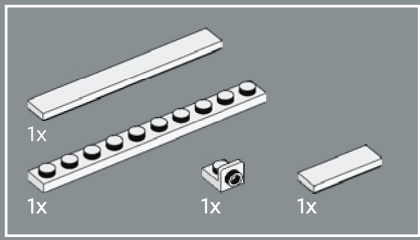

286

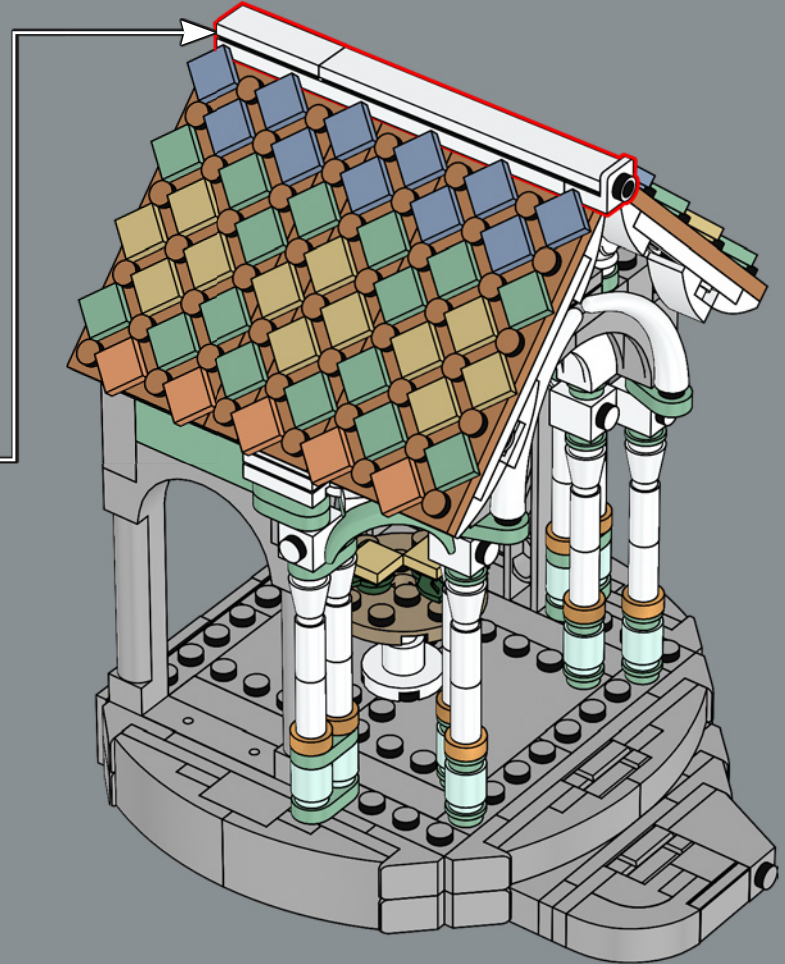
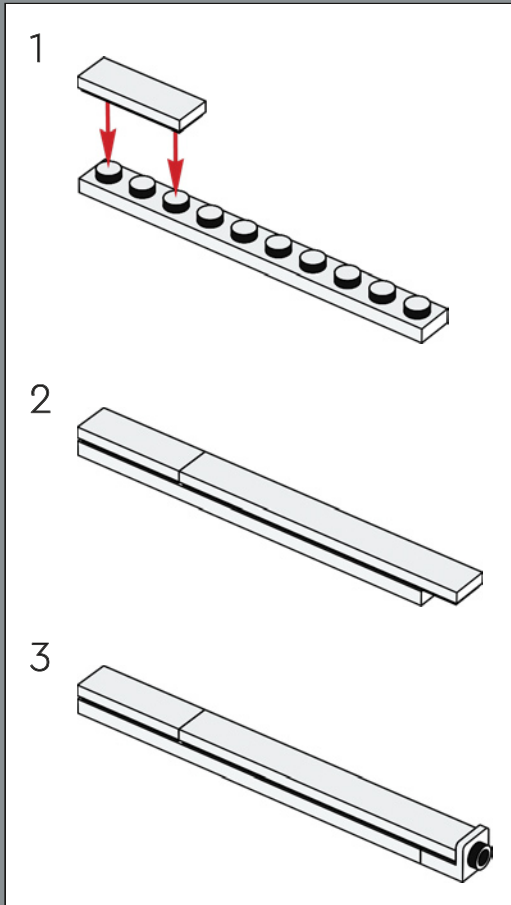

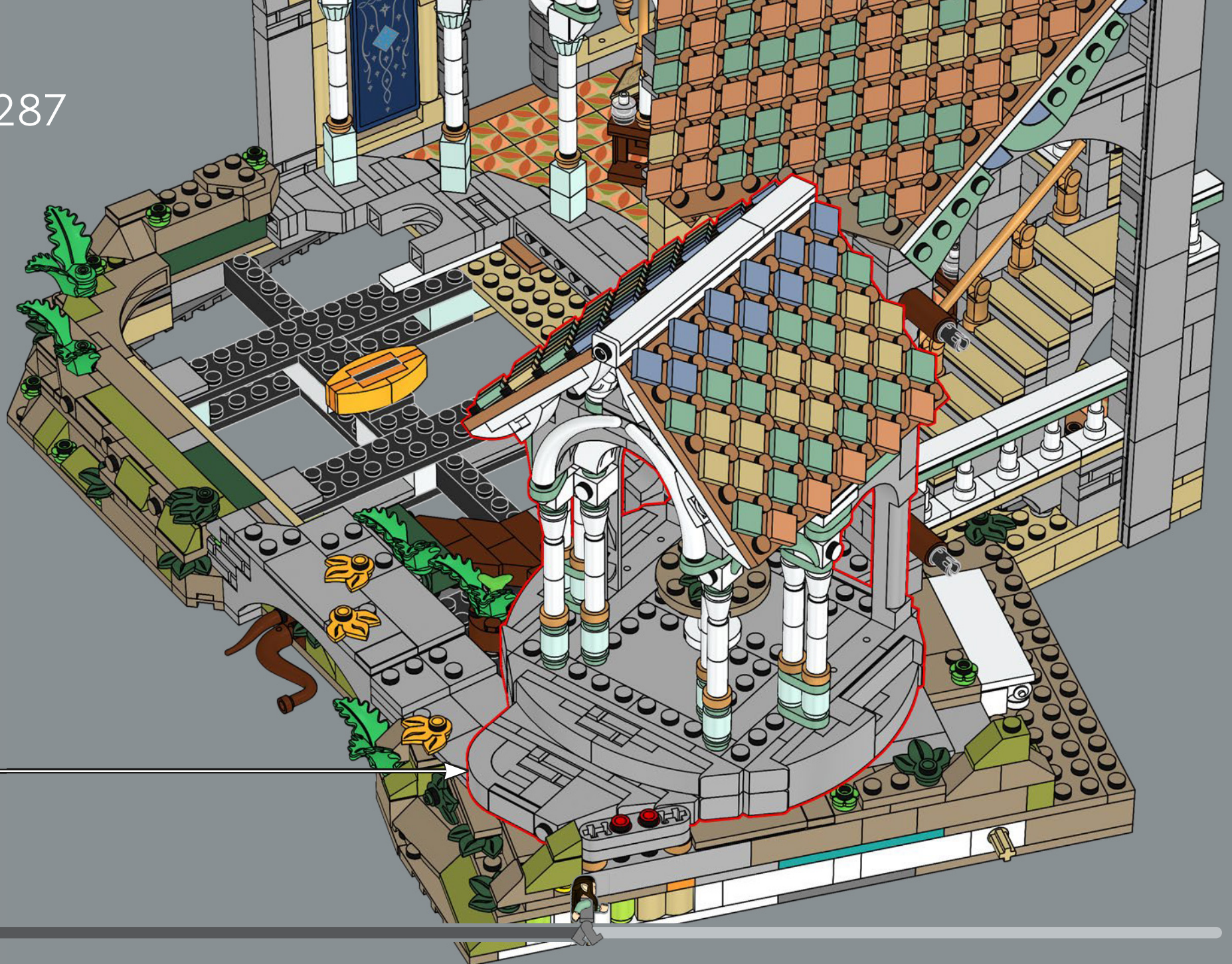

1x

288

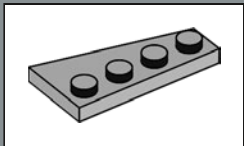

Diese Platte ist so angebracht, dass sie später eine perfekte Linie mit der Brücke bildet.

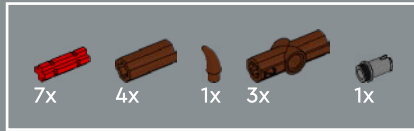
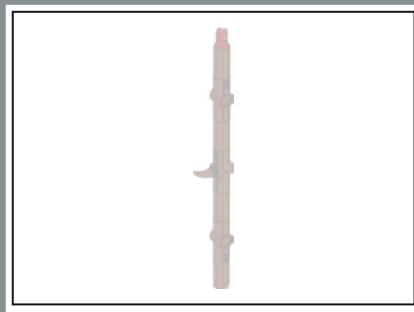

289

1



2



3



4

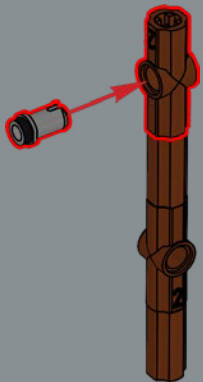

5

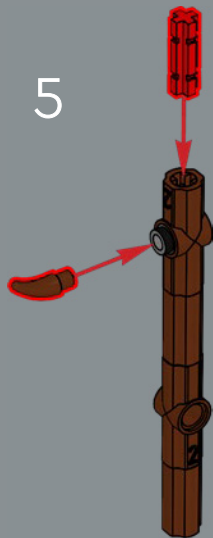

6



7



8



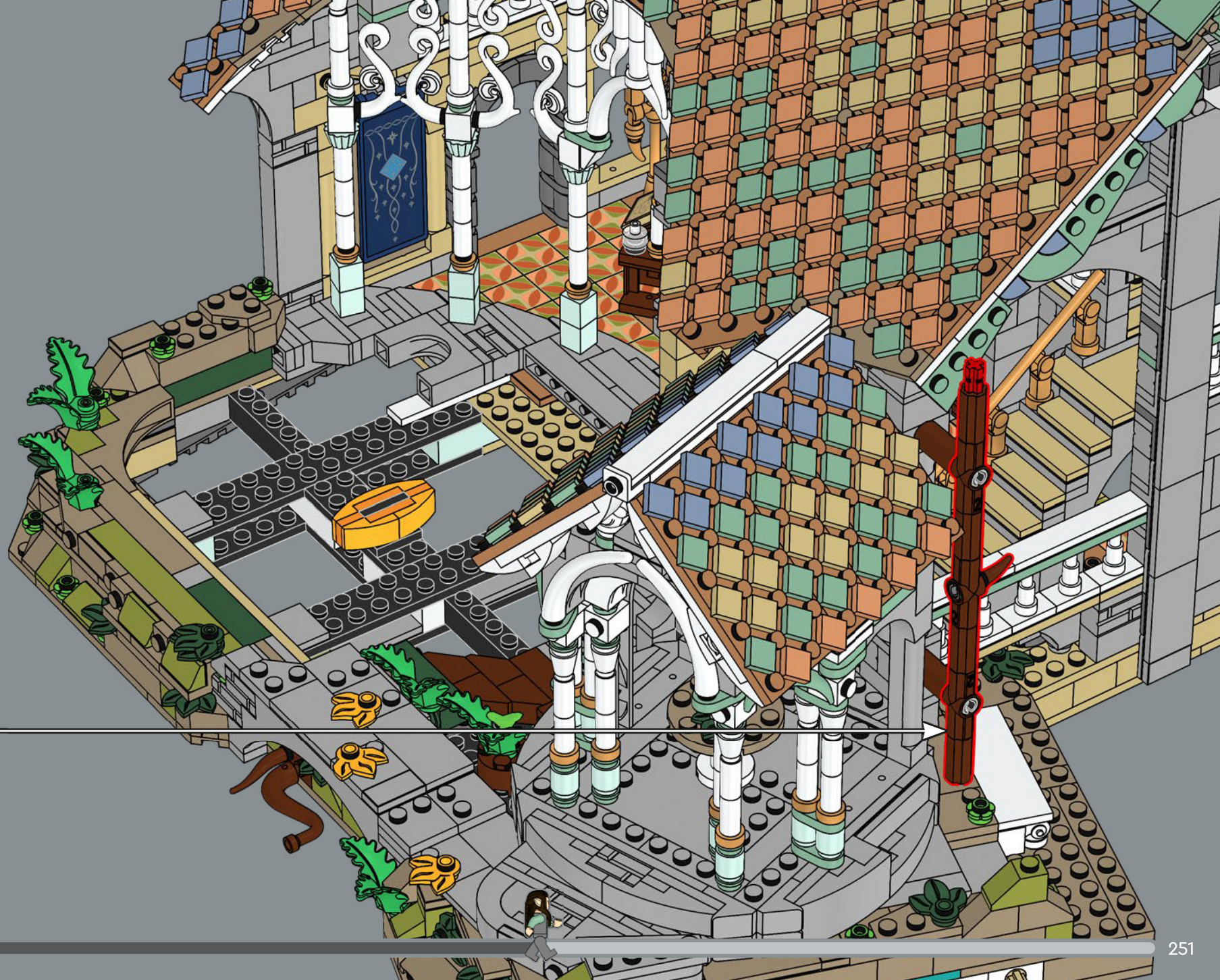

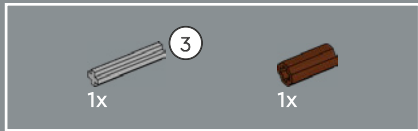
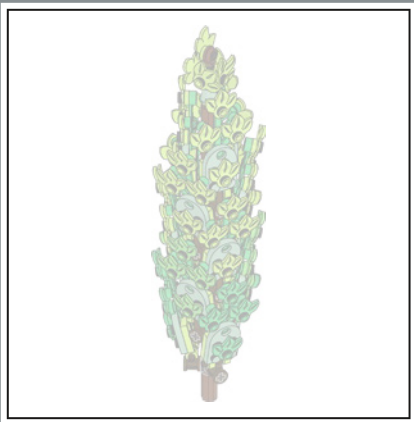

290



291

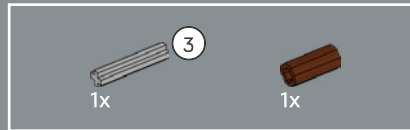
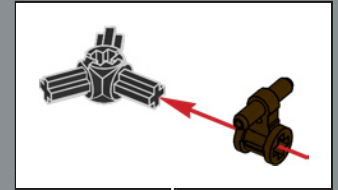
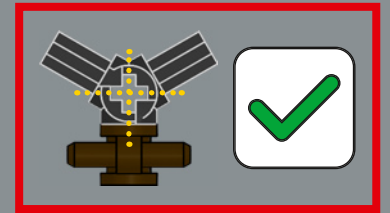

292

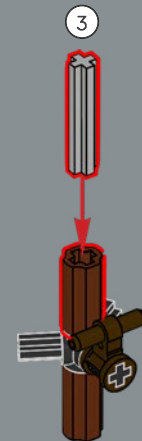

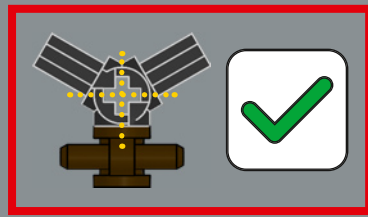

293

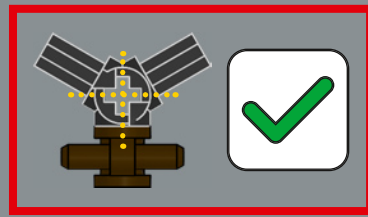
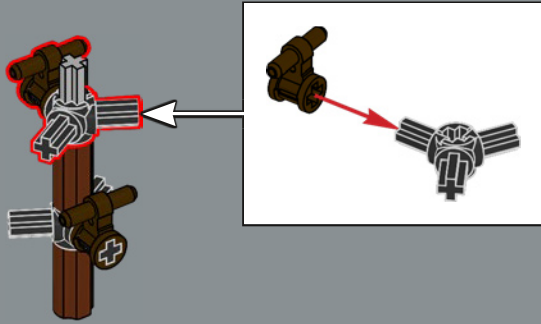

295

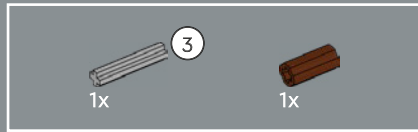
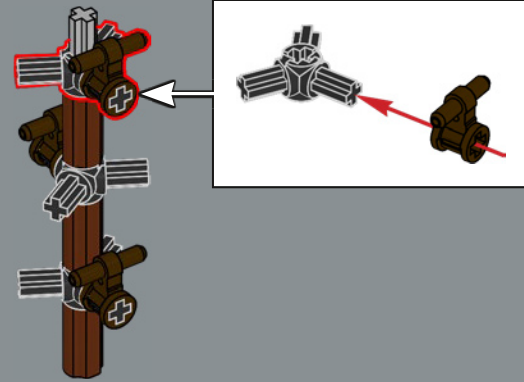

294

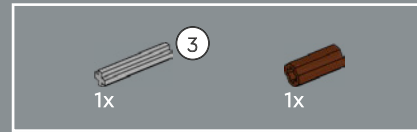
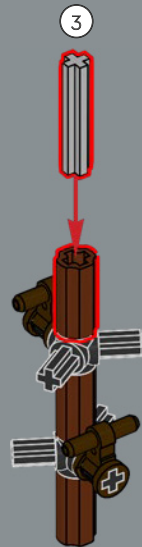

296





297

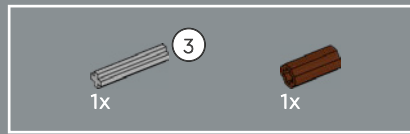
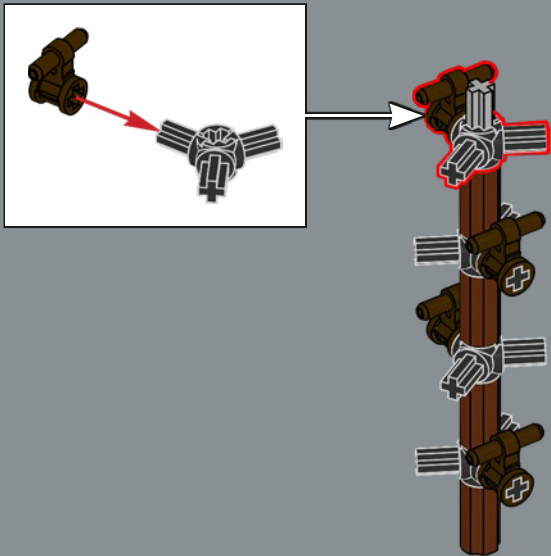
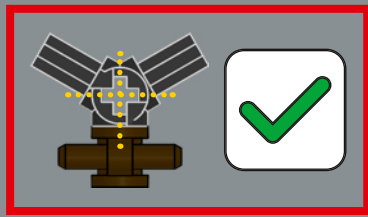

298





299

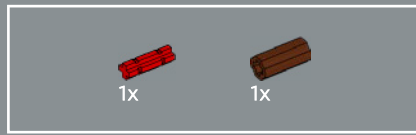
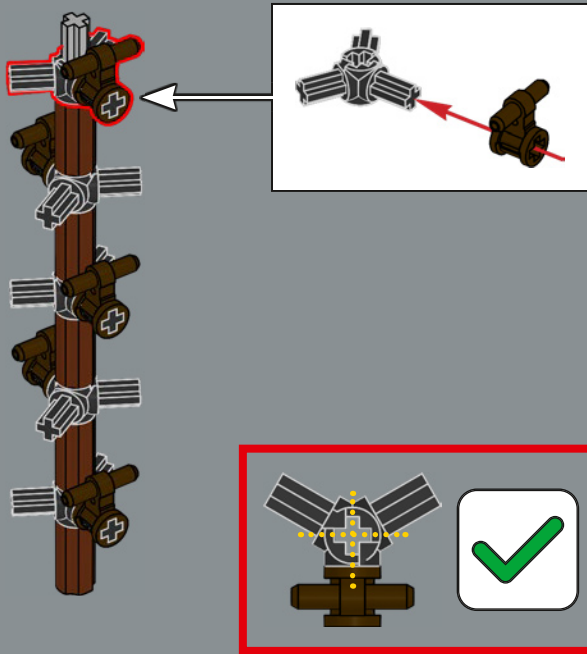

300

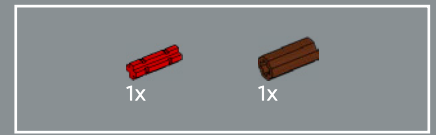

301



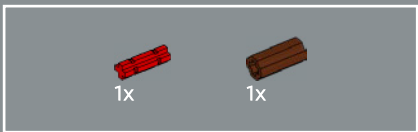

302



303



304

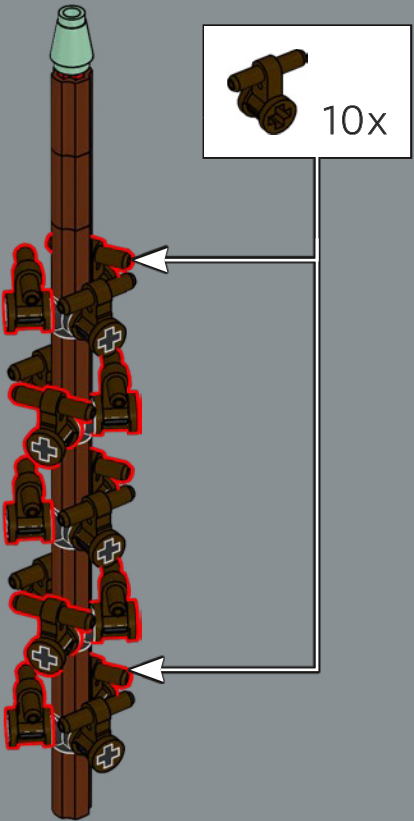



305

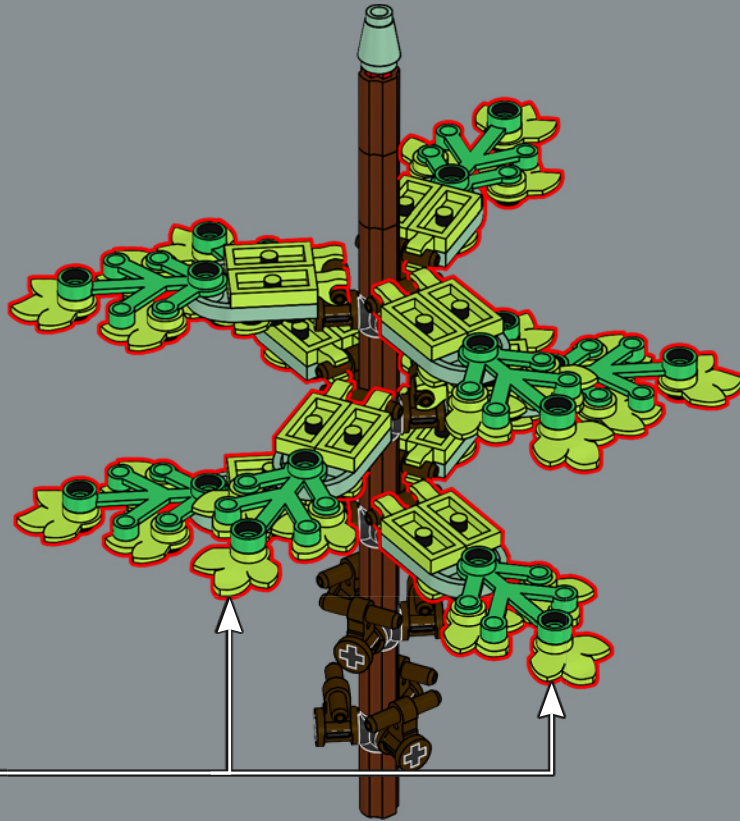
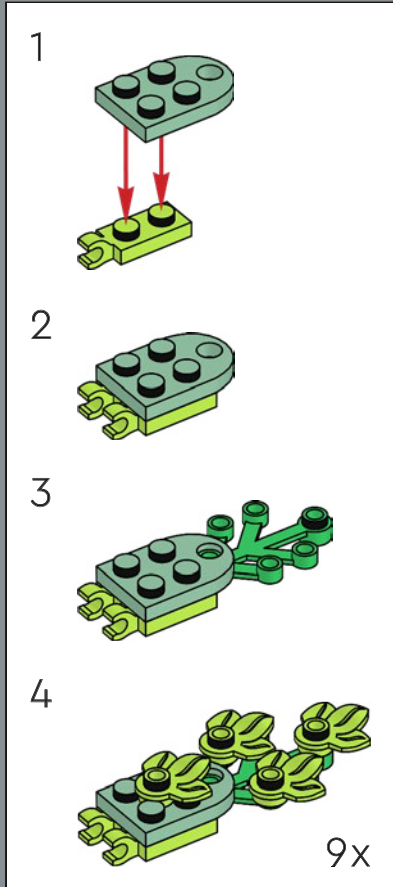

306

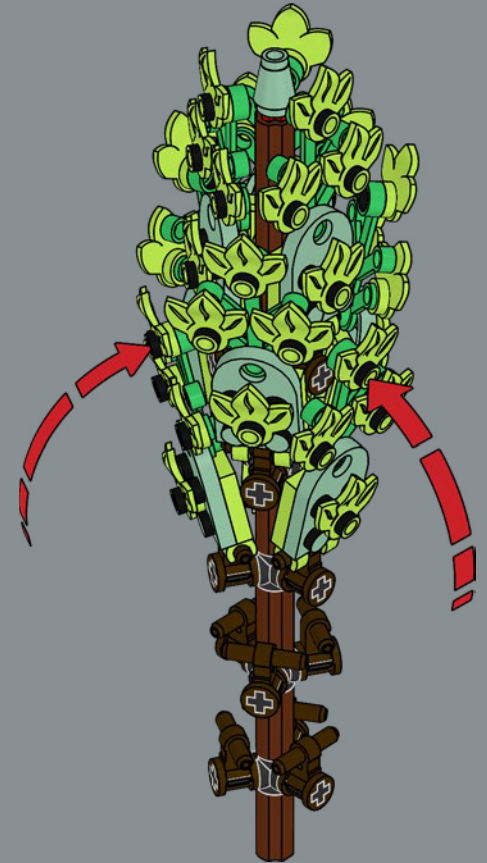

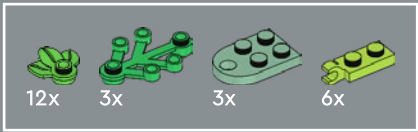

307

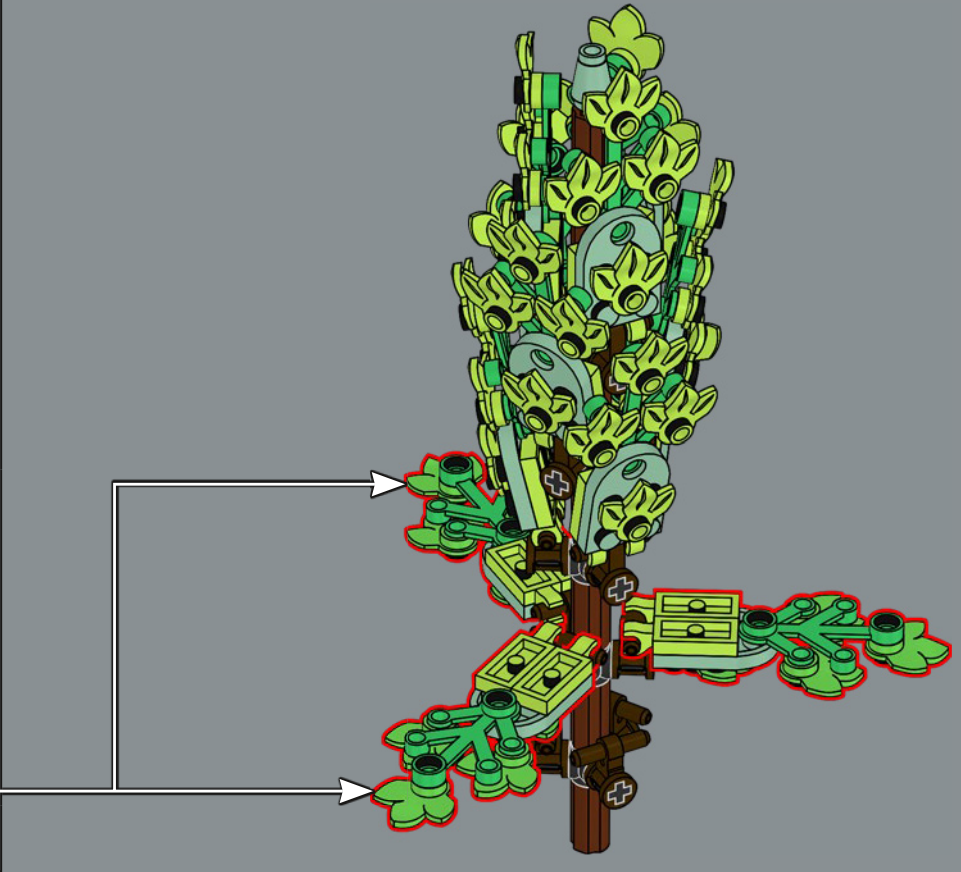
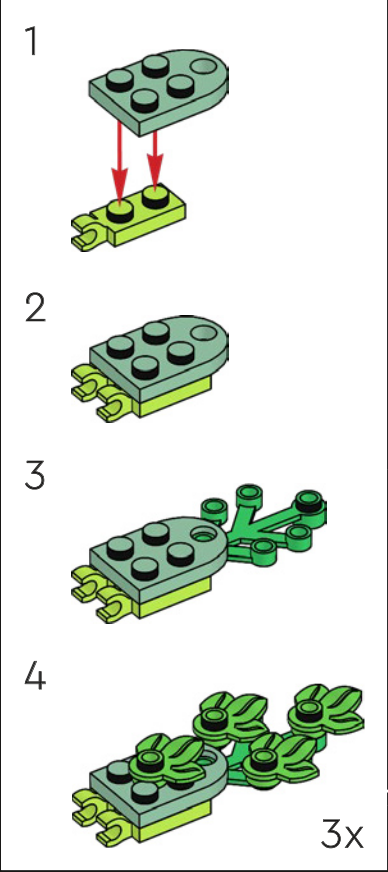

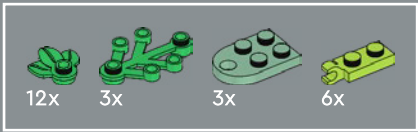

308

1

2

3

4

3x

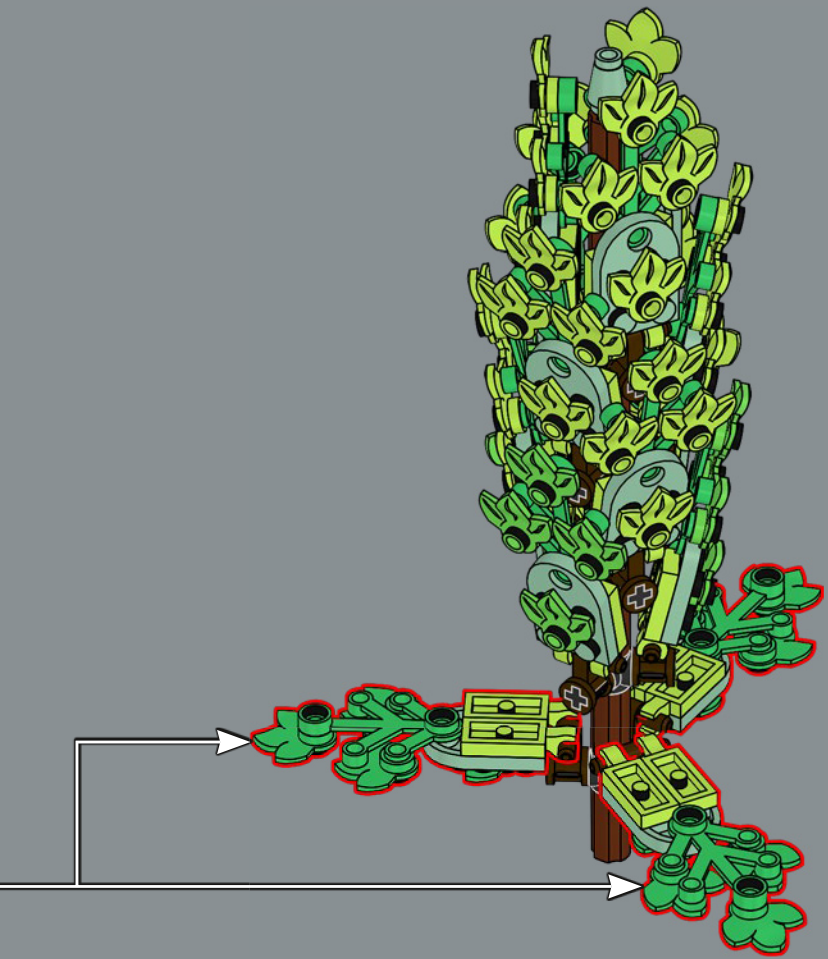



309

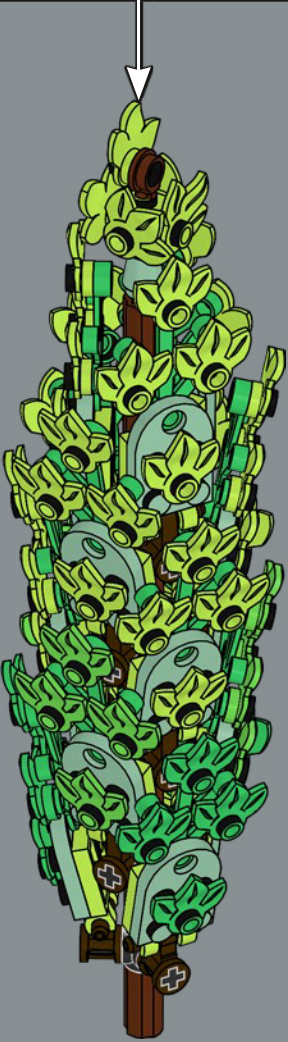
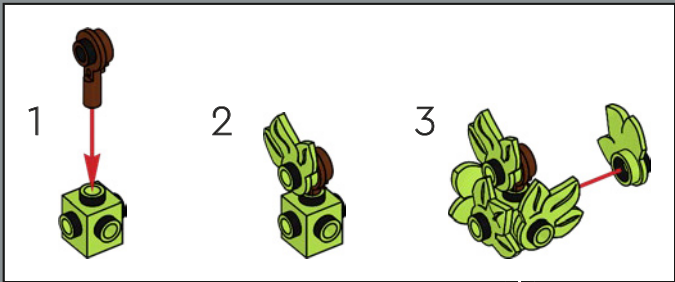

310



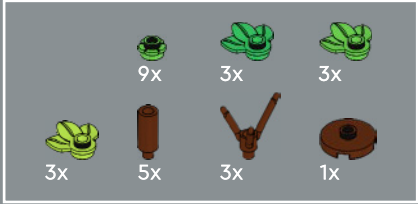
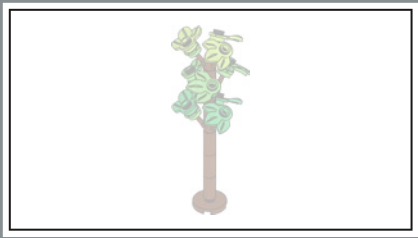

311

1



2

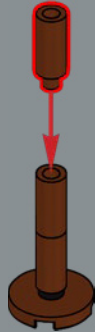

3

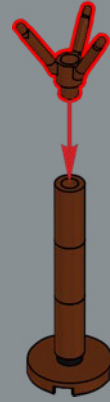

4



5

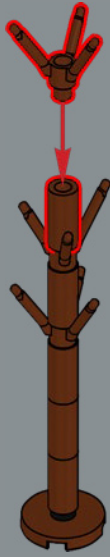

6

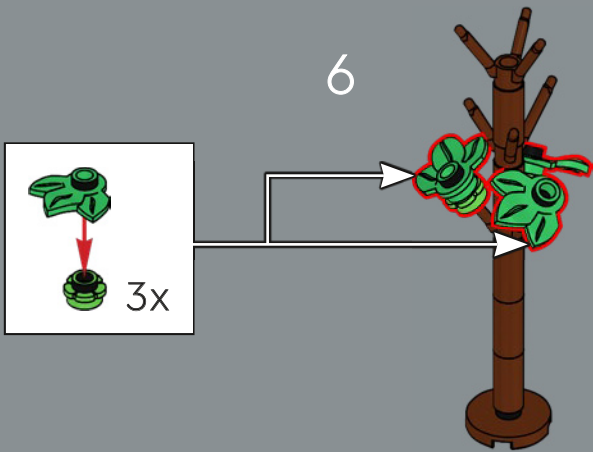

7

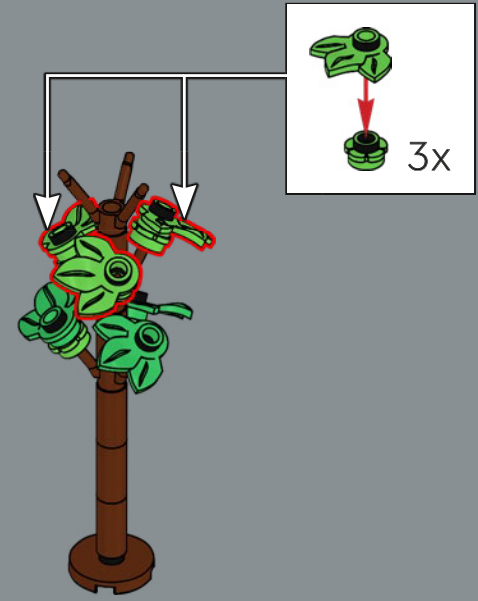

8

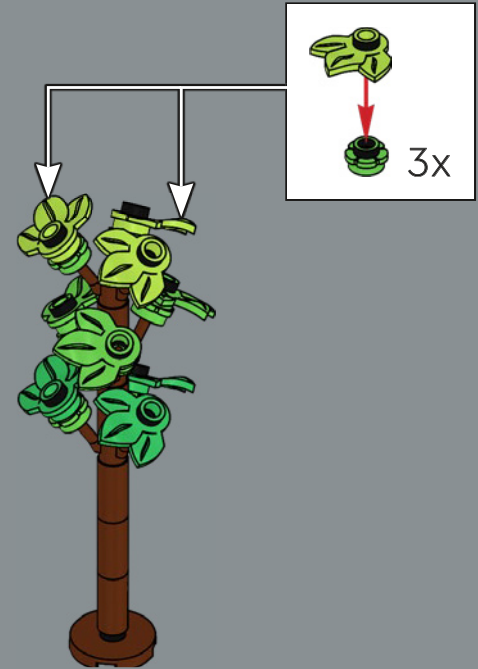



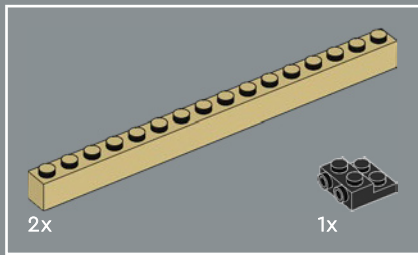

312

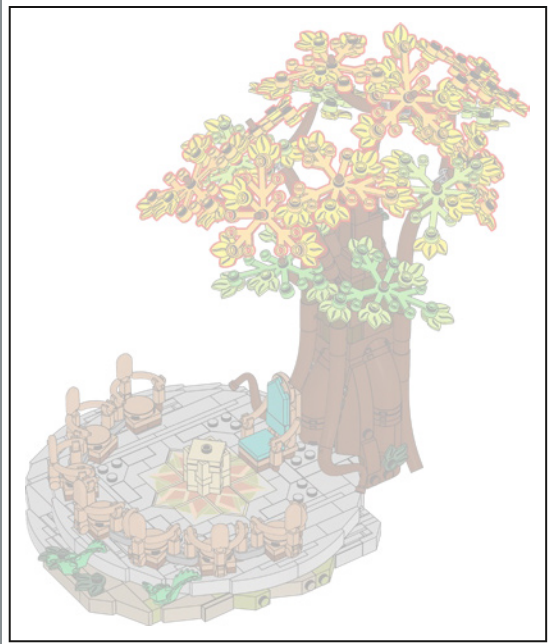
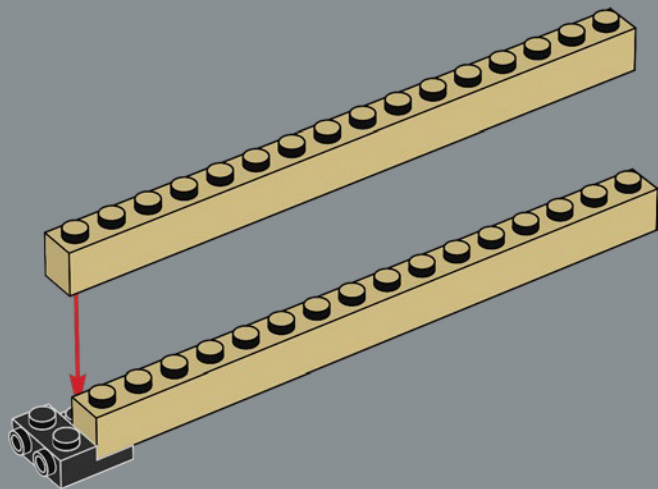

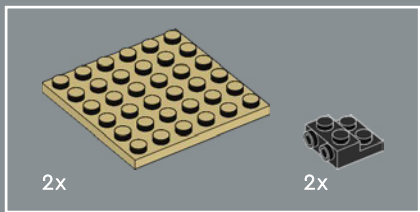

313

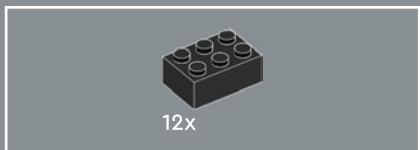
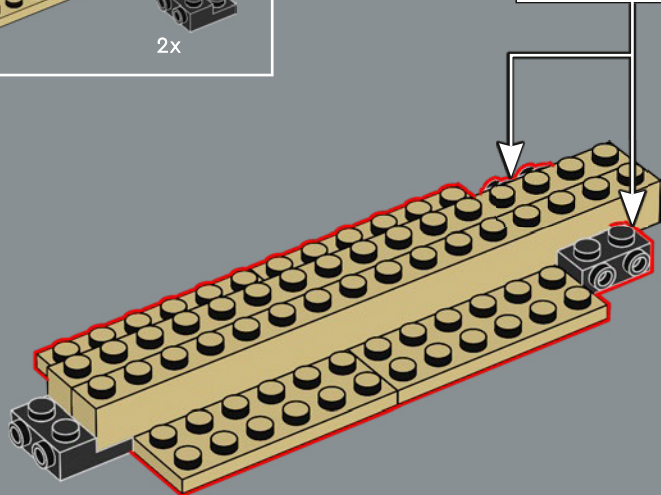

314

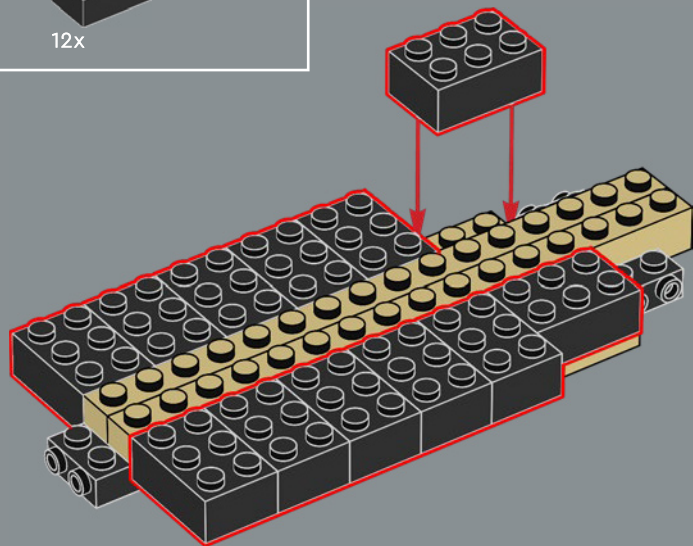

315

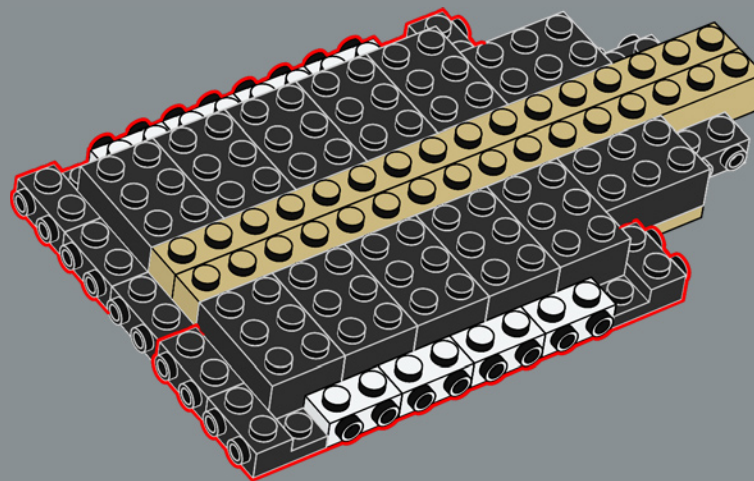

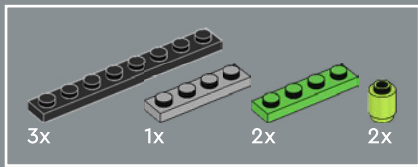

316

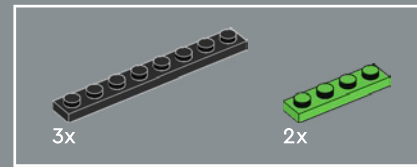
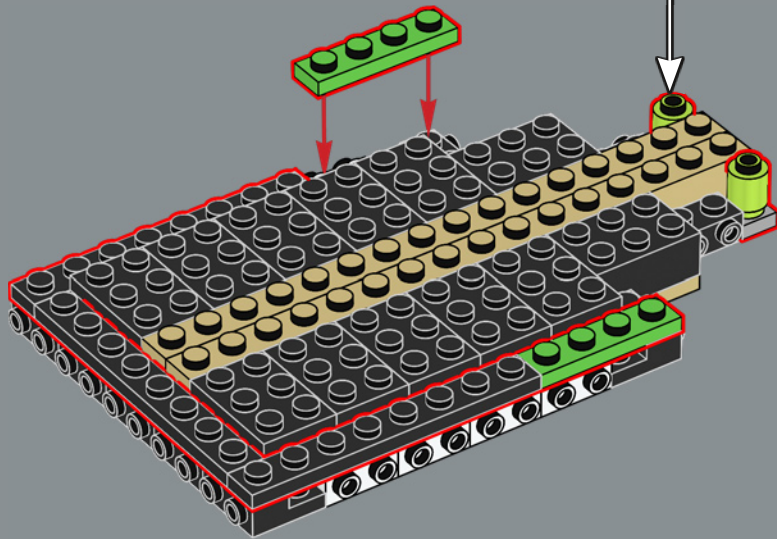
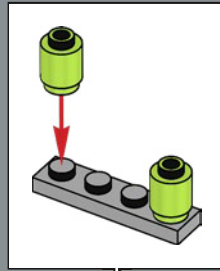

317

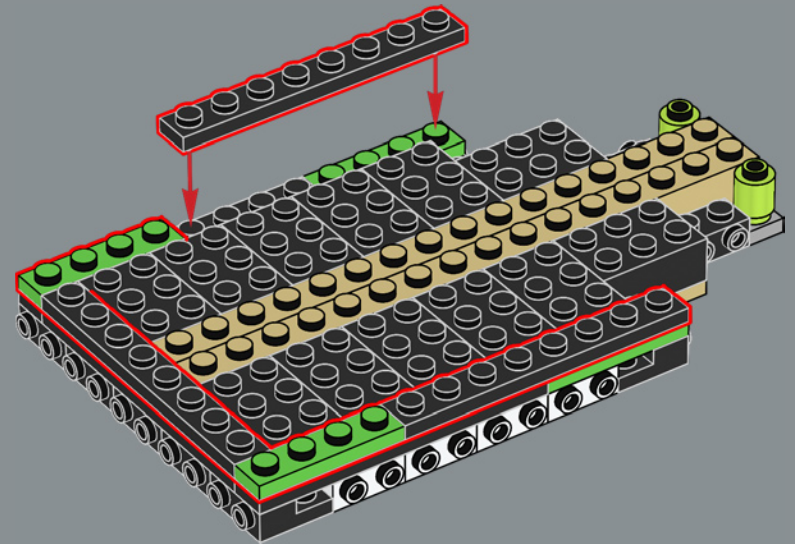

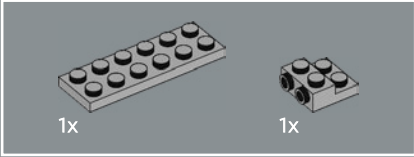
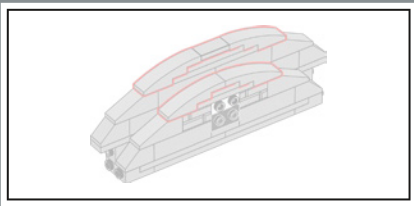

318

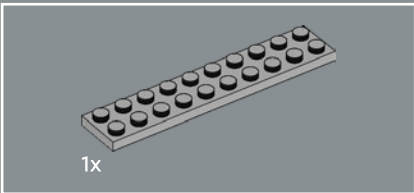
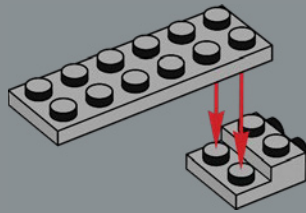

319

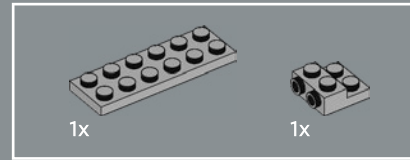
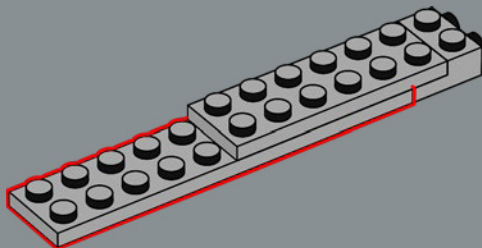

320

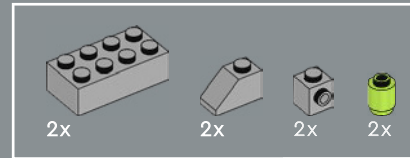
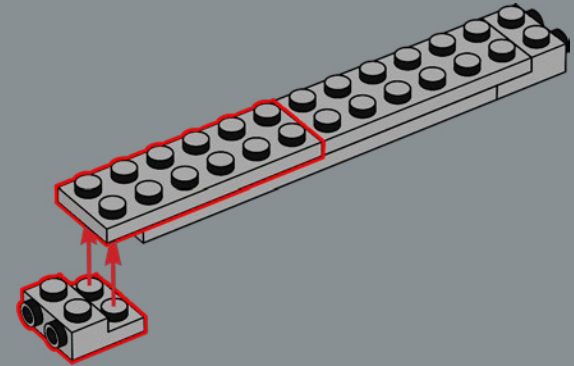

321

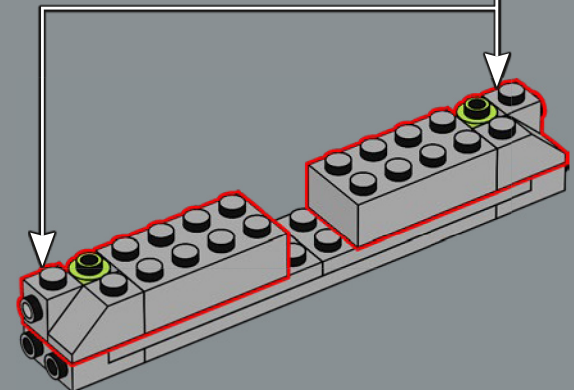
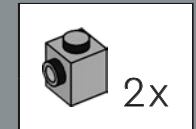

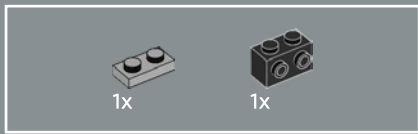

322

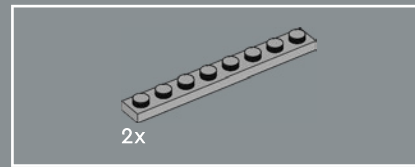
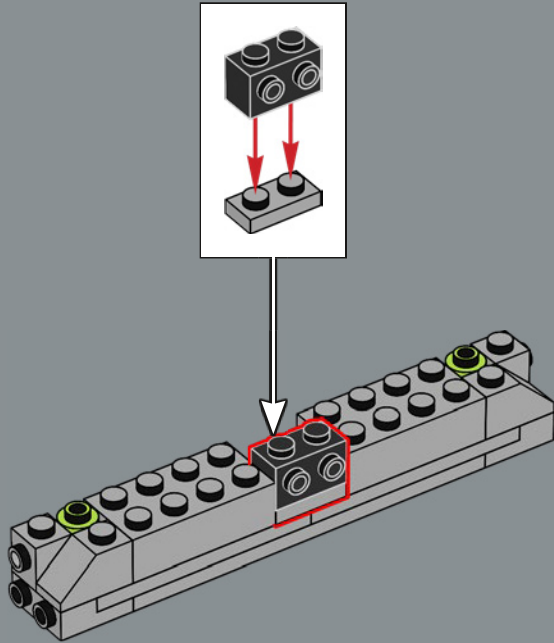

323

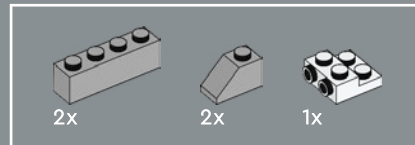
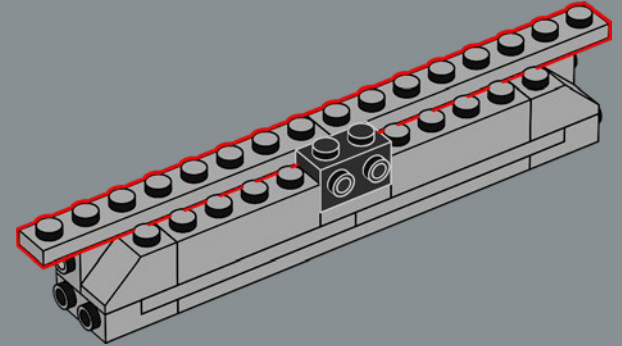

324

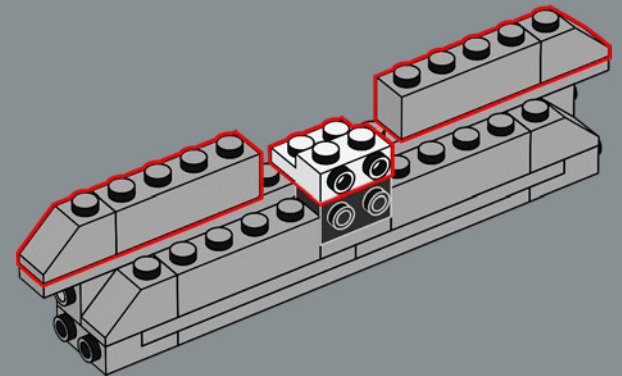

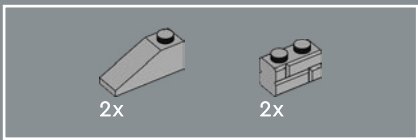

325

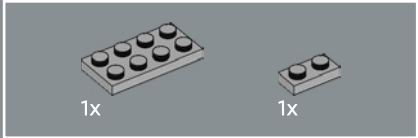
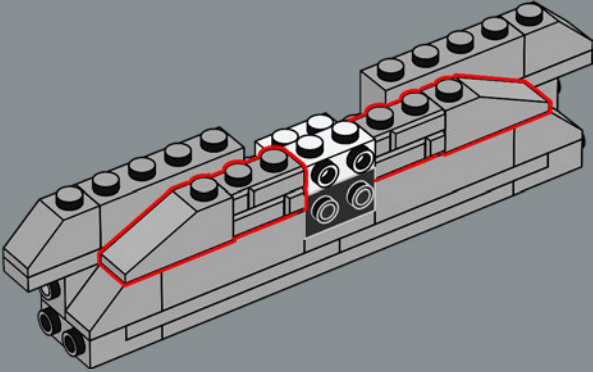

326

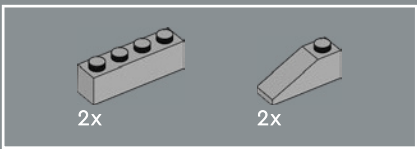
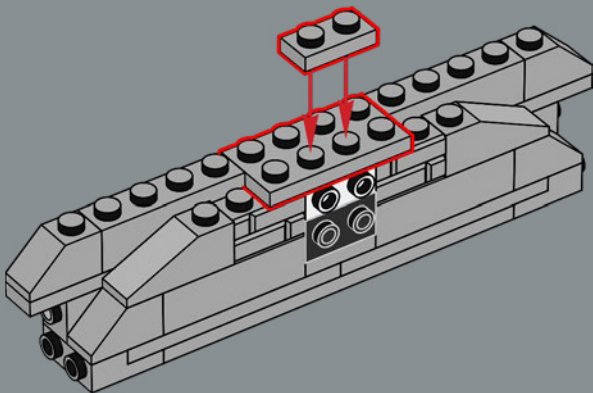

327

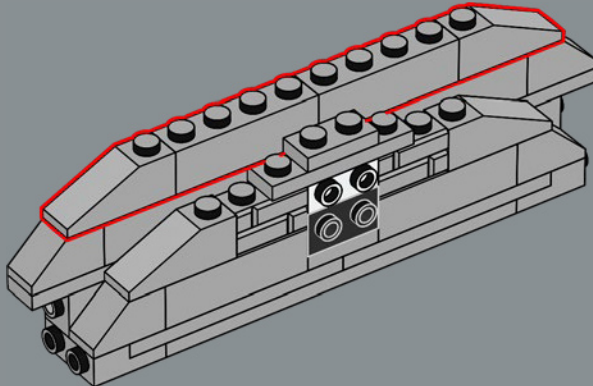



Dieser Sockel ist mit kräftigen seitlichen Riegeln versehen, damit sich das gesamte Ratssegment vom Modell abnehmen und einzeln ausstellen lässt.

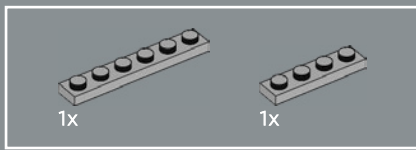

328

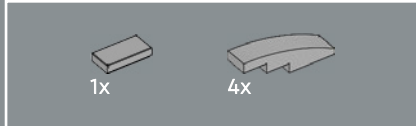
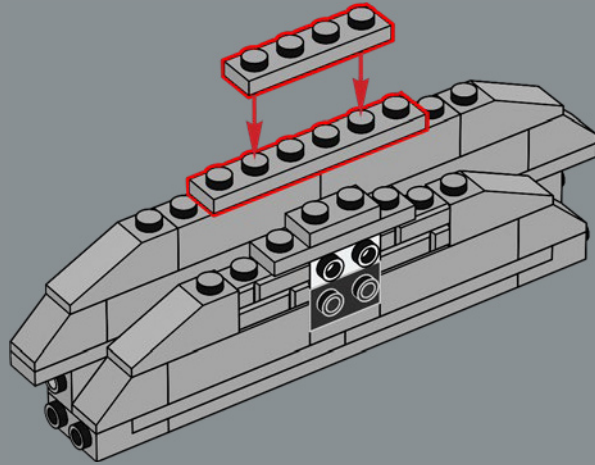

329

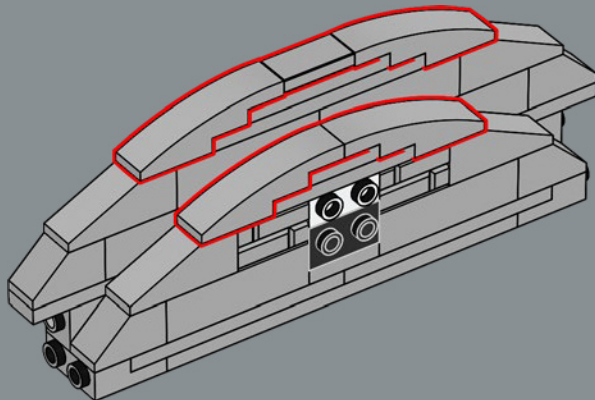

330

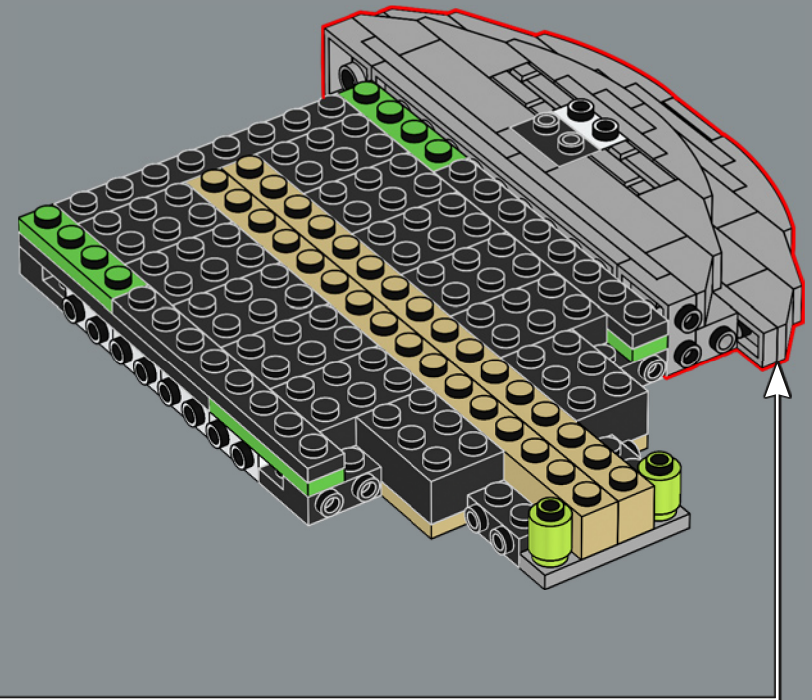

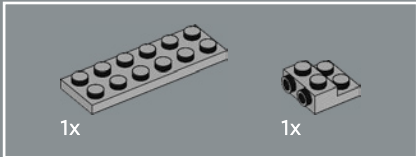
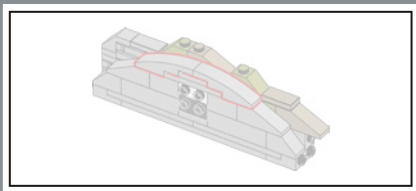

331

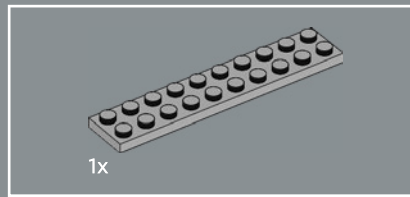
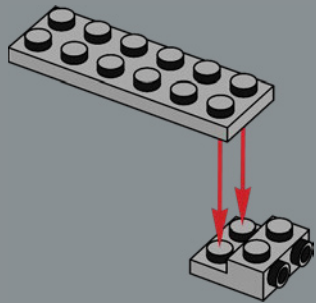

332

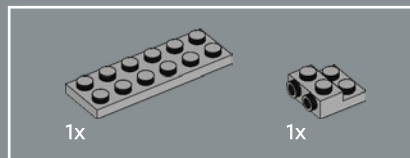
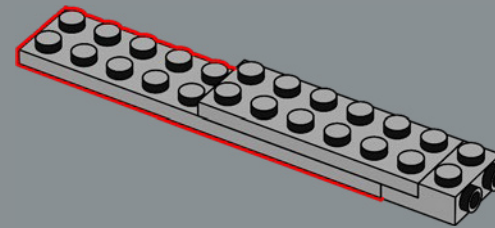

333

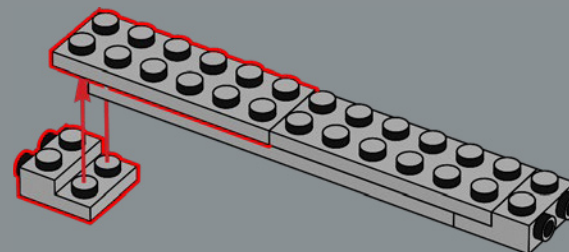

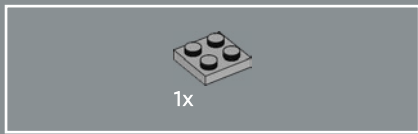

334

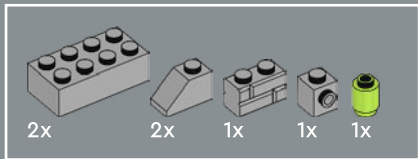
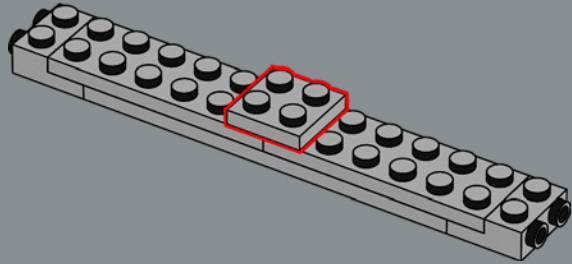

335

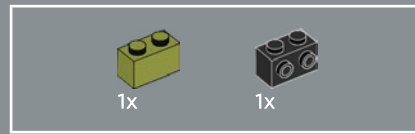
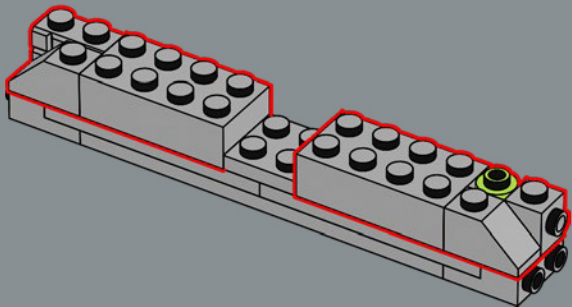

336

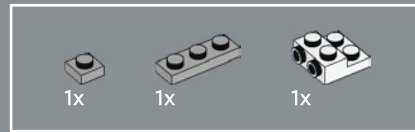
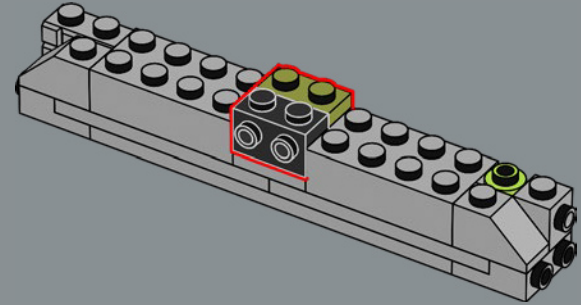

337

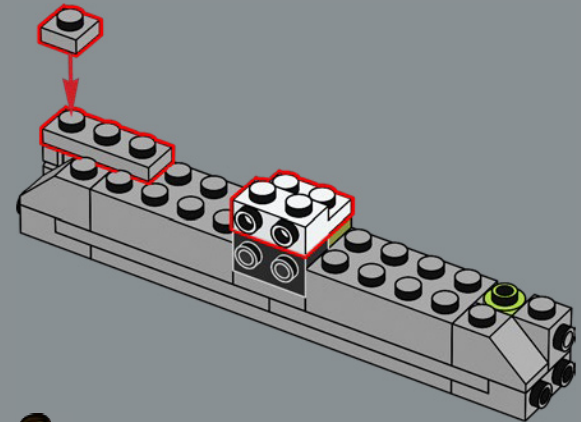

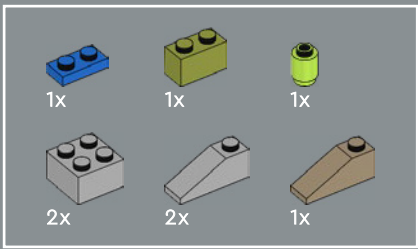

338

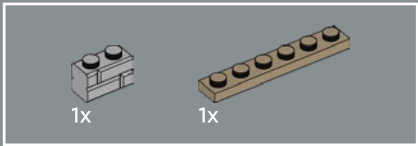
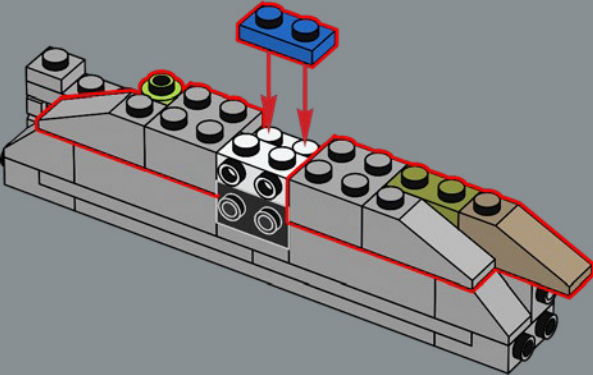

339

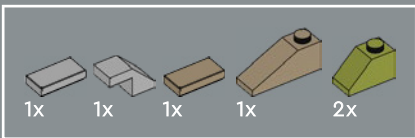
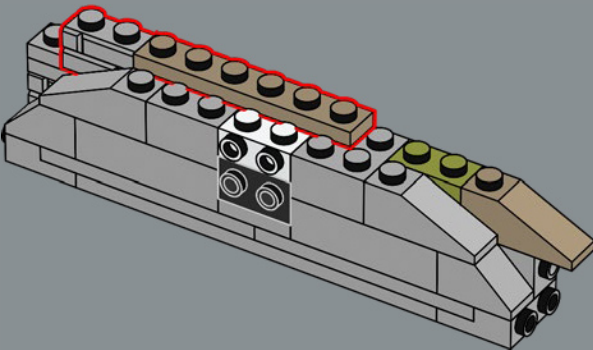

340

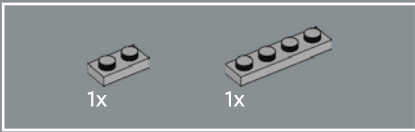
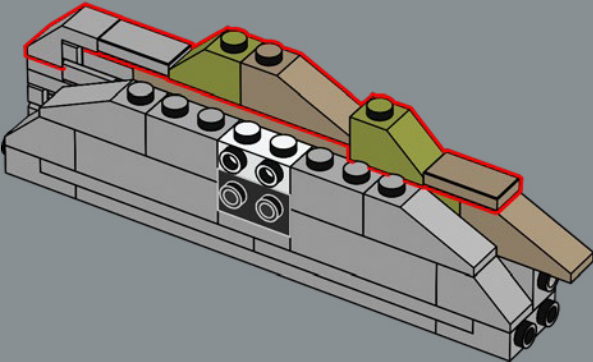

341

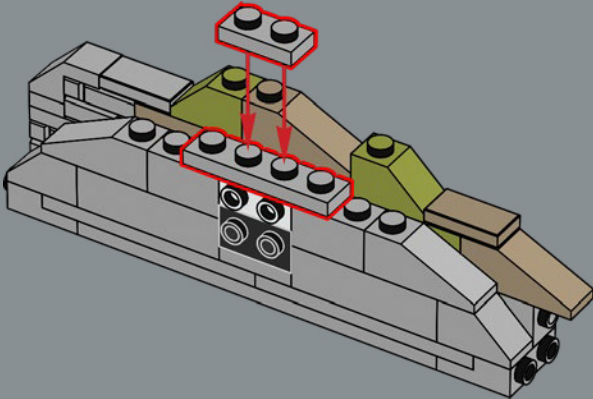

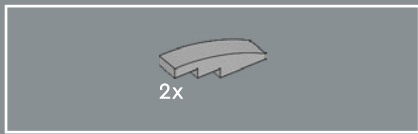

342

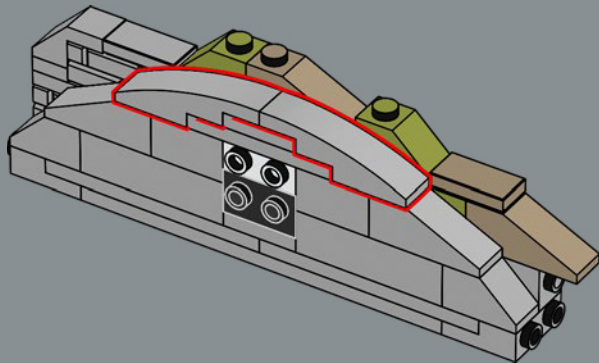

343

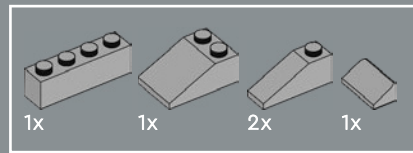
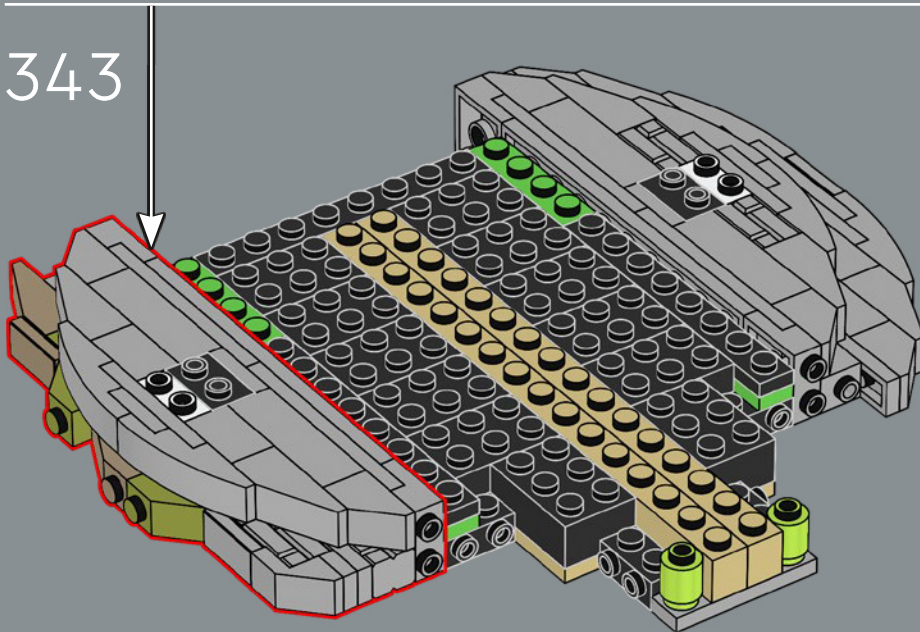

344

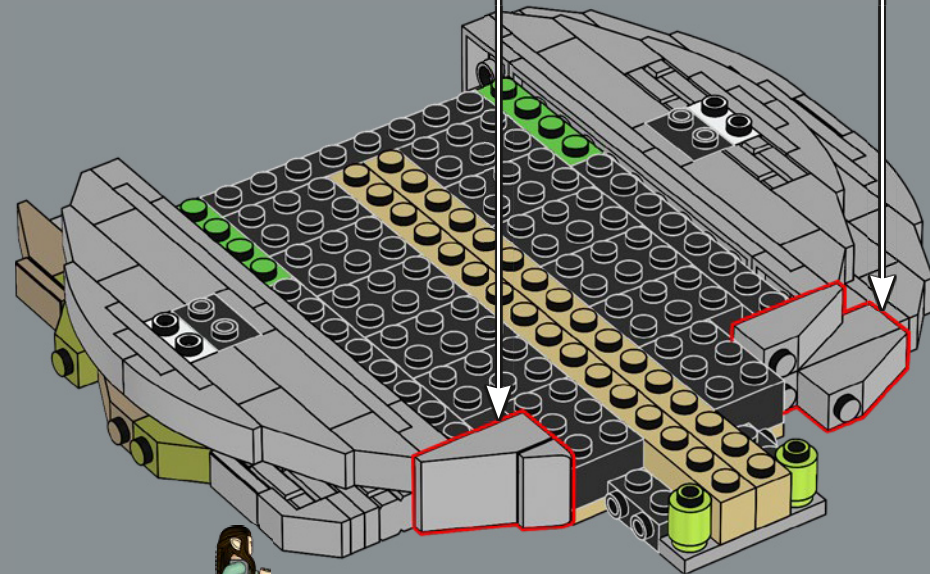
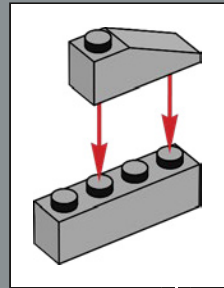
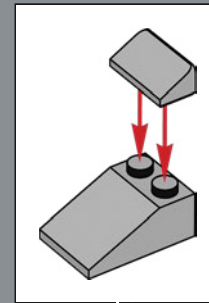

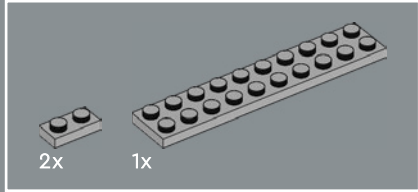
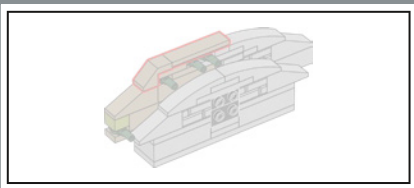

345

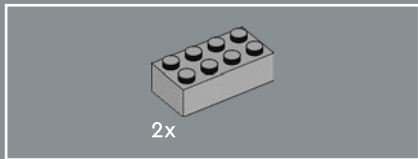
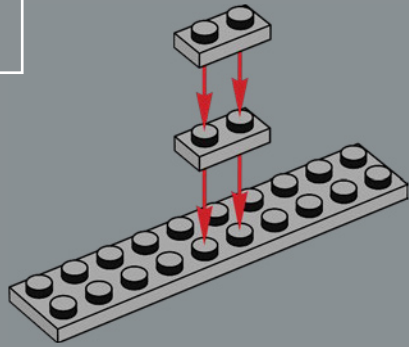

346

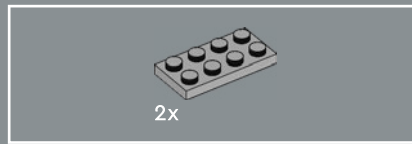
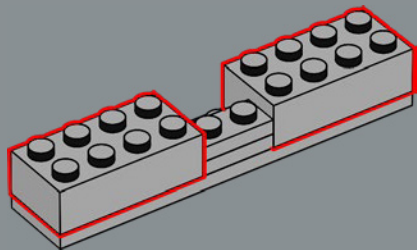

347

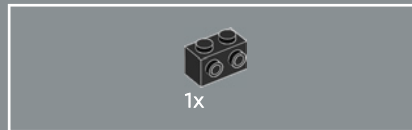
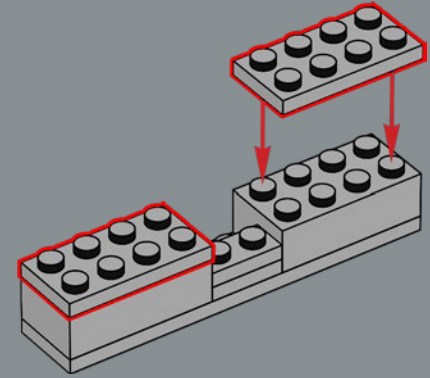

348

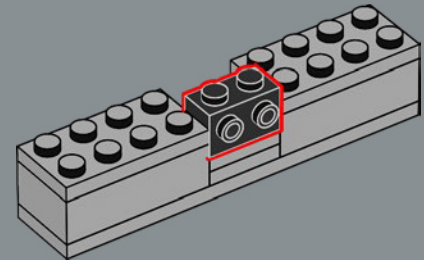

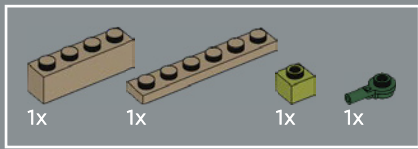

349

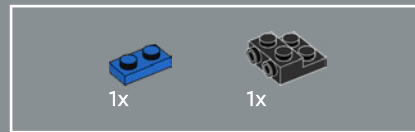
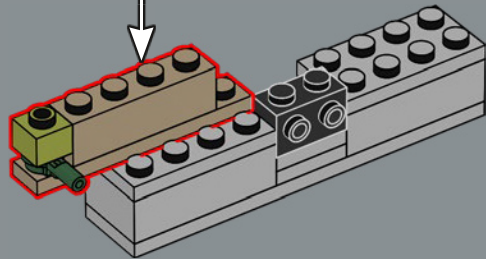
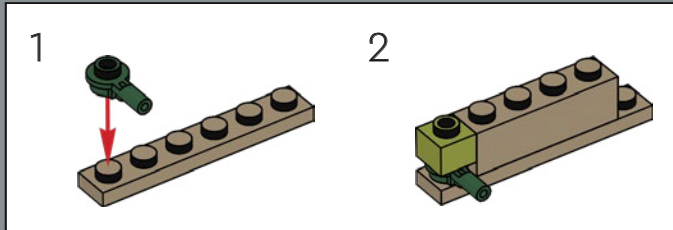

350

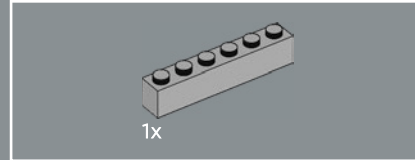
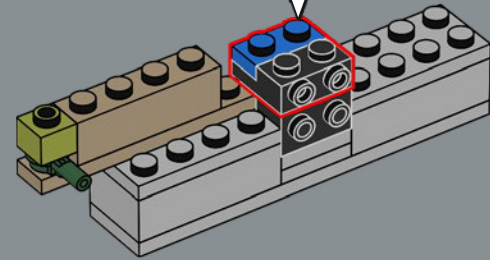
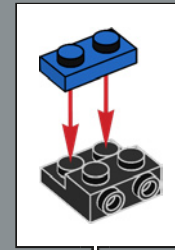

351

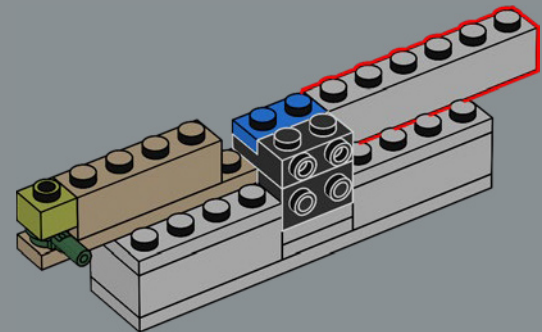

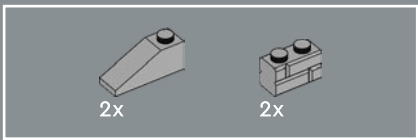

352

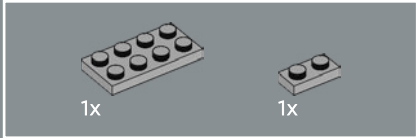
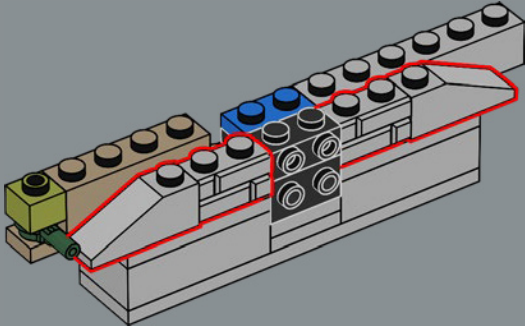

353

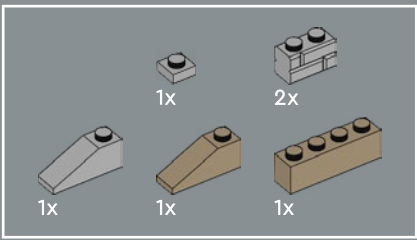
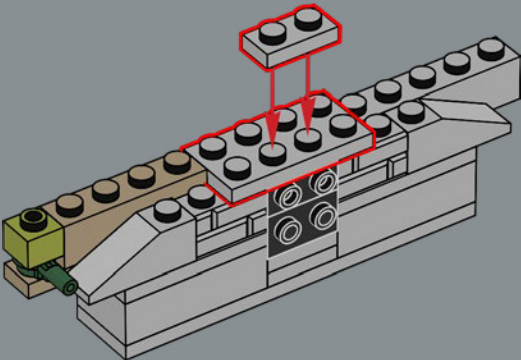

354

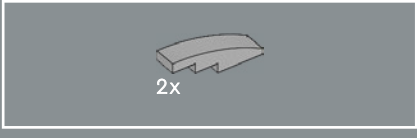
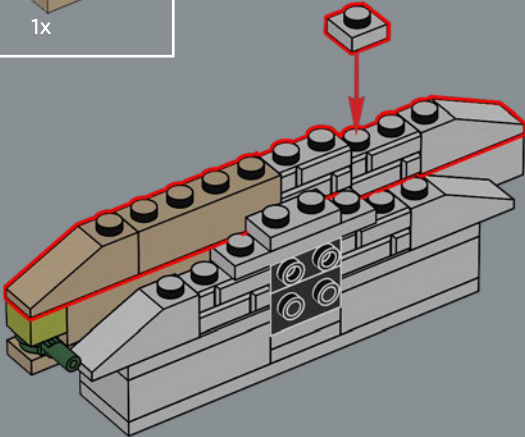

355

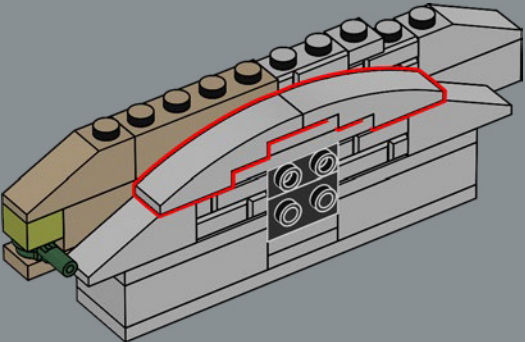

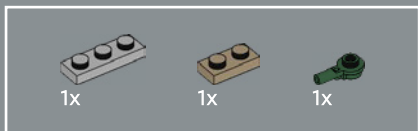

356

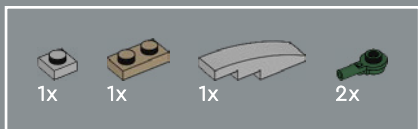
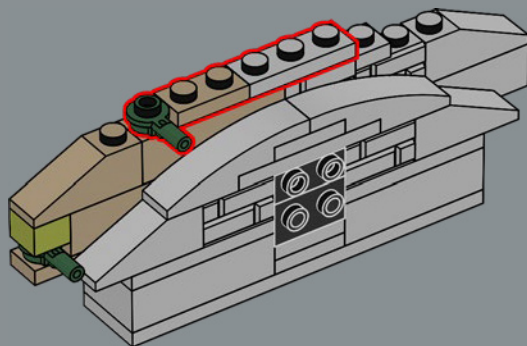

357

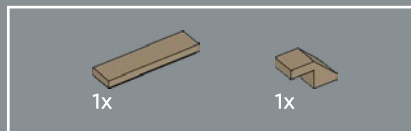
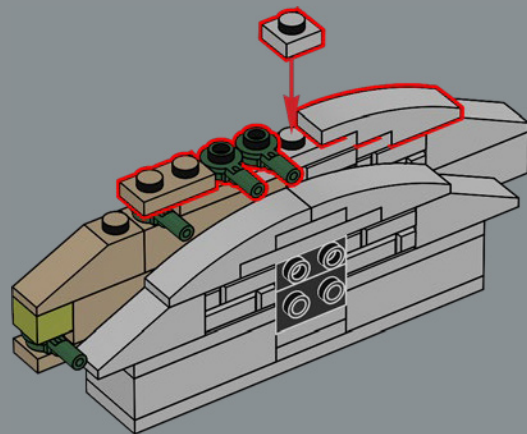

358

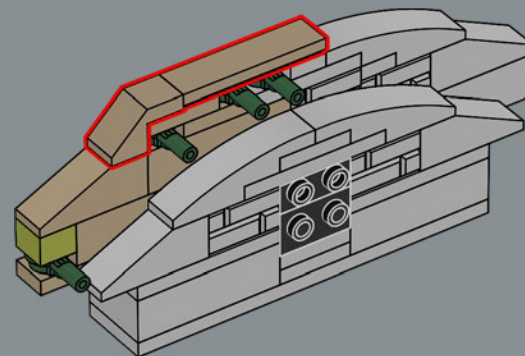

359

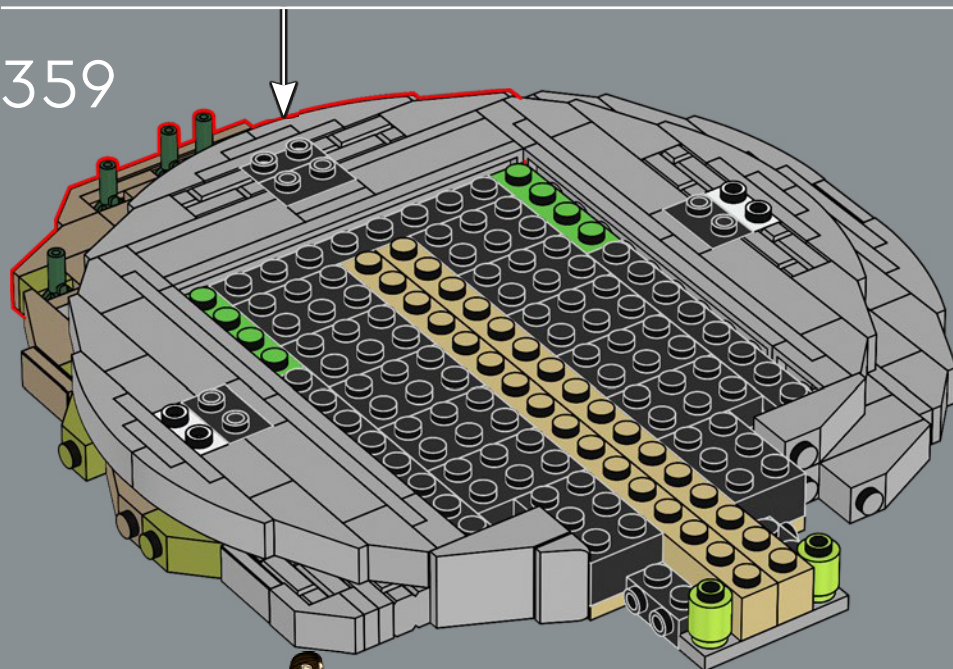



360

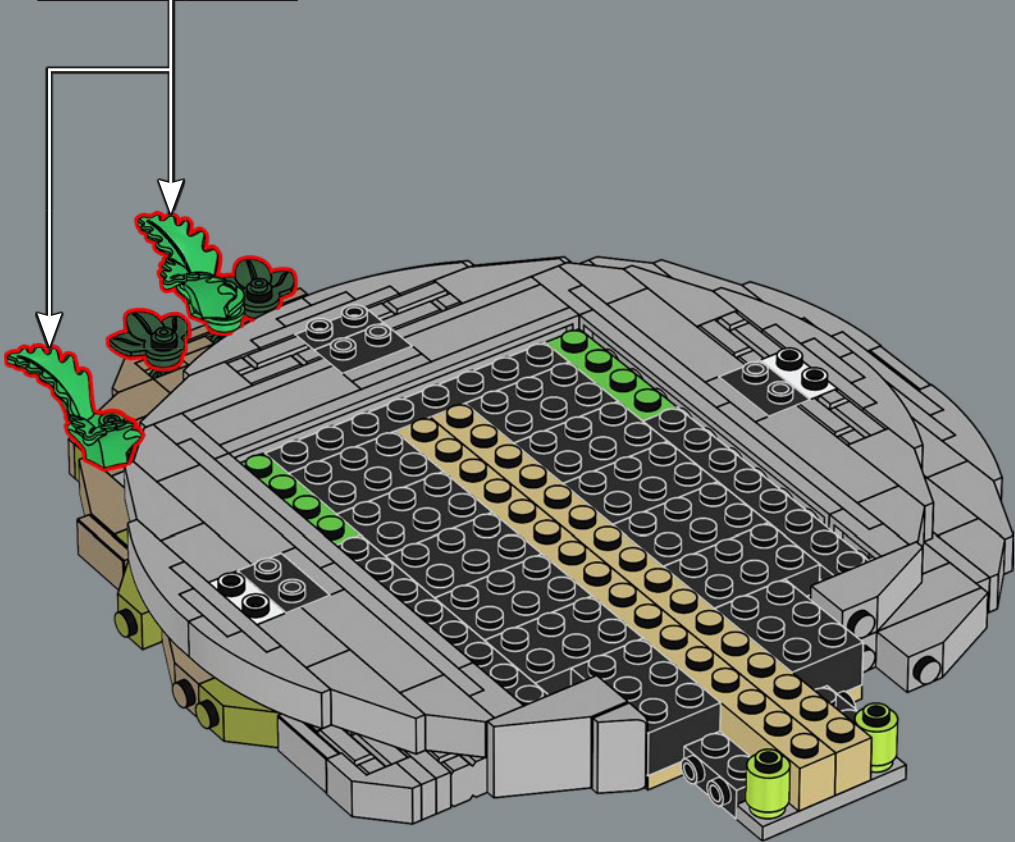
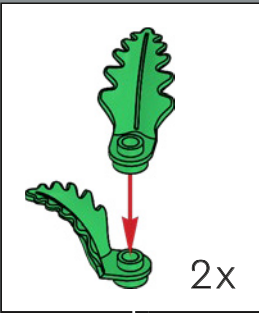

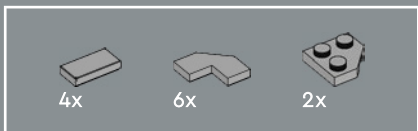

361

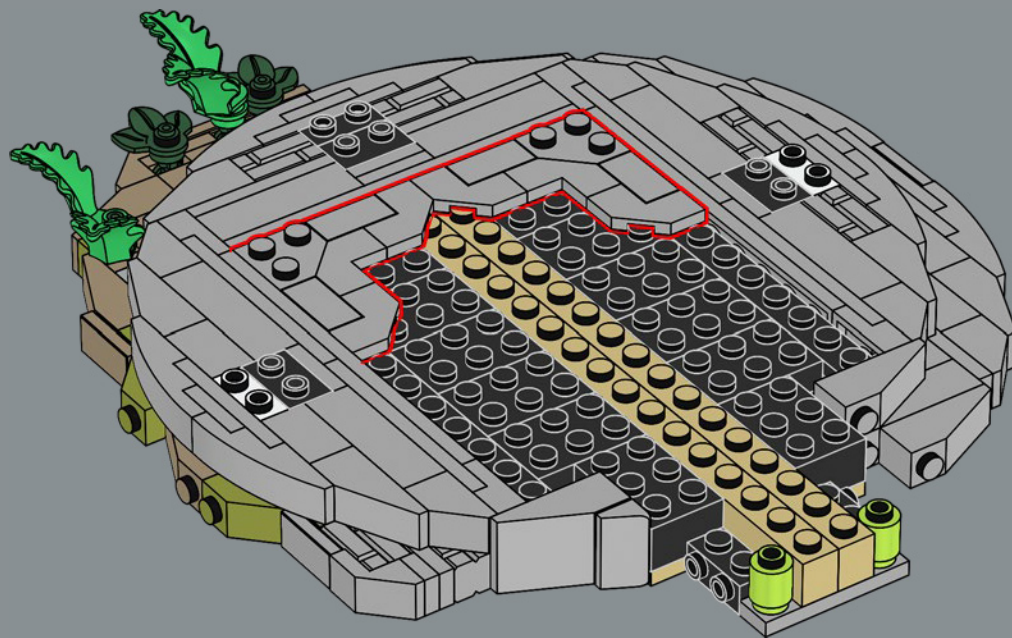

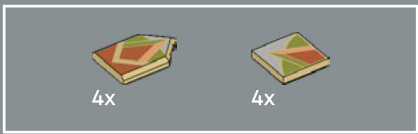

362

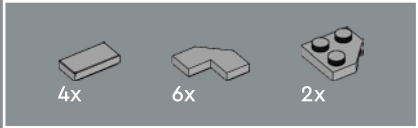
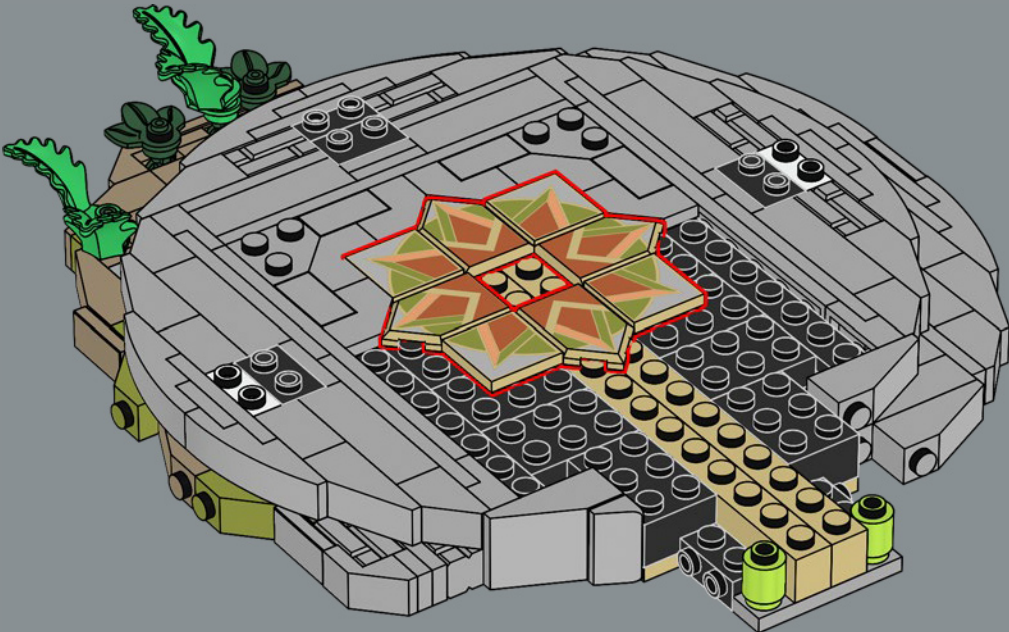

363

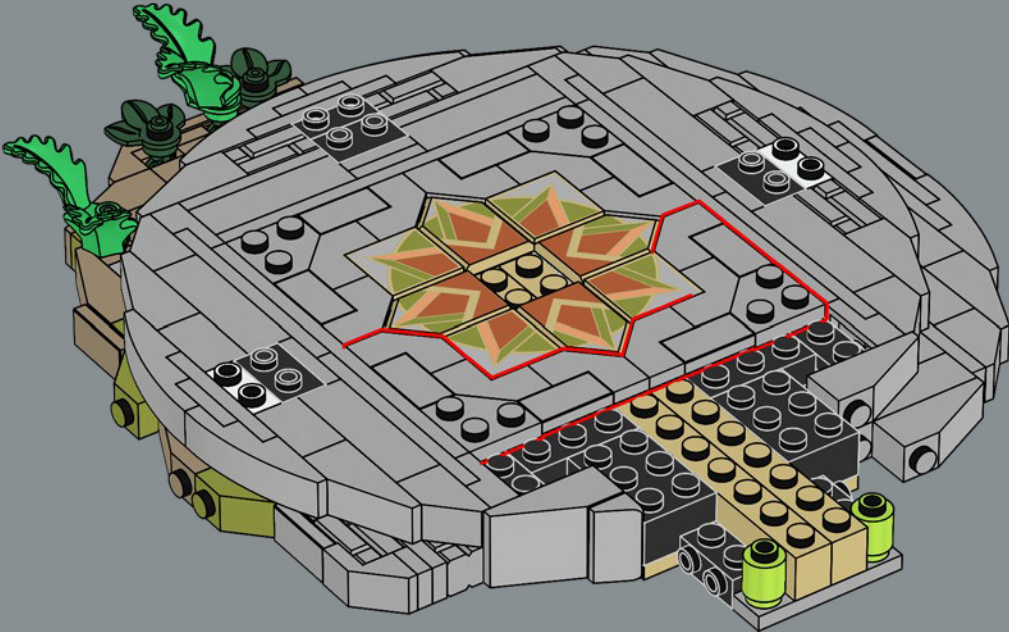

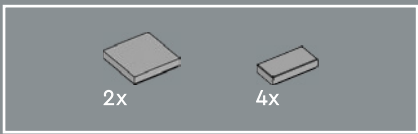

364

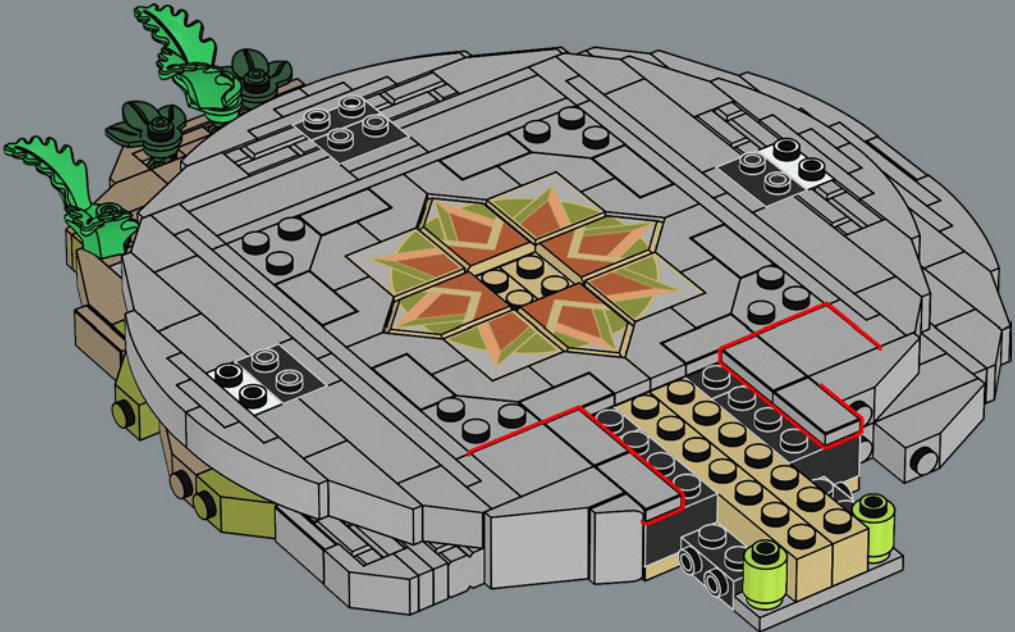

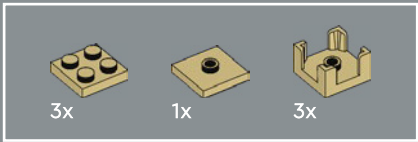

365

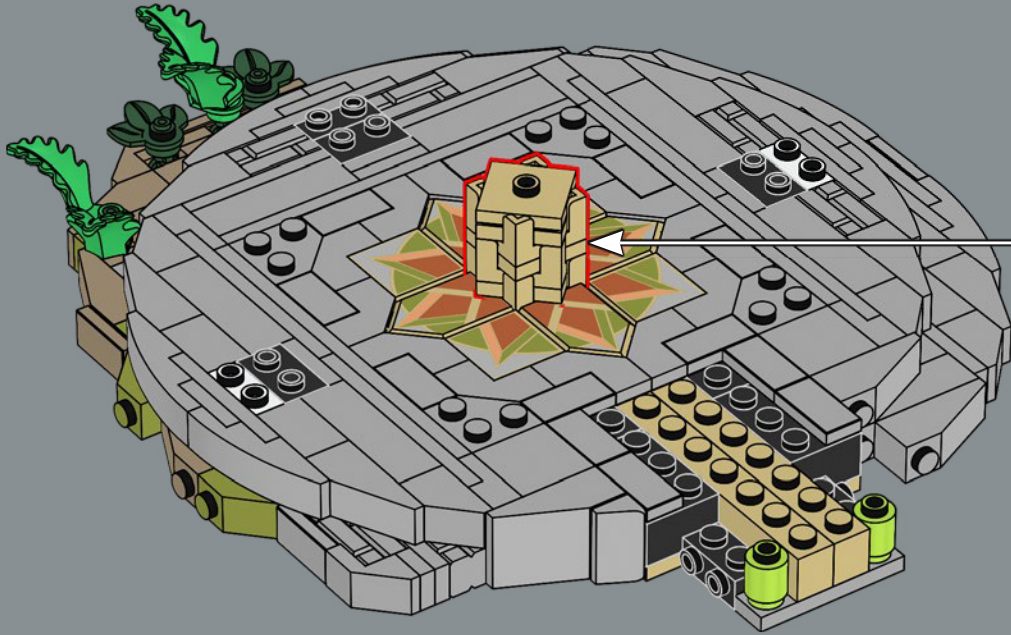
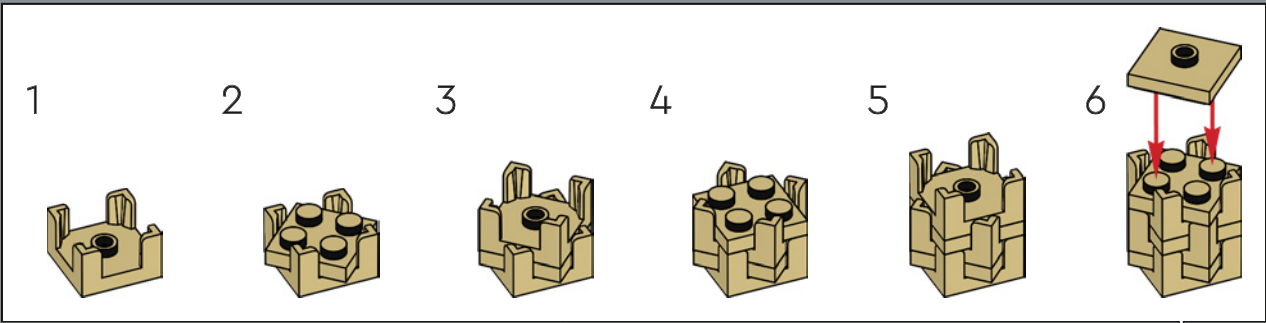

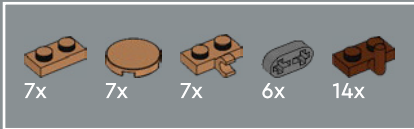
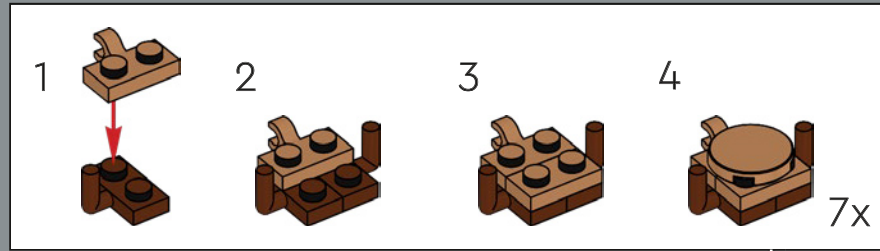
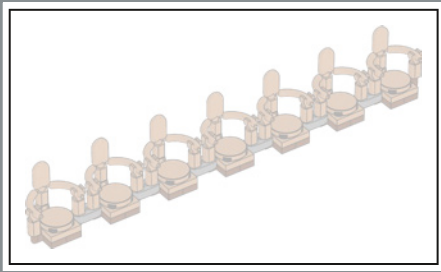

366

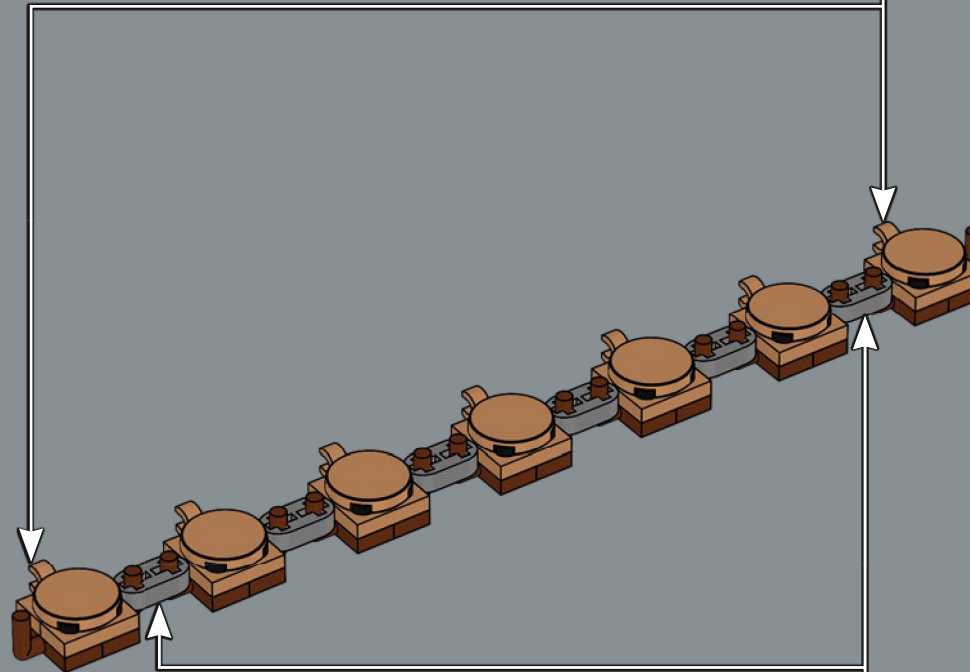



14x

367

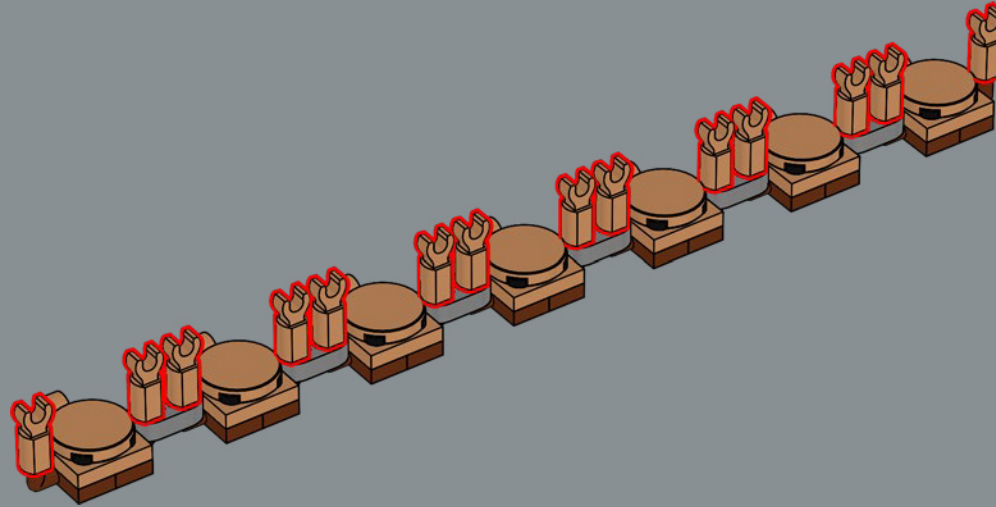

14x

368

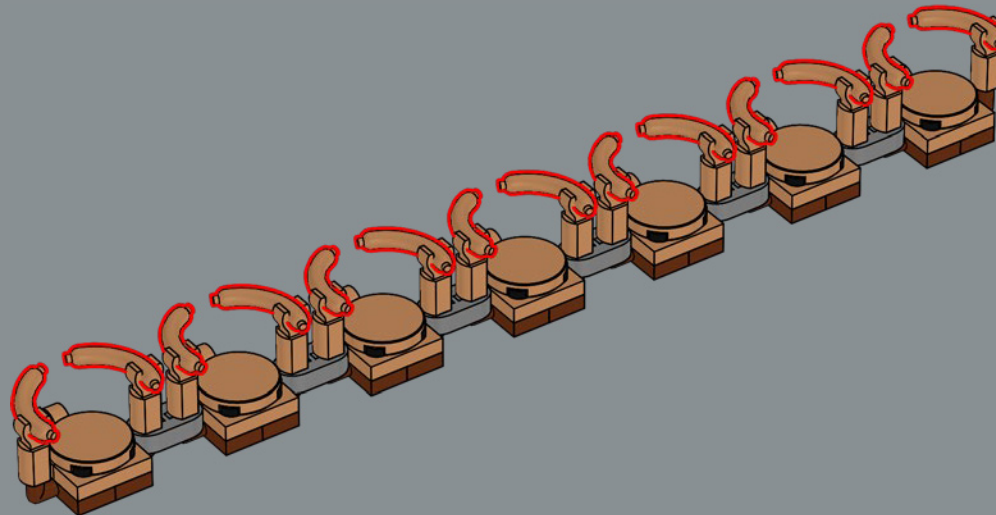

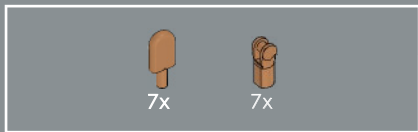

369

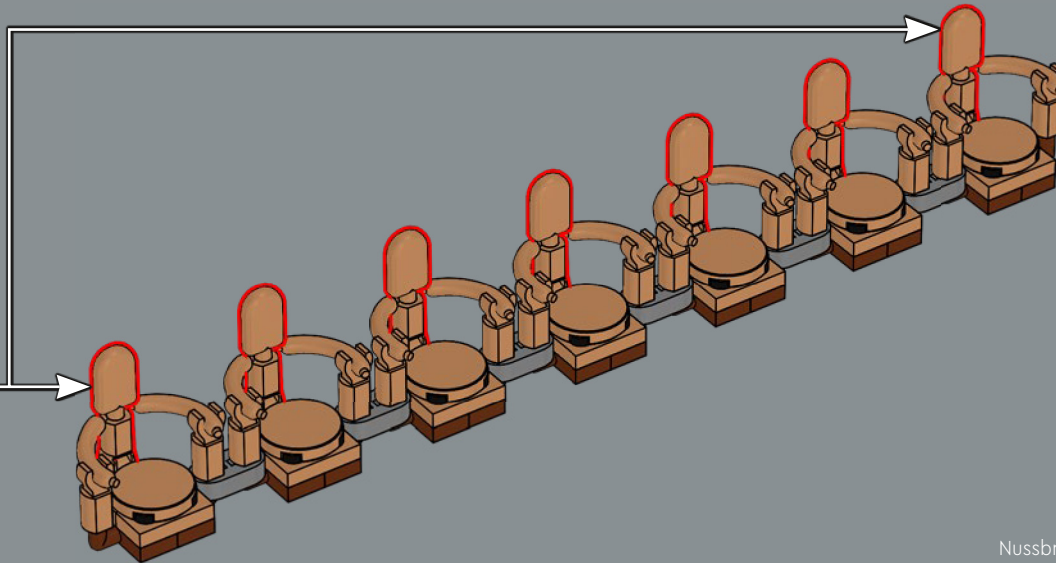
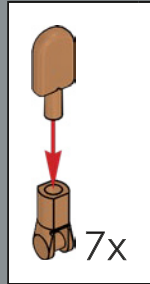

Nussbraune Stühle aus Hotdogs und Eis am Stiel:
An dem Tag waren wir wohl hungrig ...

370

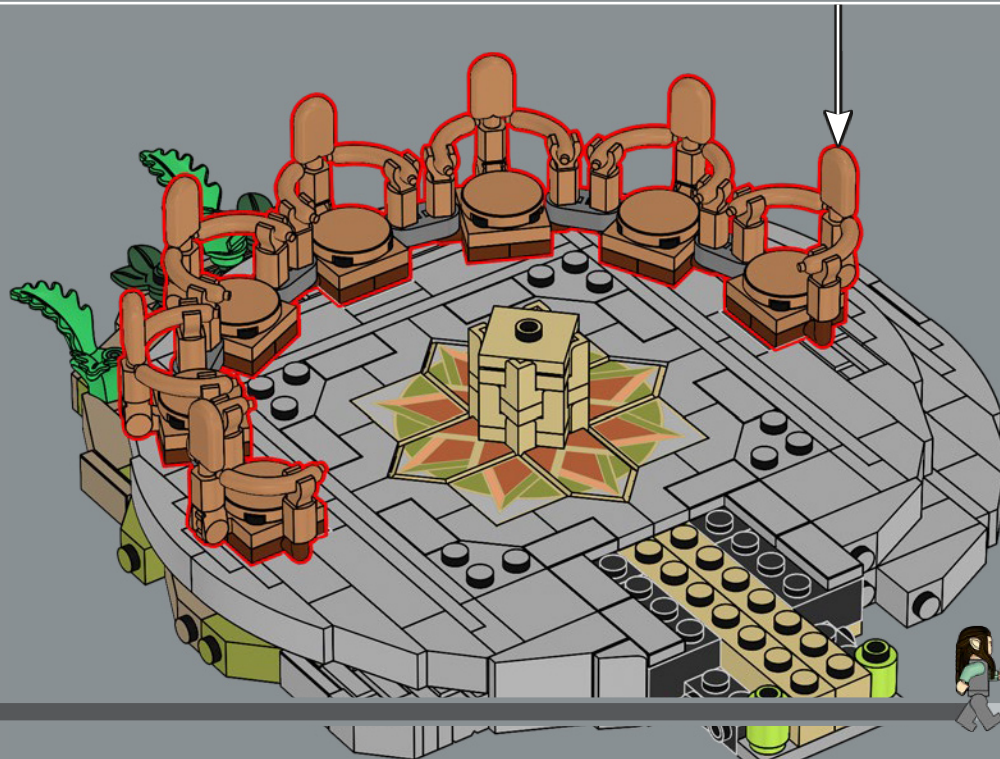

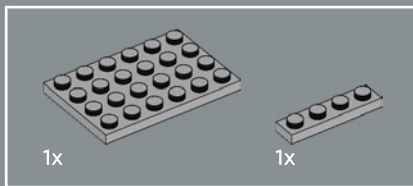

371

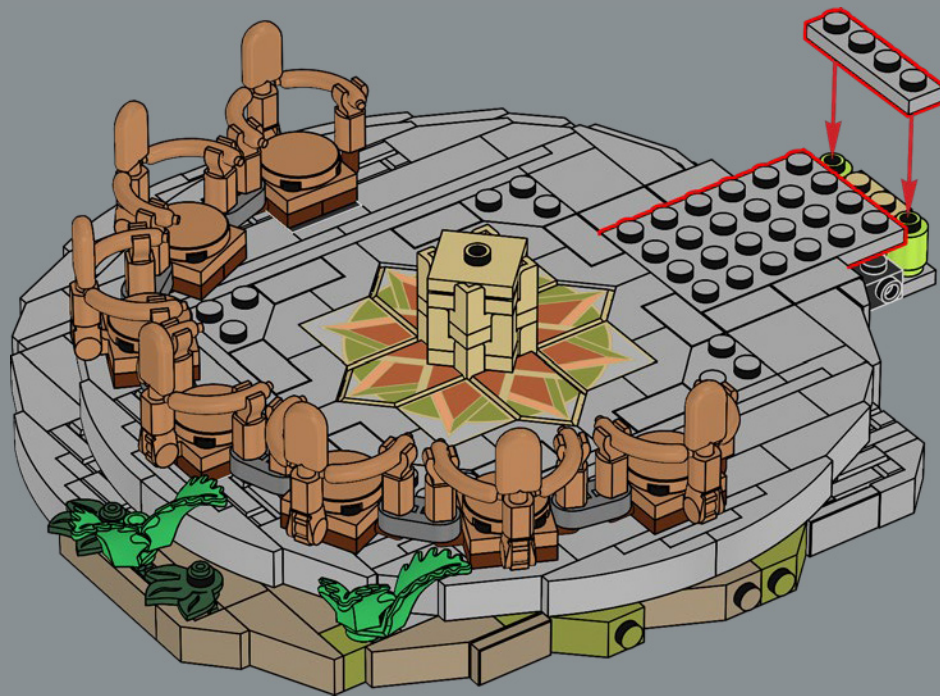
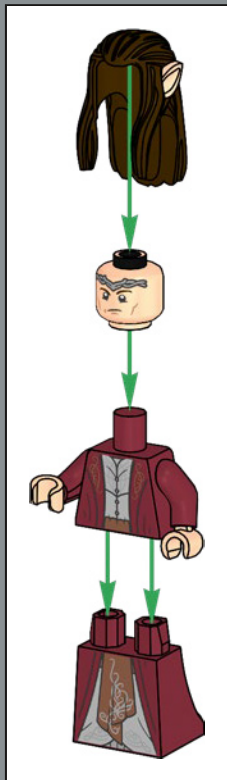

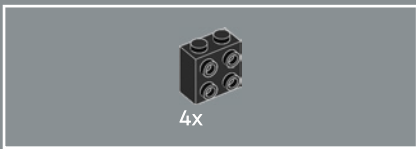

372

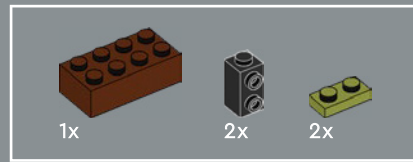
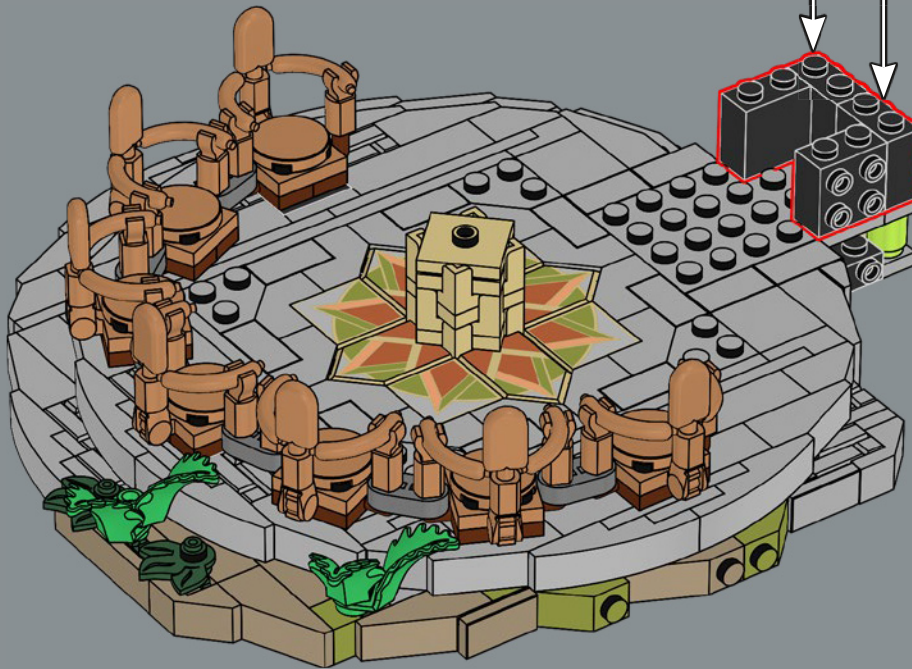
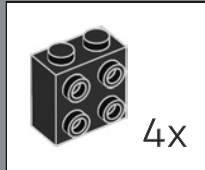

373

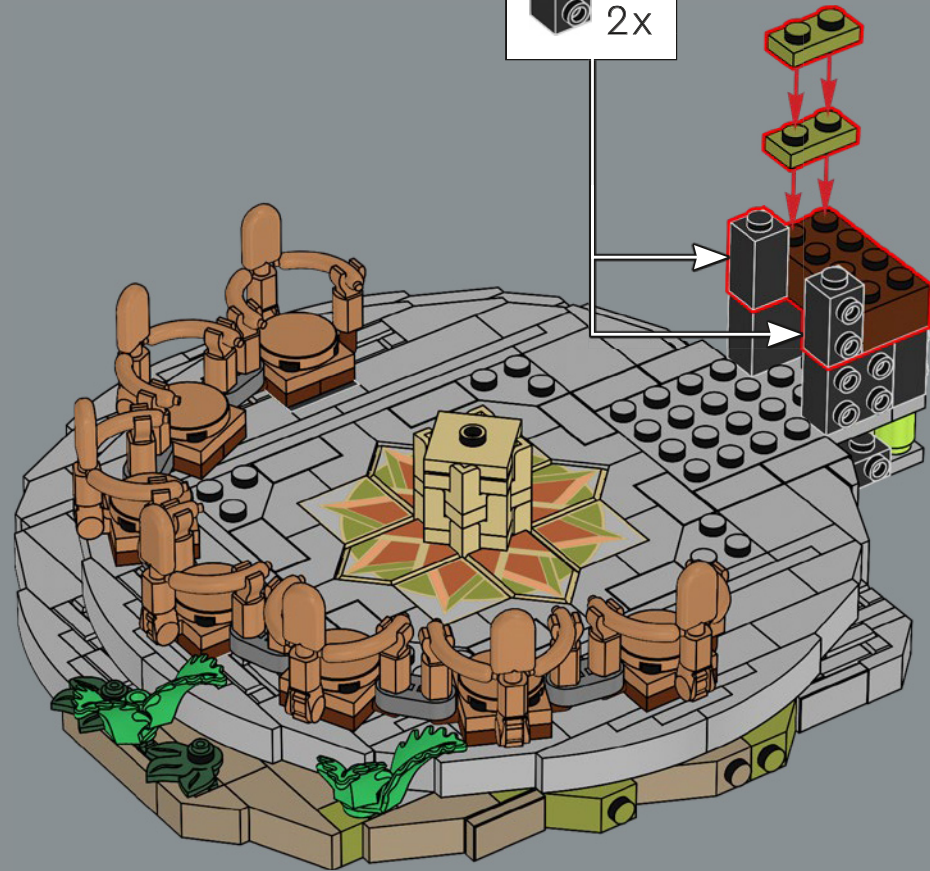
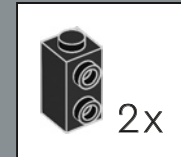

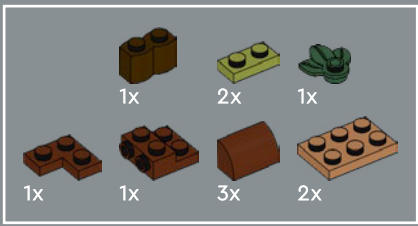

374

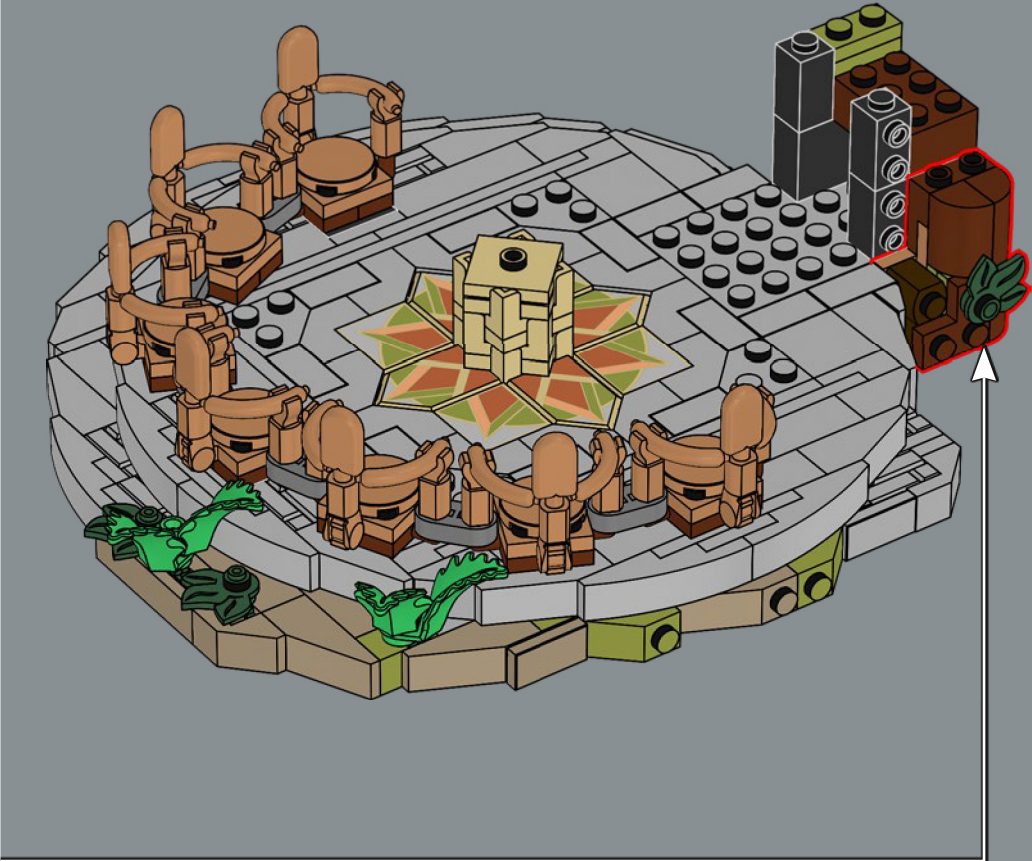
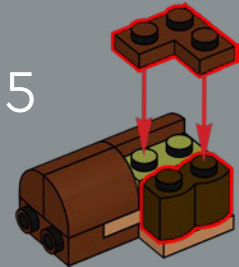
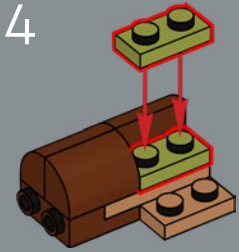
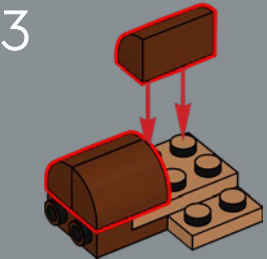
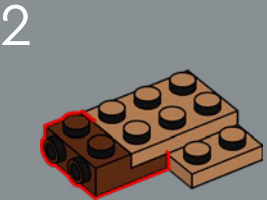
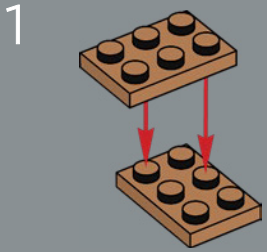



375

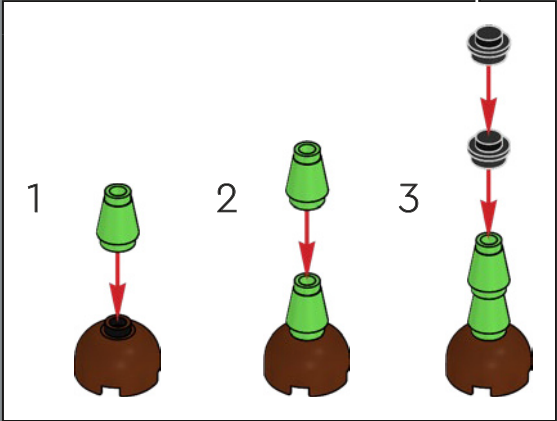
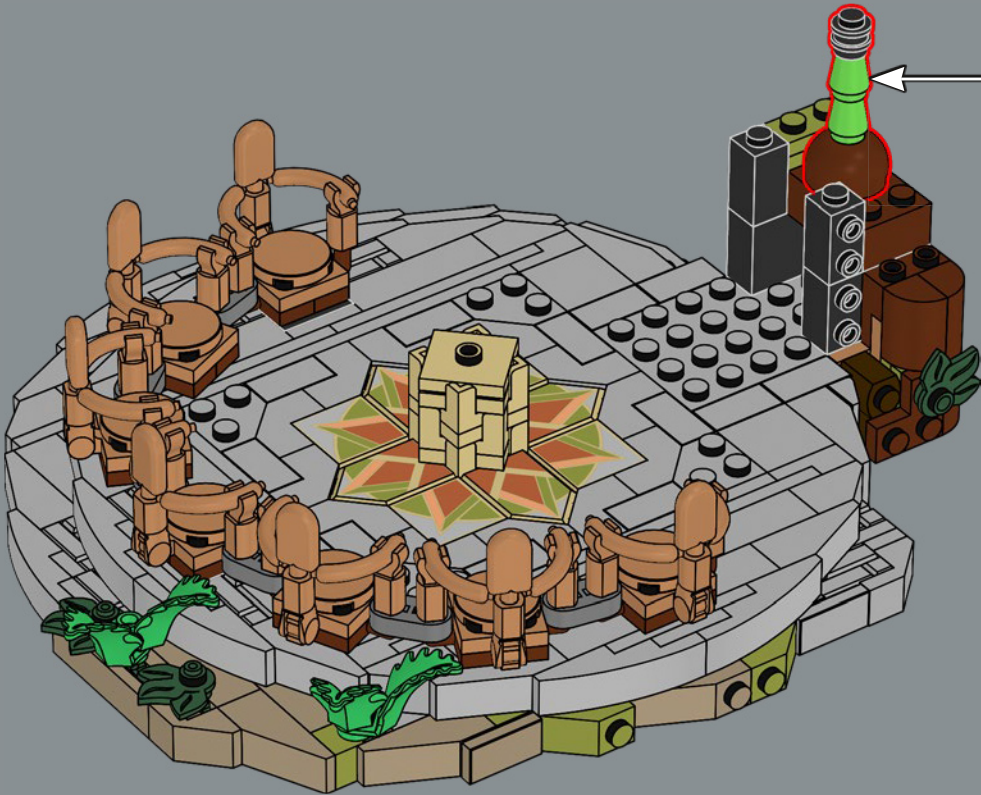

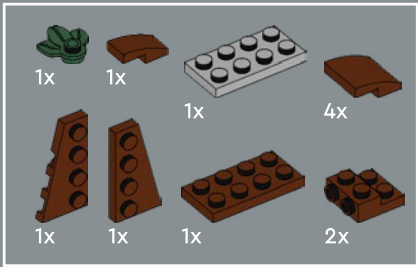

376

1



2

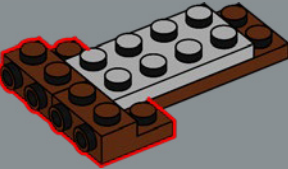

3

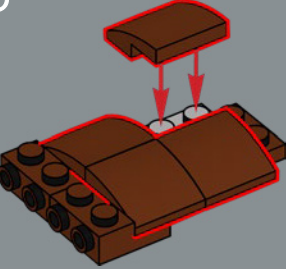

4

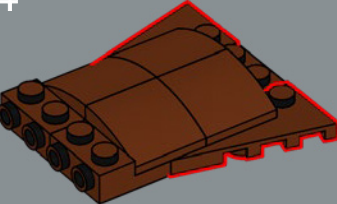

5

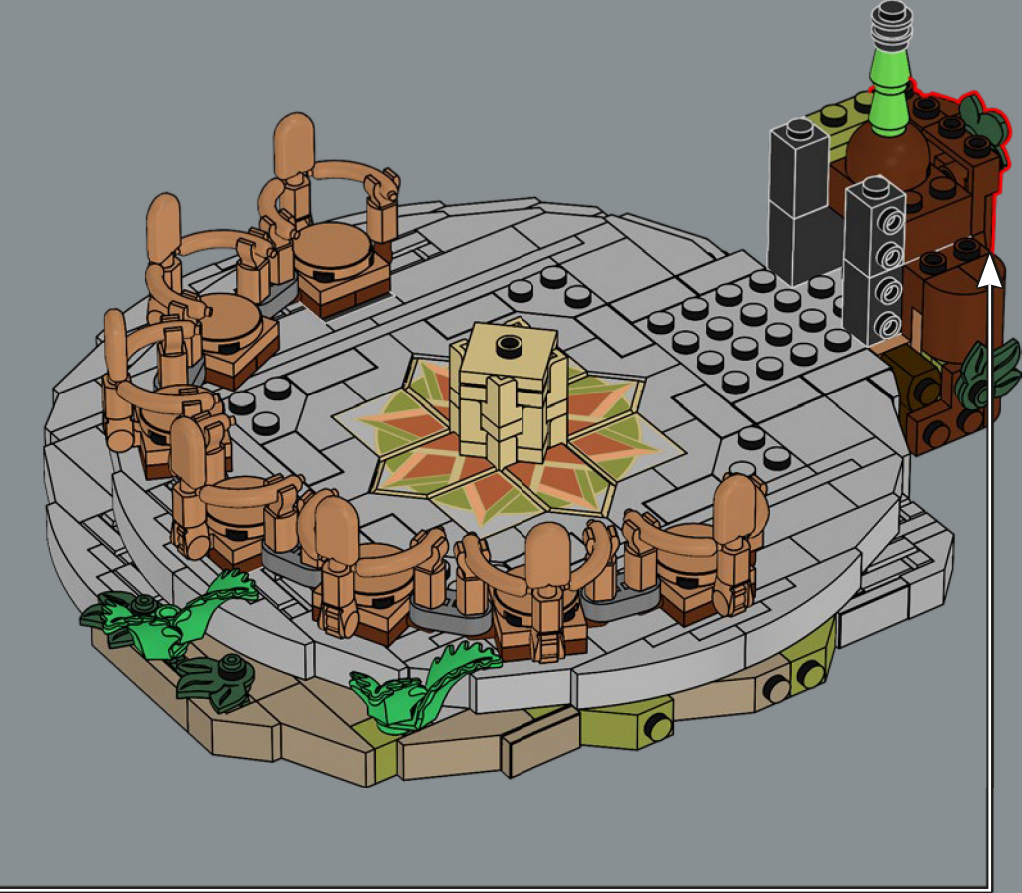
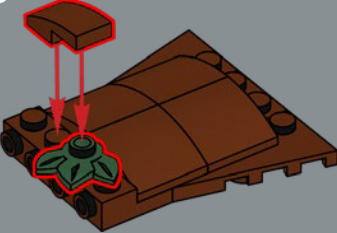

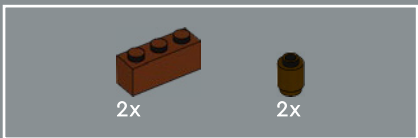

377

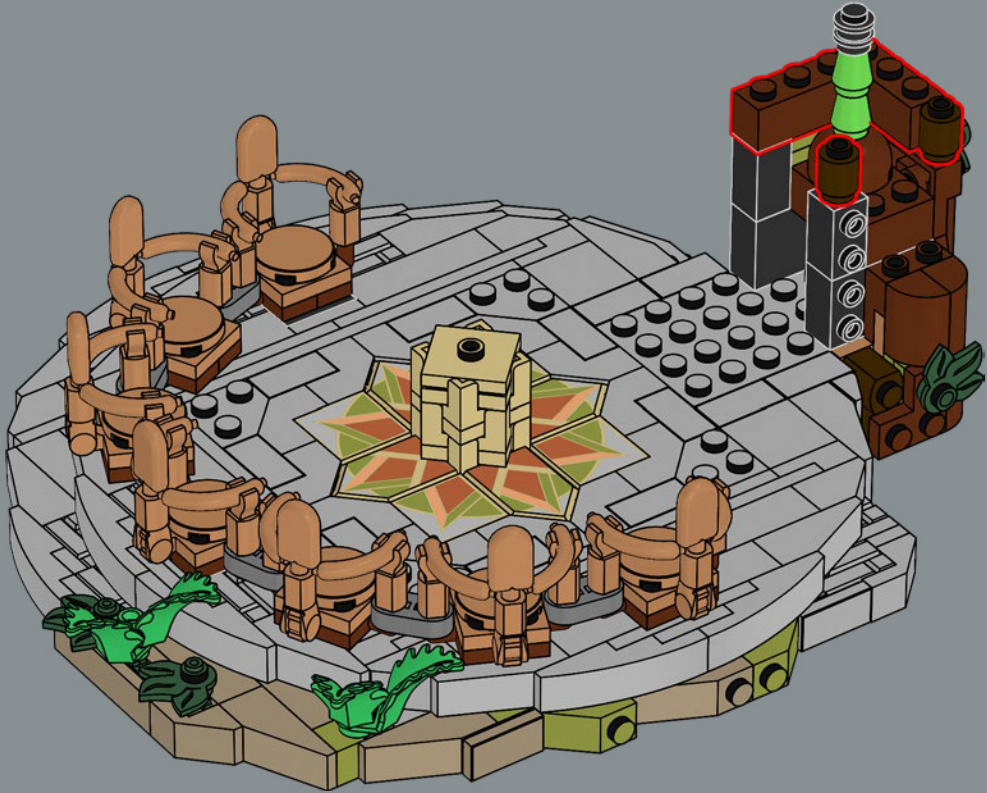

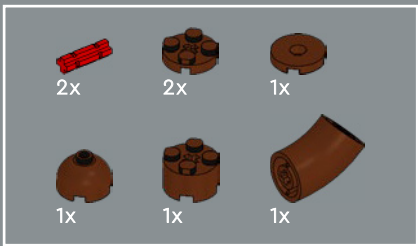

378

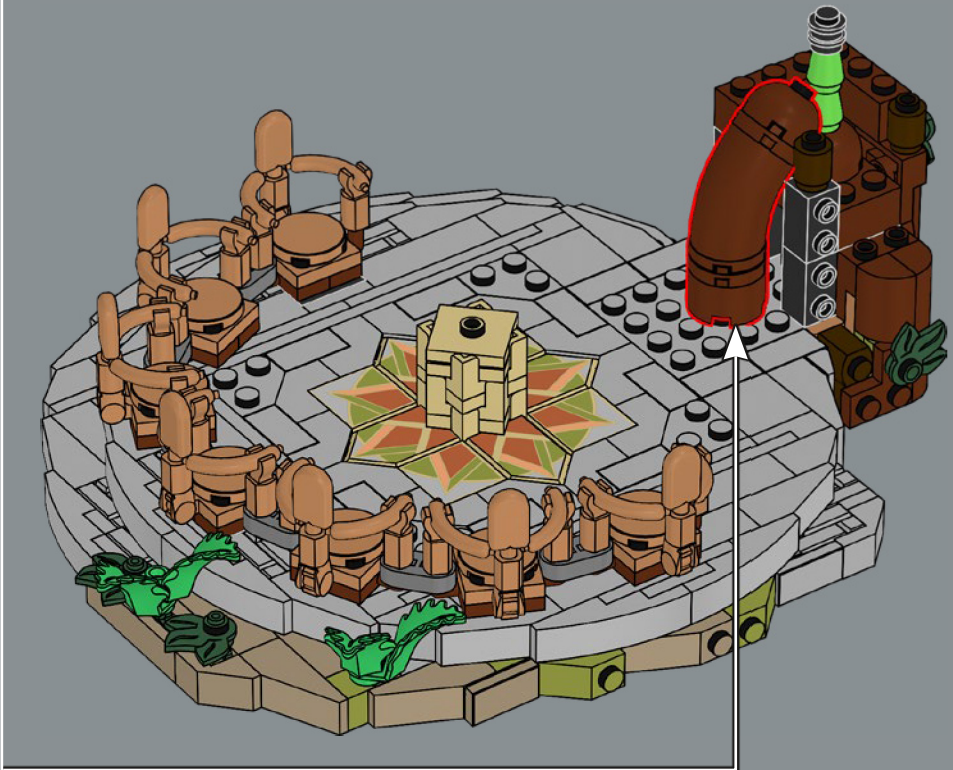
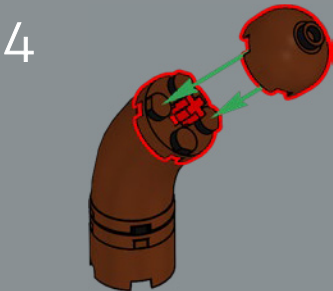
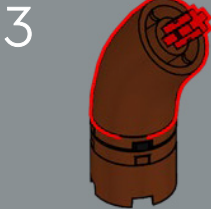
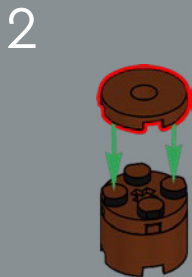
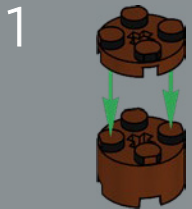
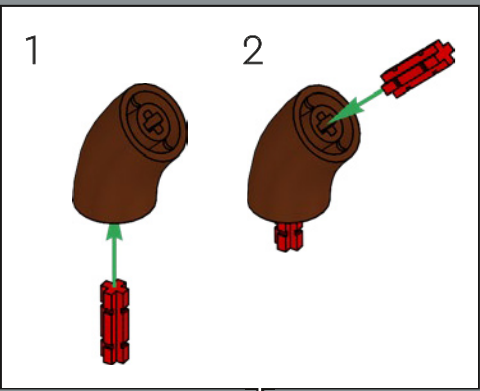

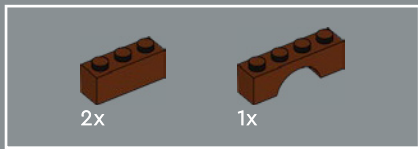

379

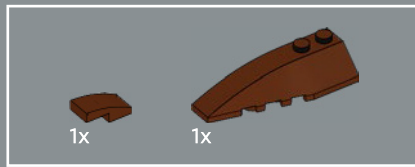
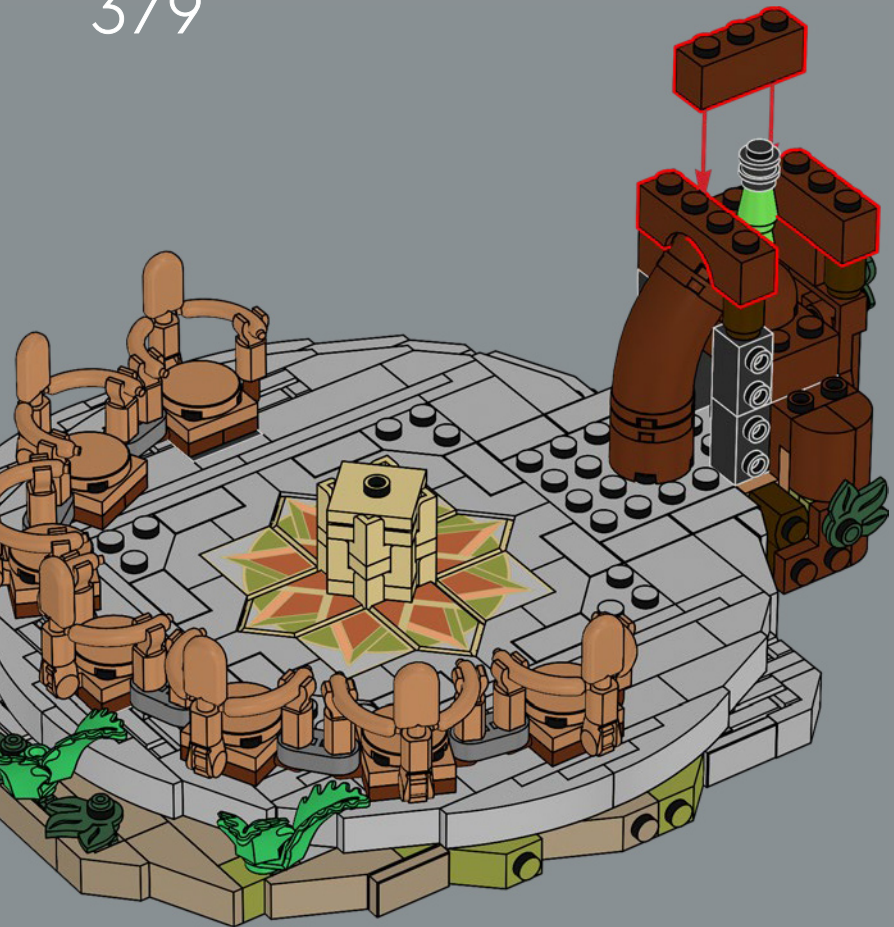

380

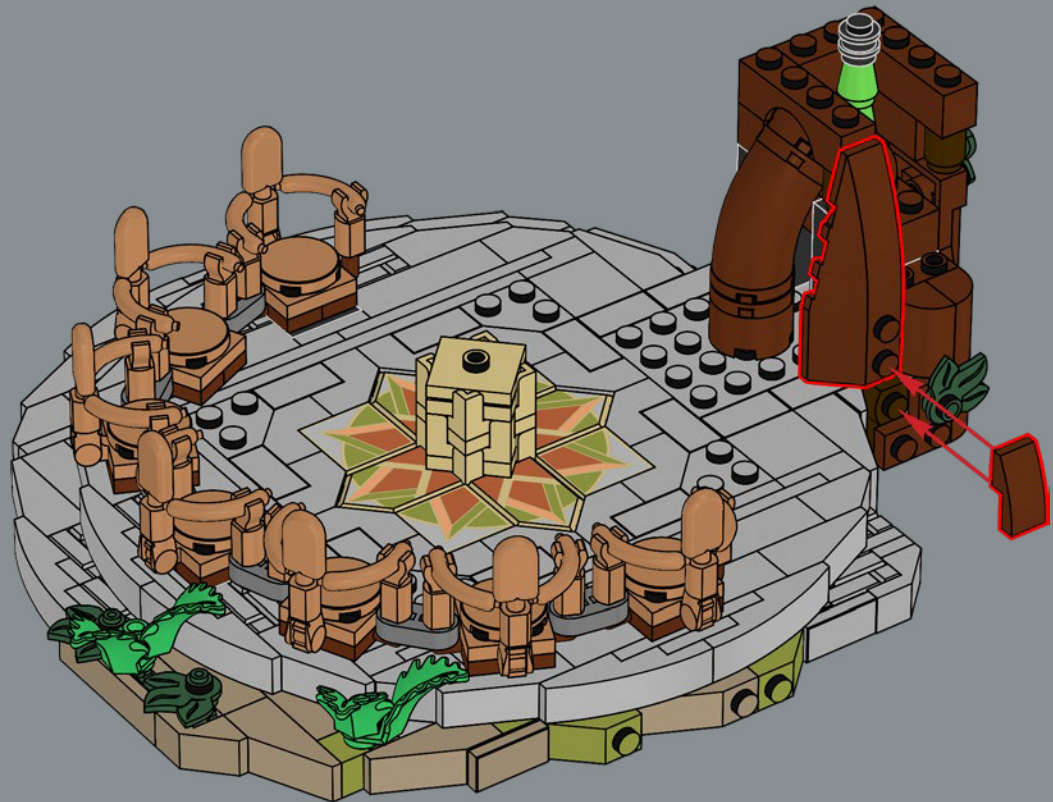

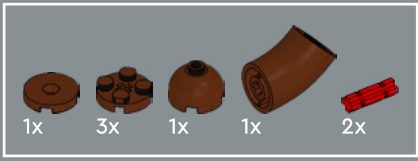

381

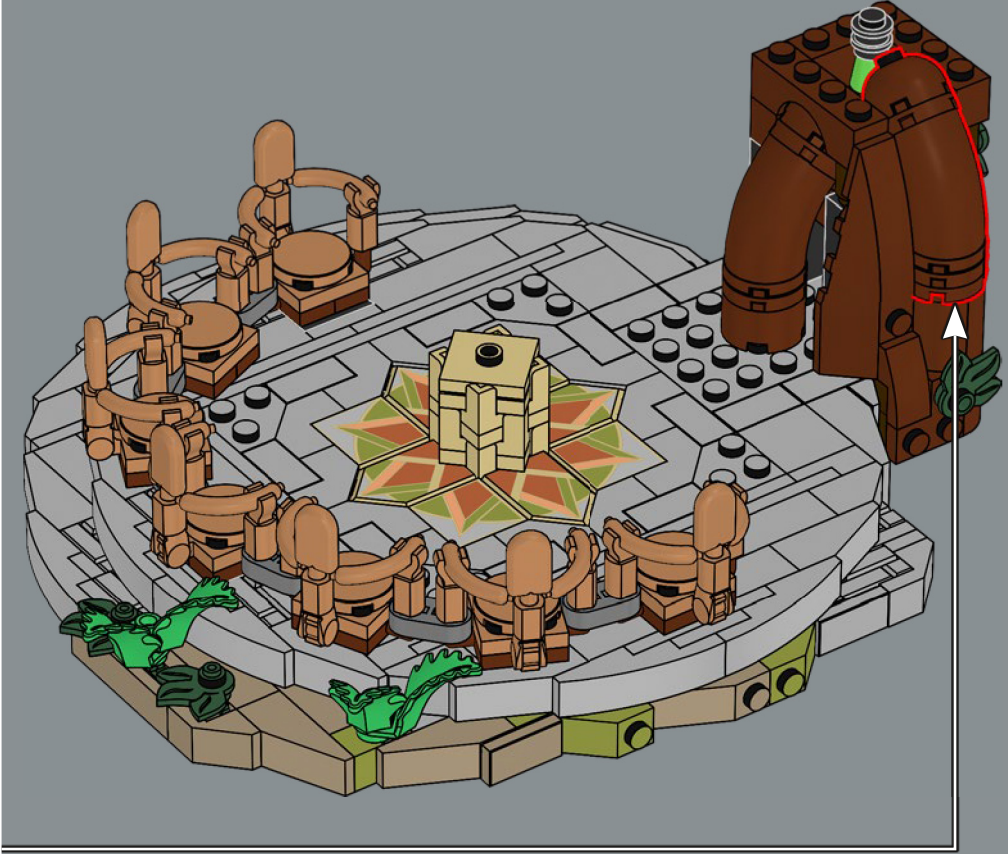
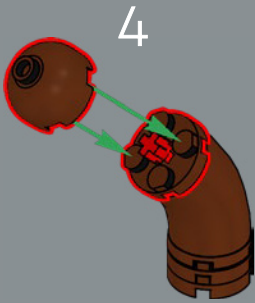
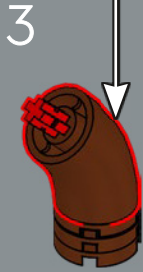
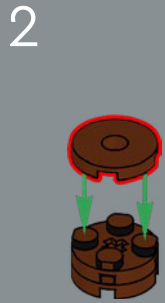
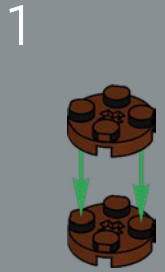
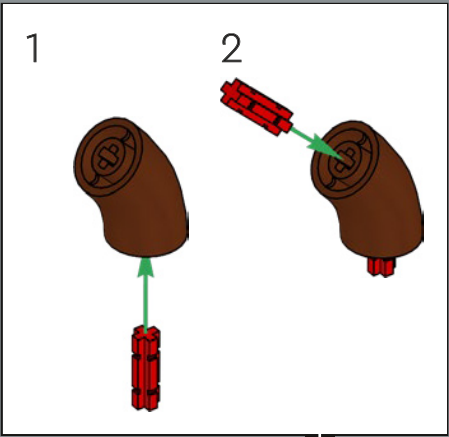

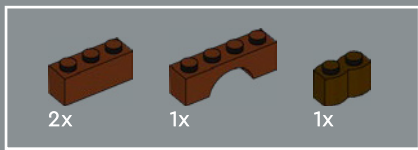

382

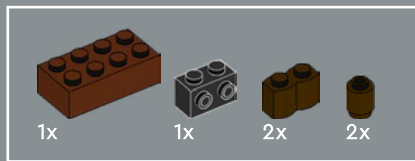
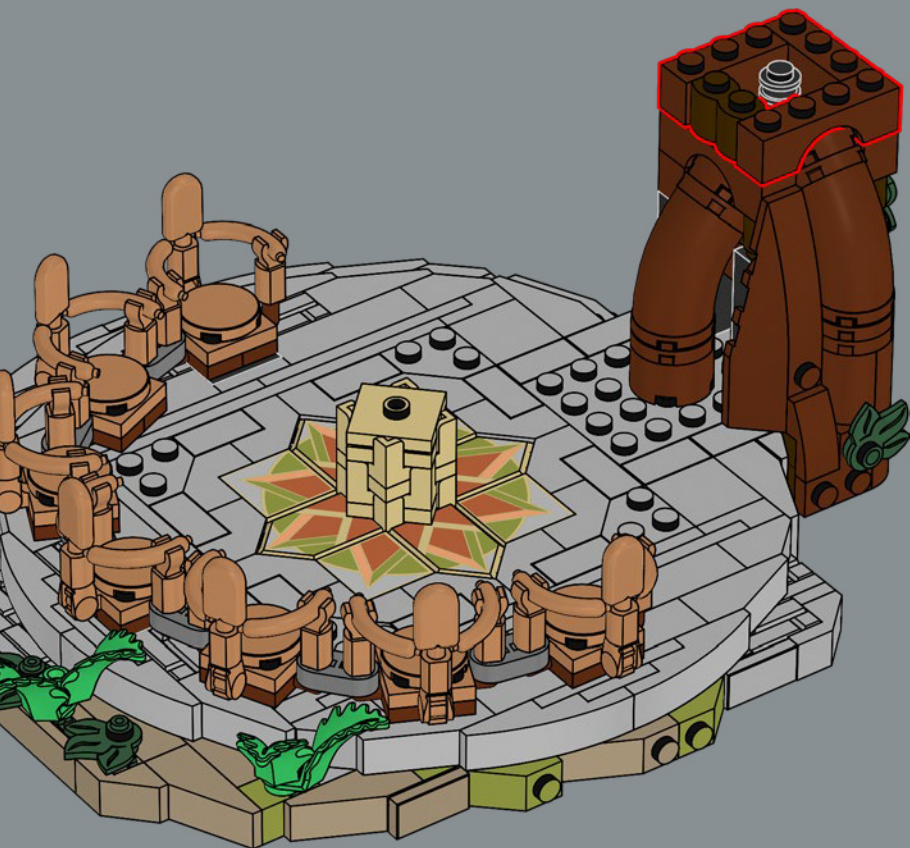

383

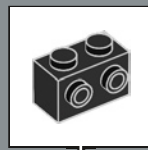
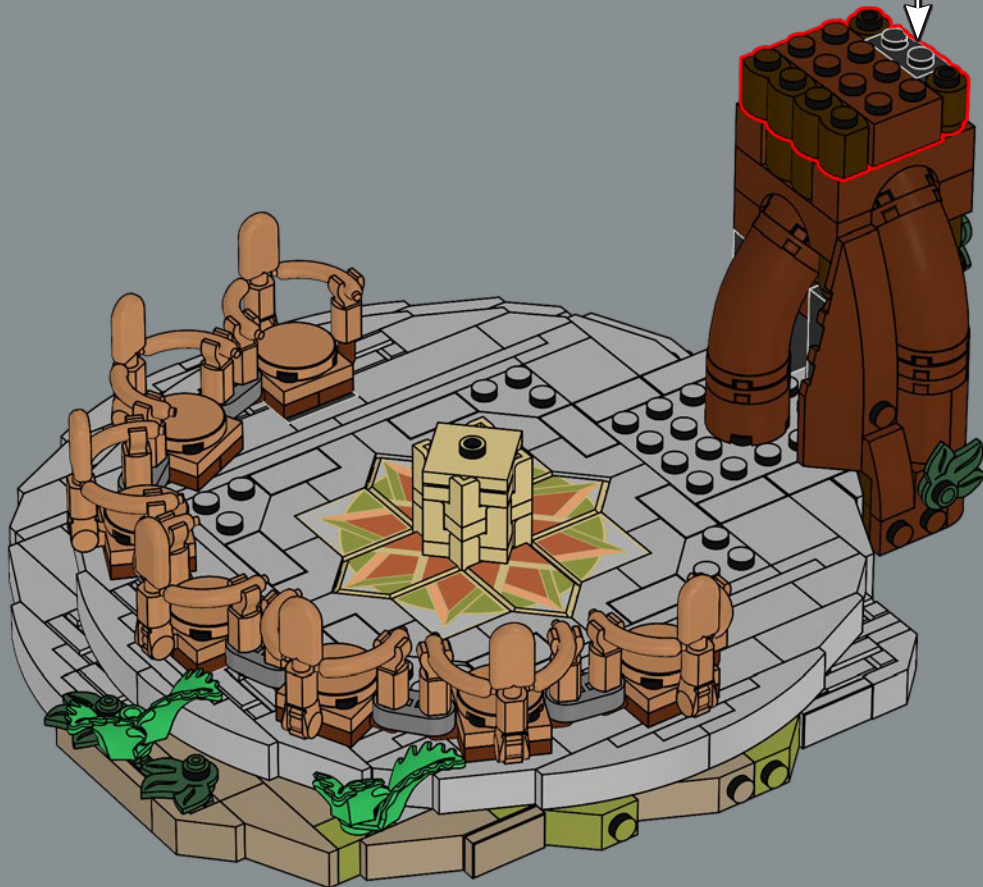

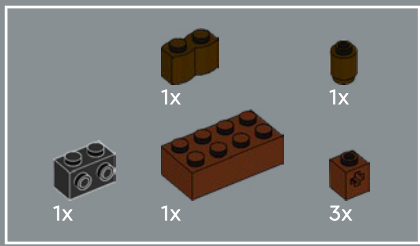

384

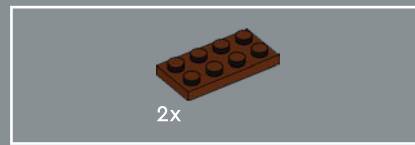
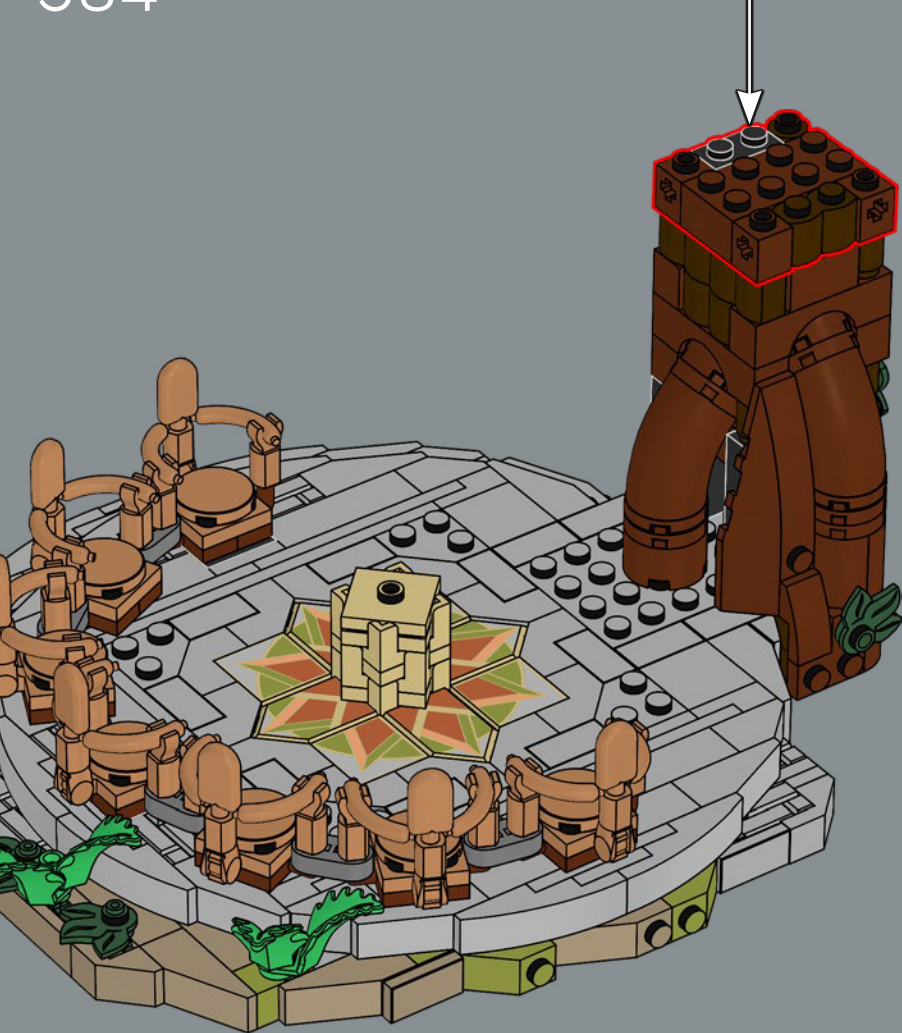
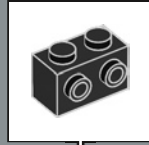

385

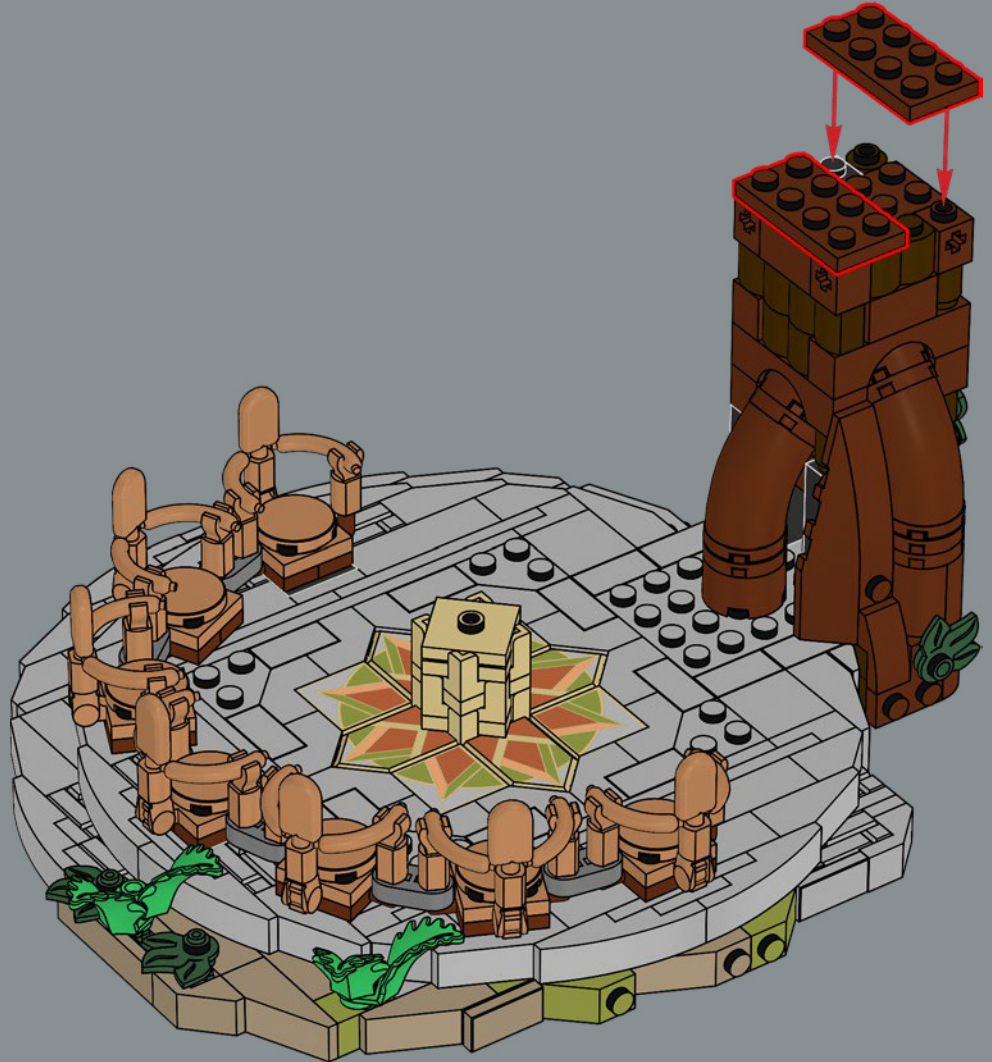



386

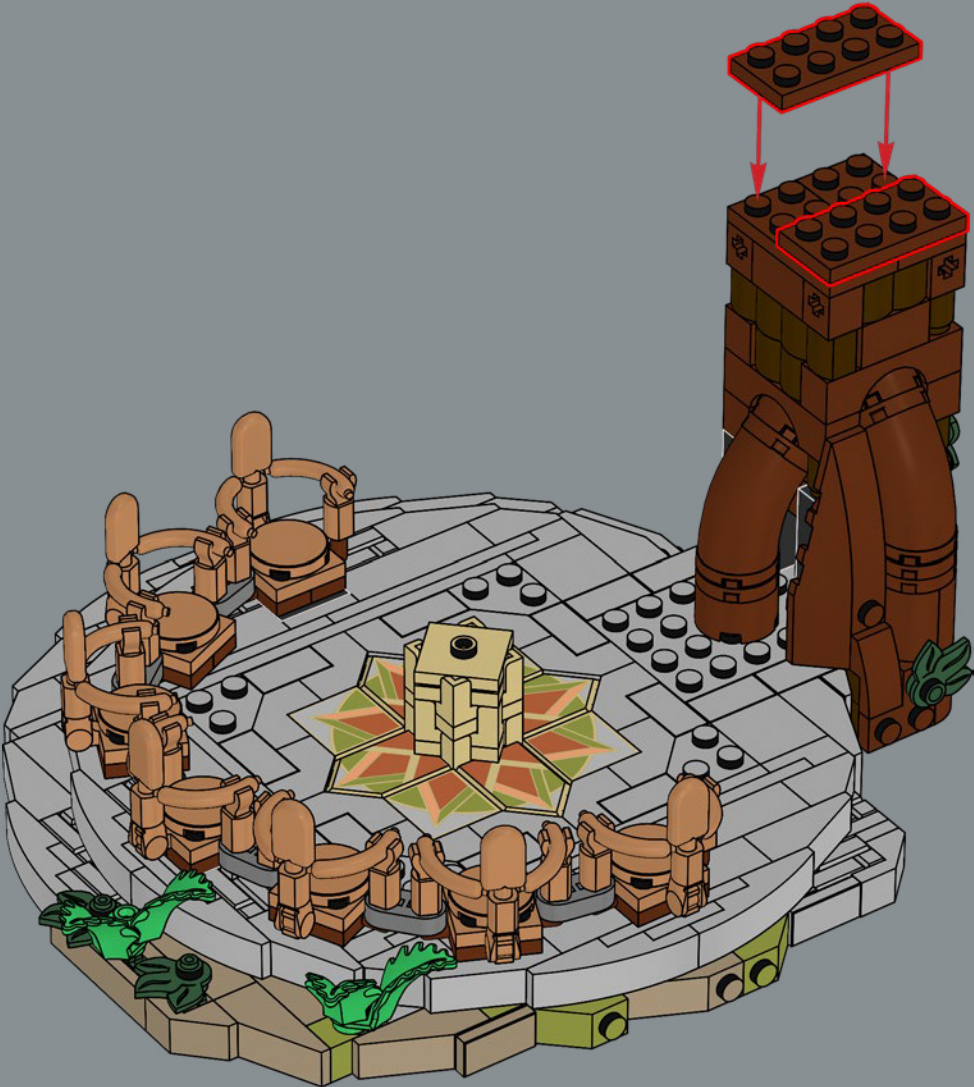

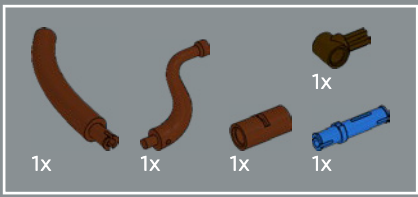

387

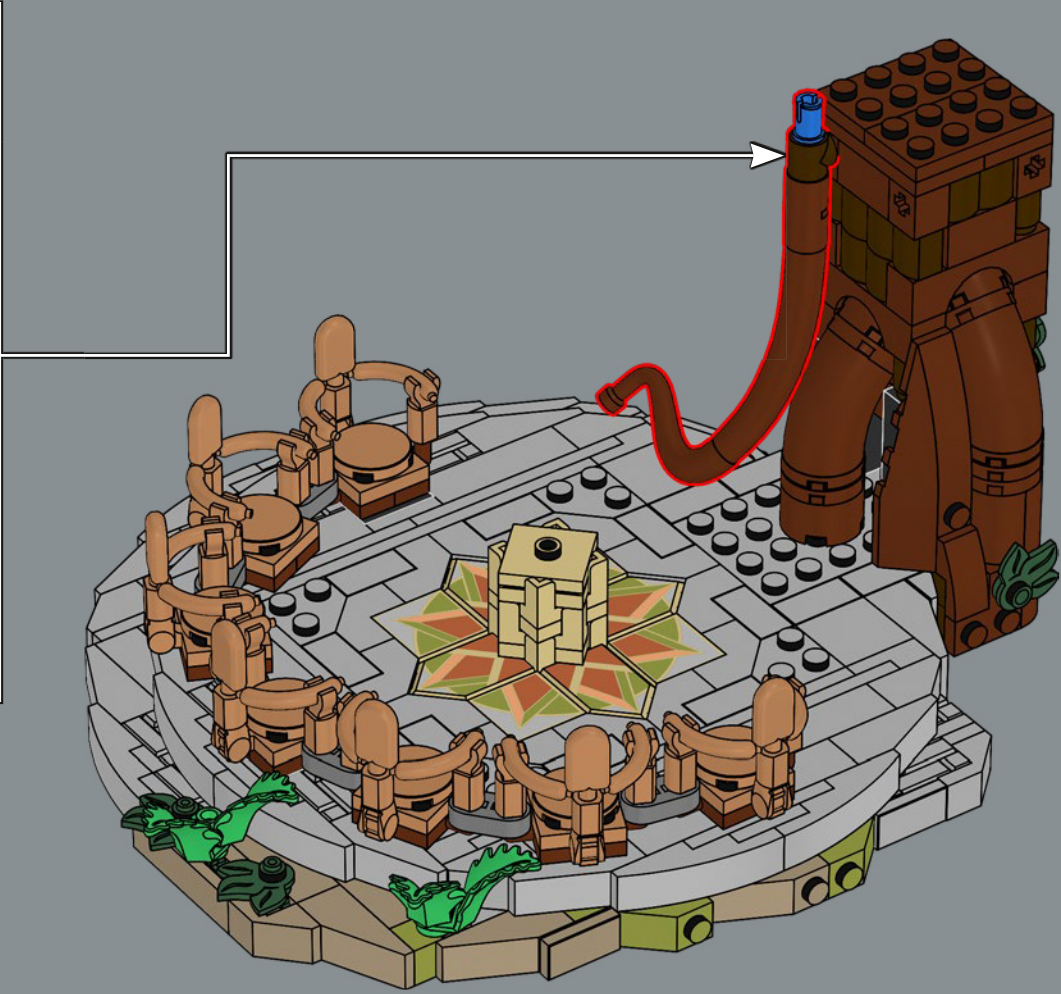
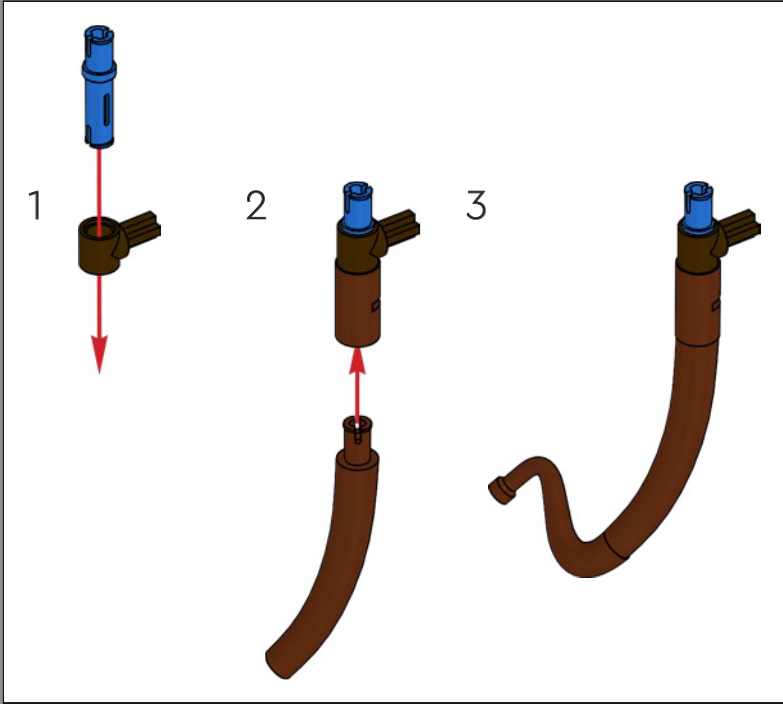

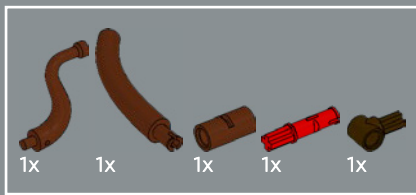

388

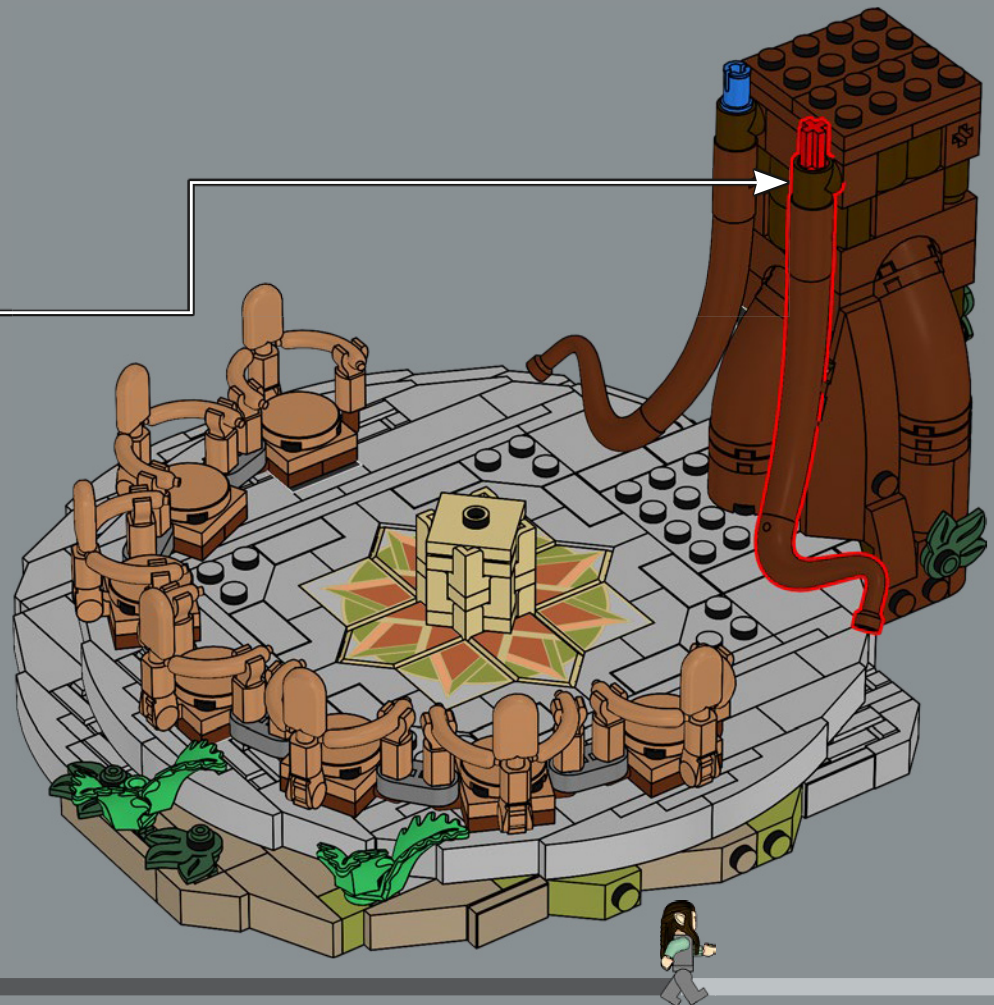
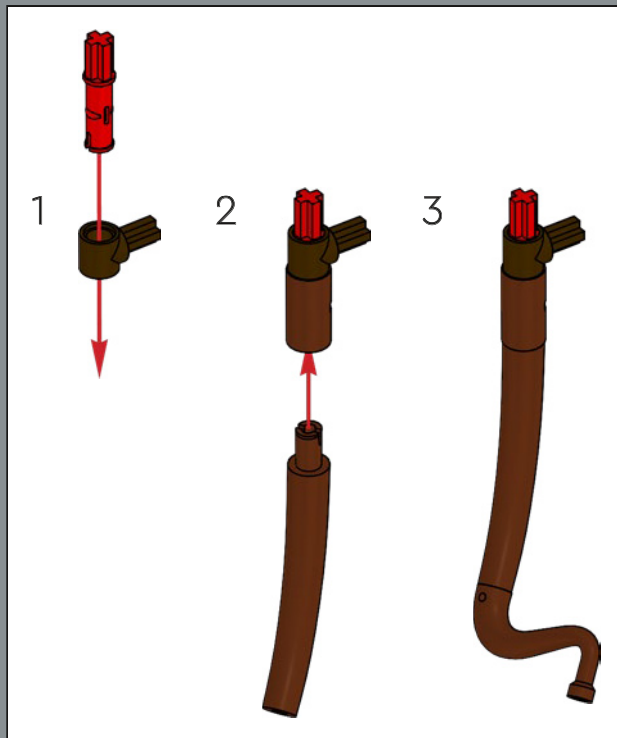

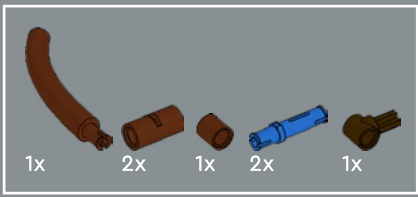

389

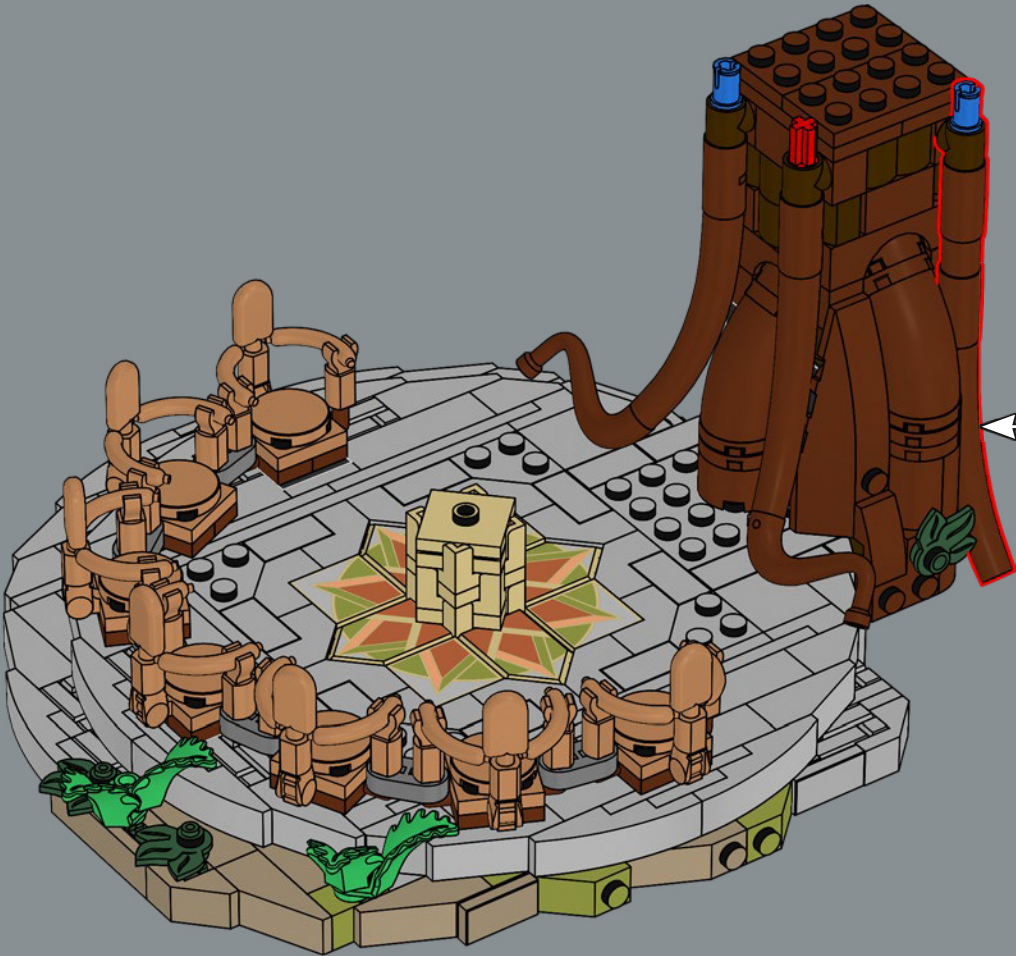
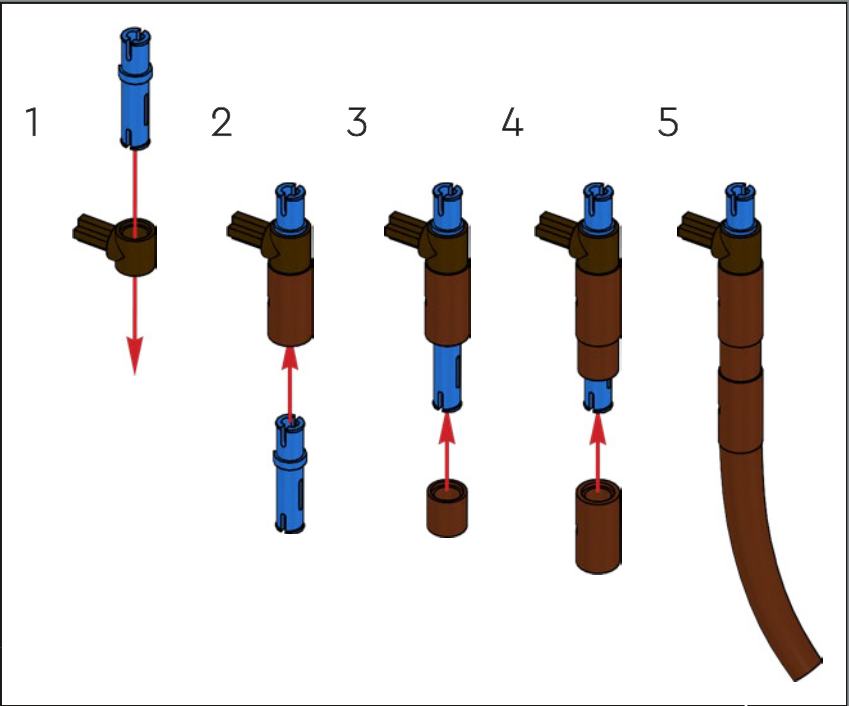

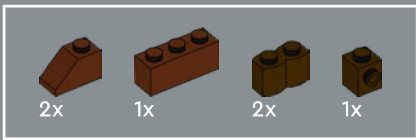

390



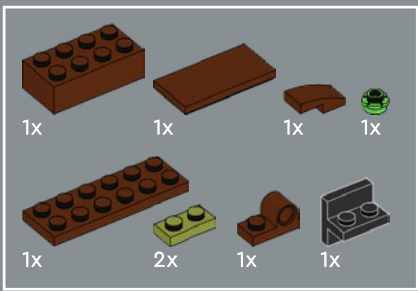

391

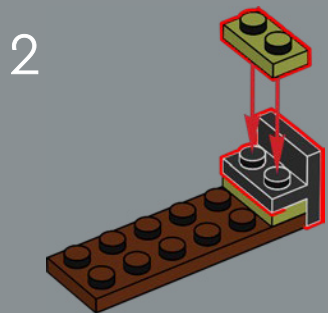
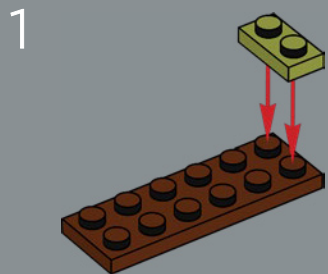

3

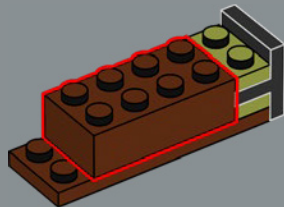

4

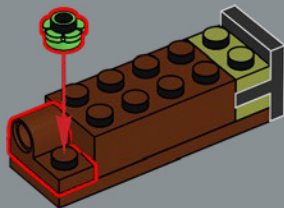

5

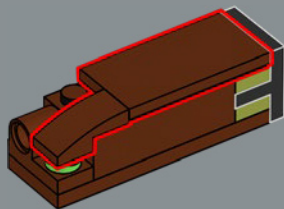

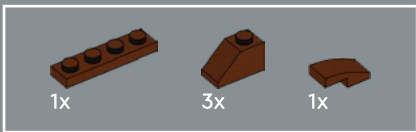

392

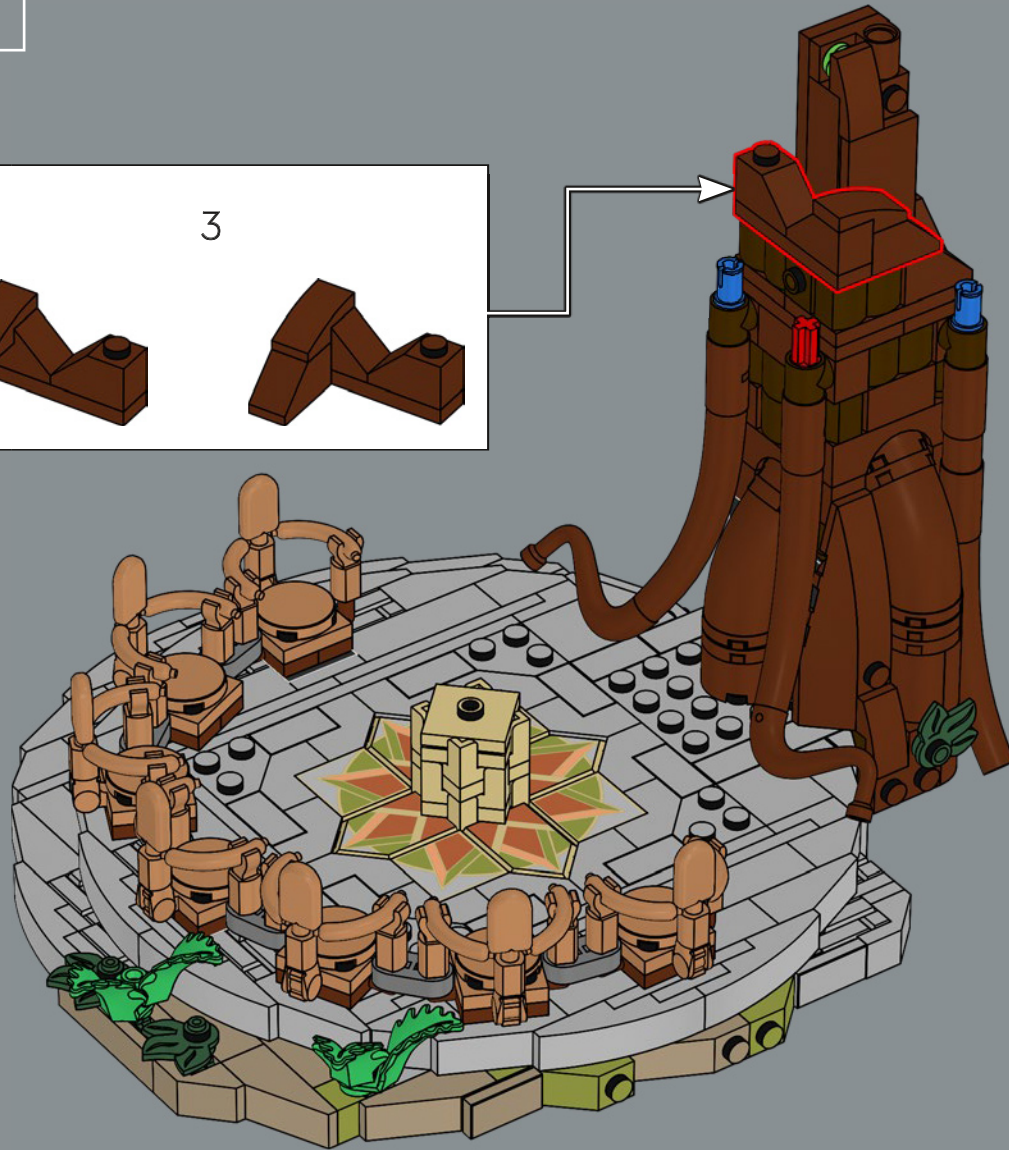
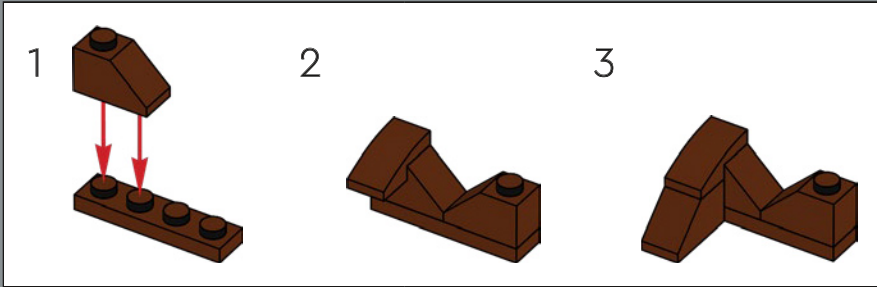

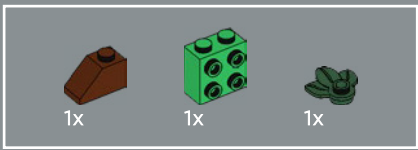

393

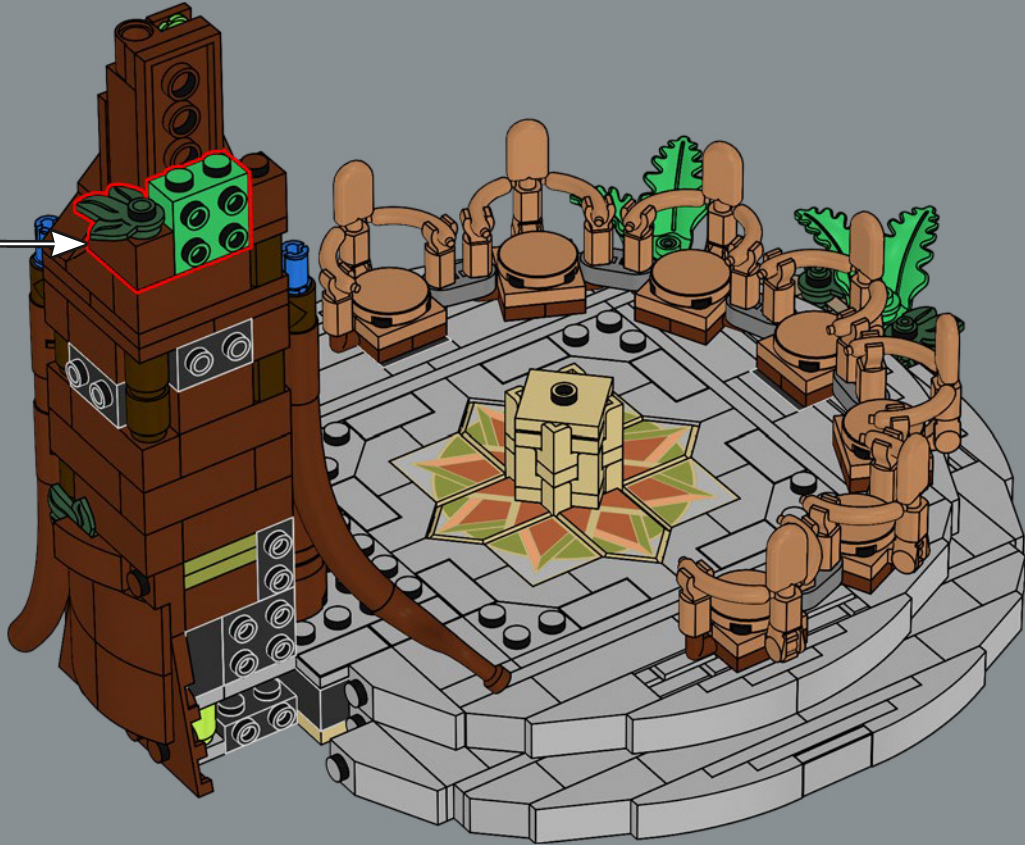
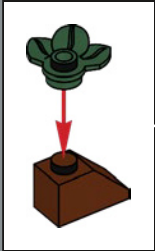

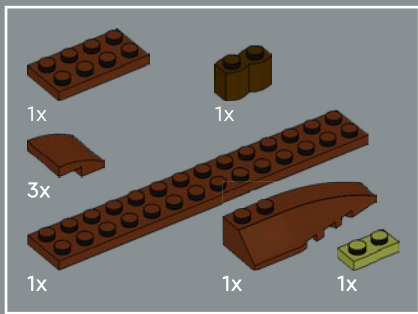

394

1

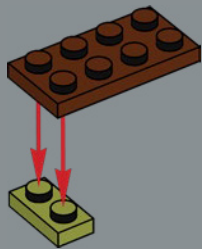

2

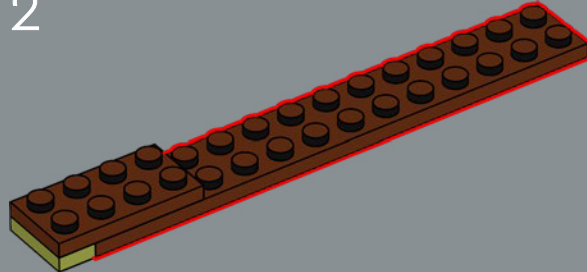

3

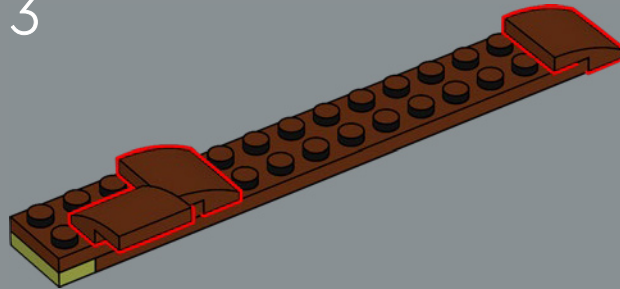

4

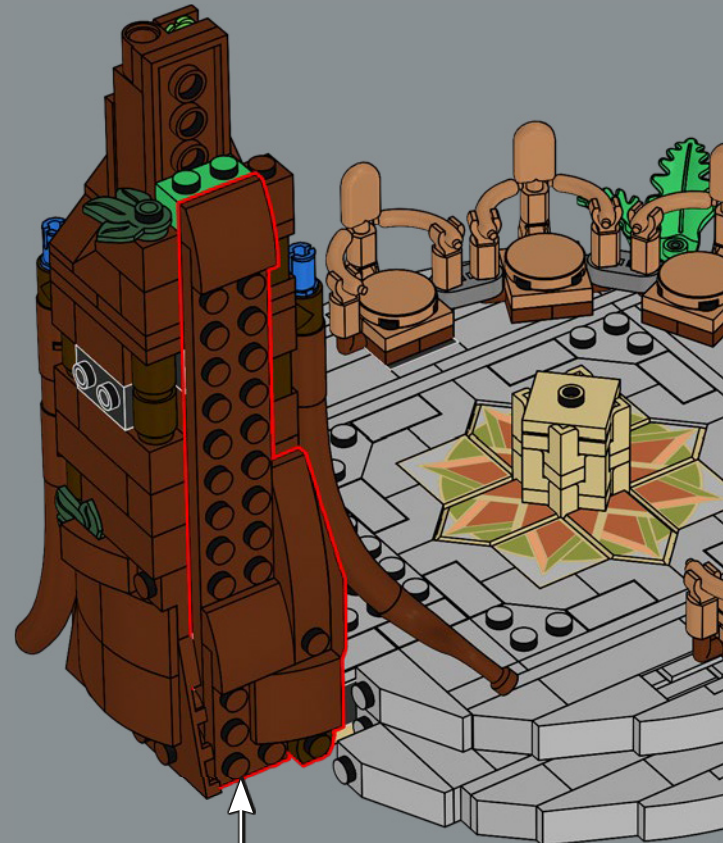
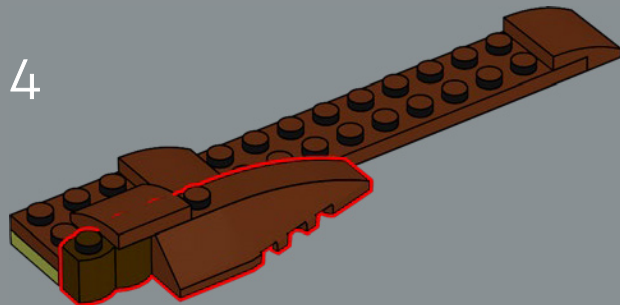

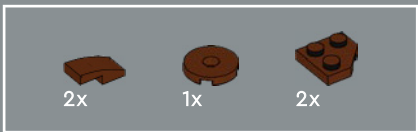

395

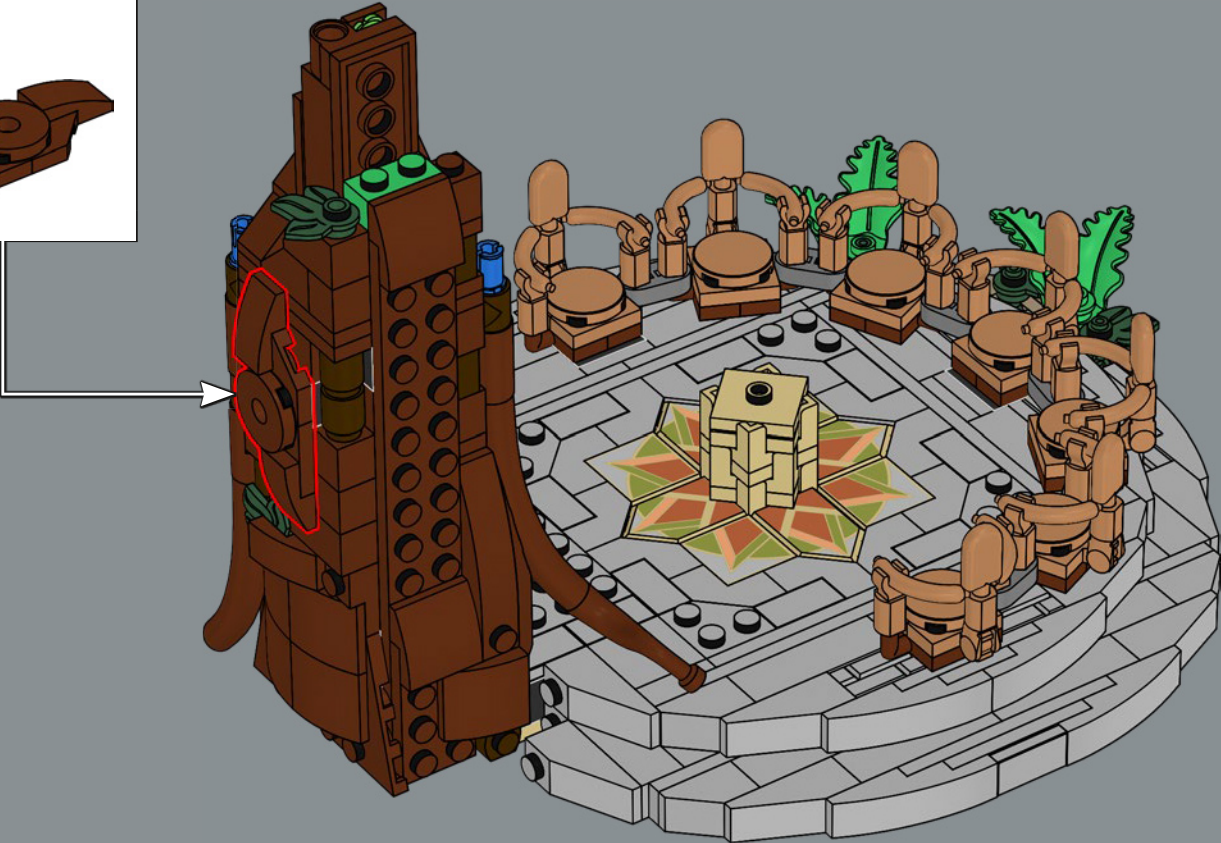
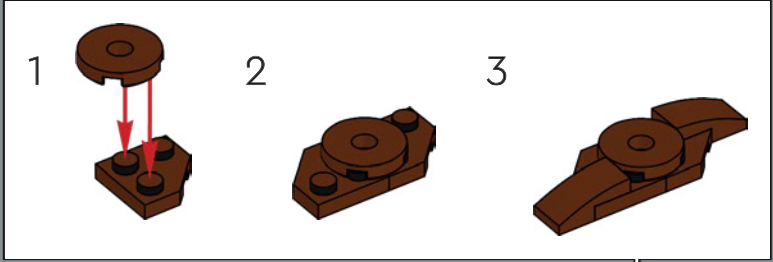

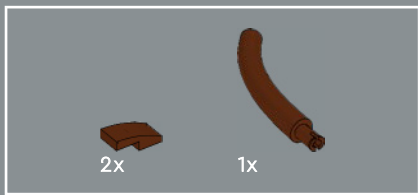

396

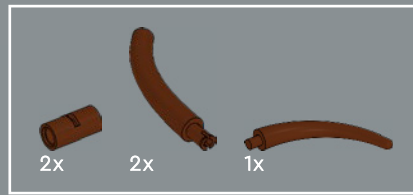
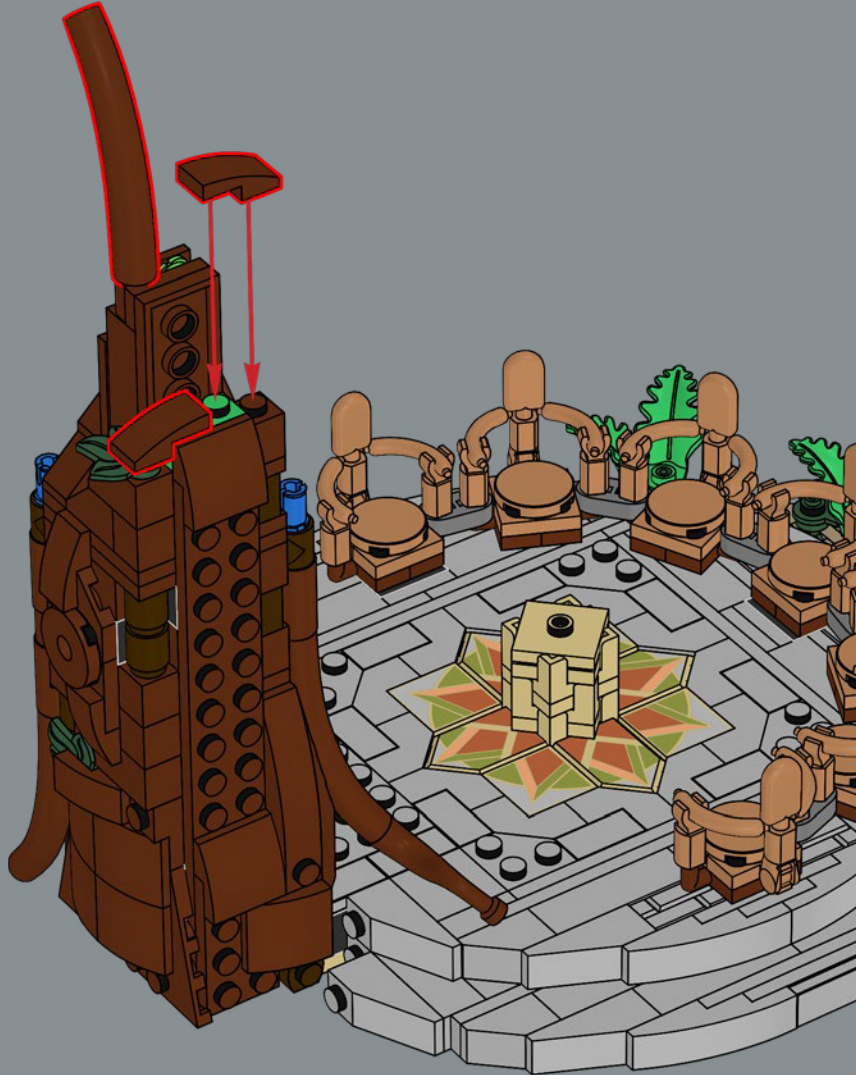

397

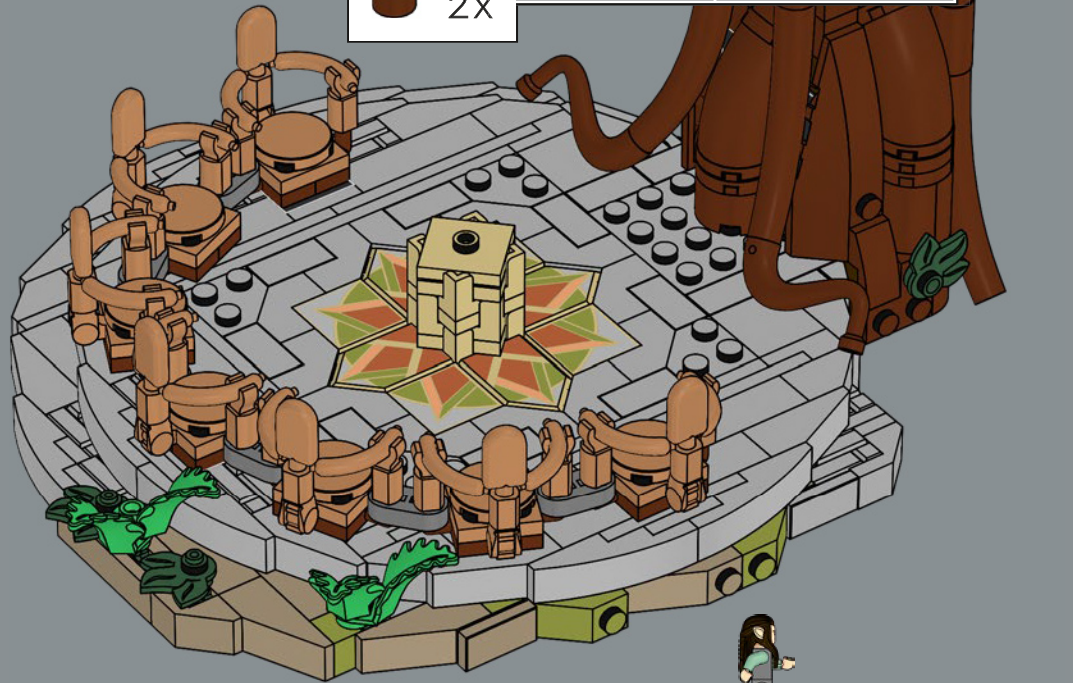
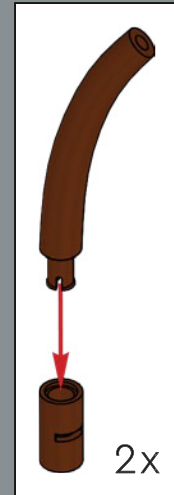

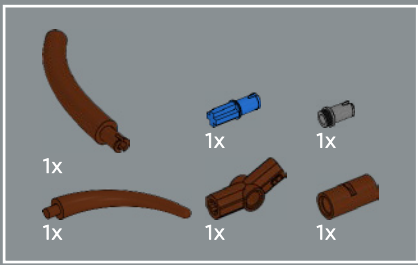

398

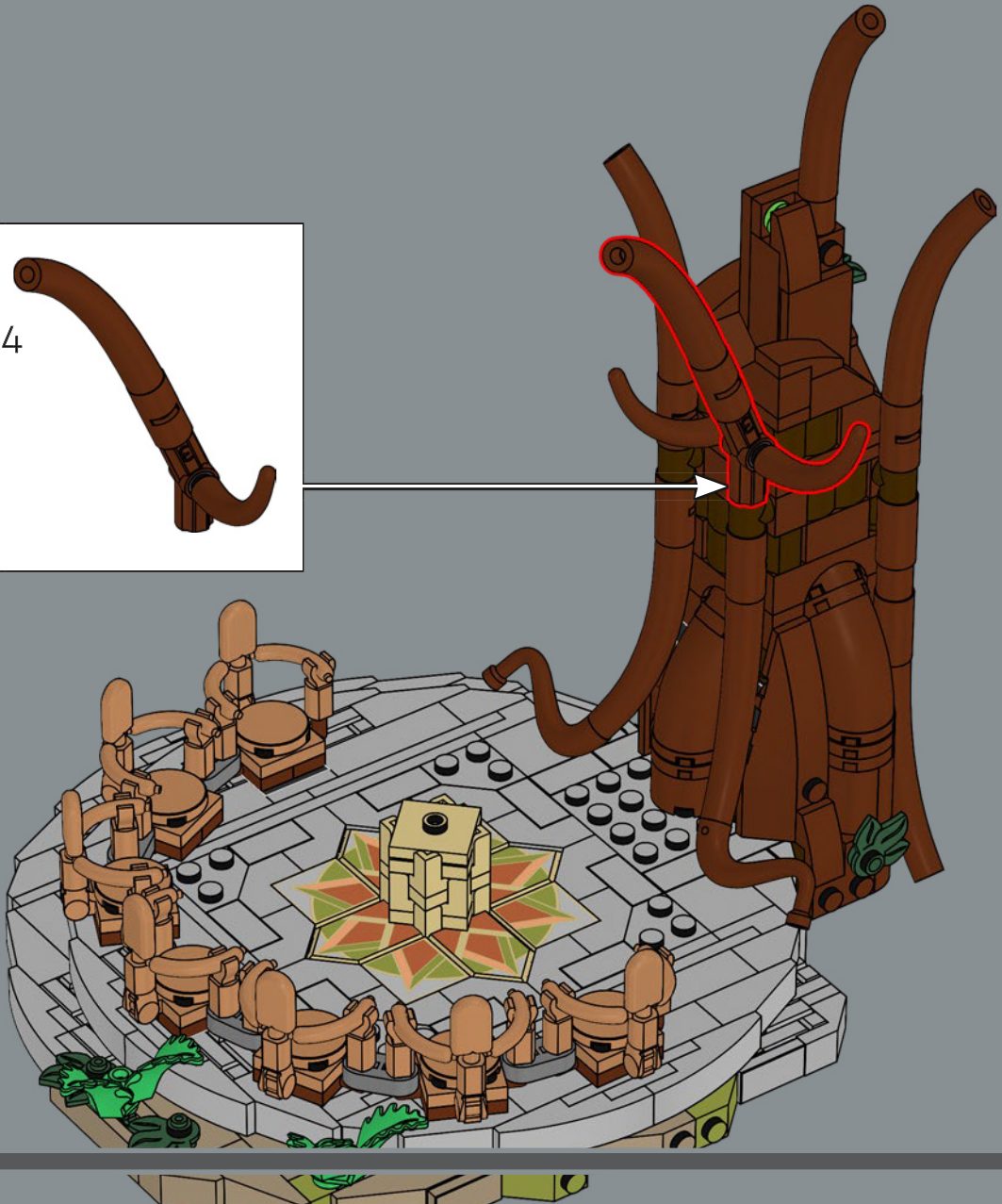
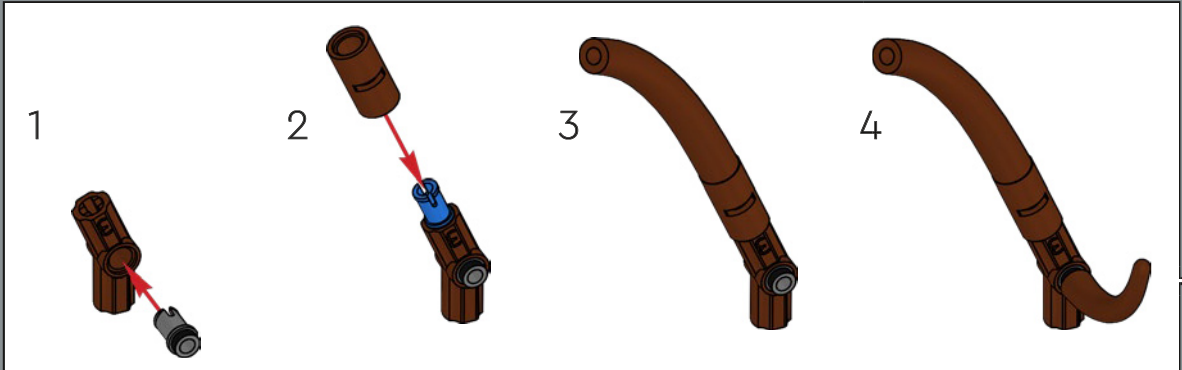

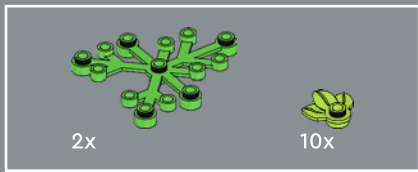

399

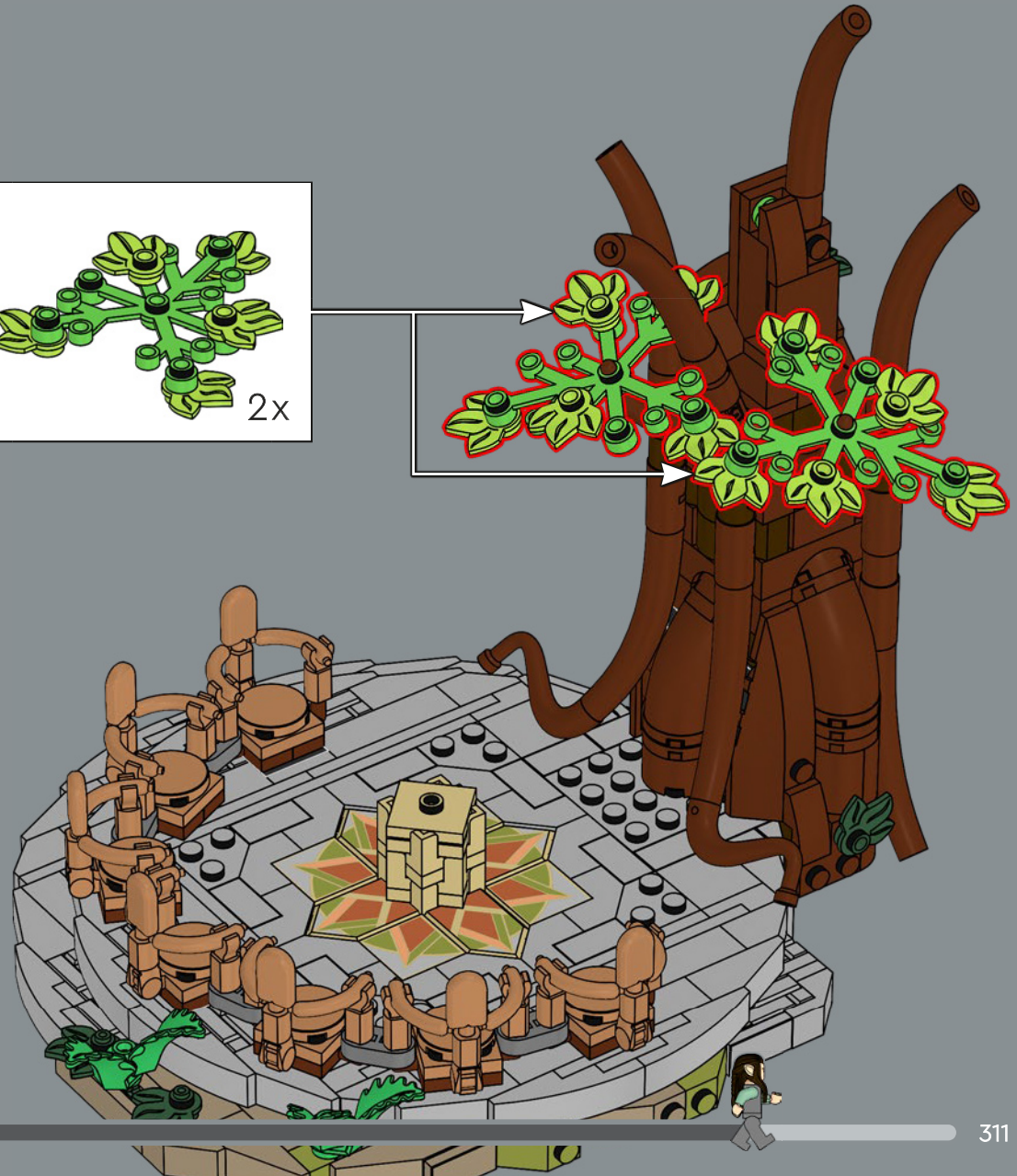
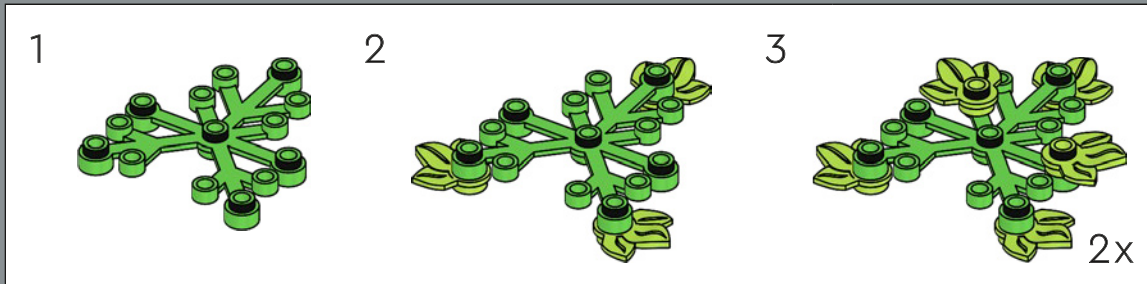



Noch mehr blaugrüne Teile? Elrond hat wirklich den besten Stuhl von uns bekommen.



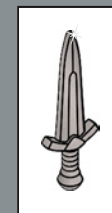
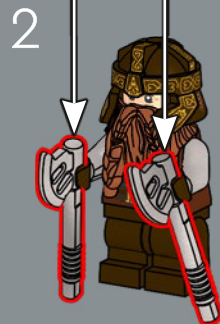
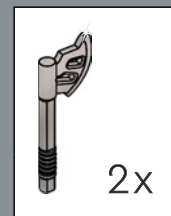
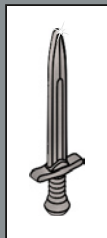
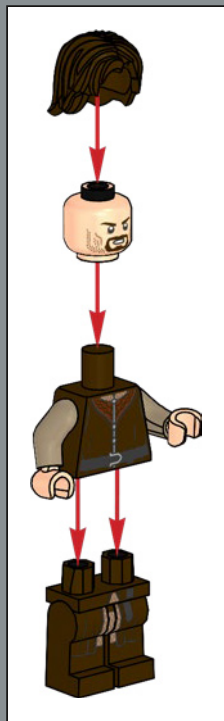
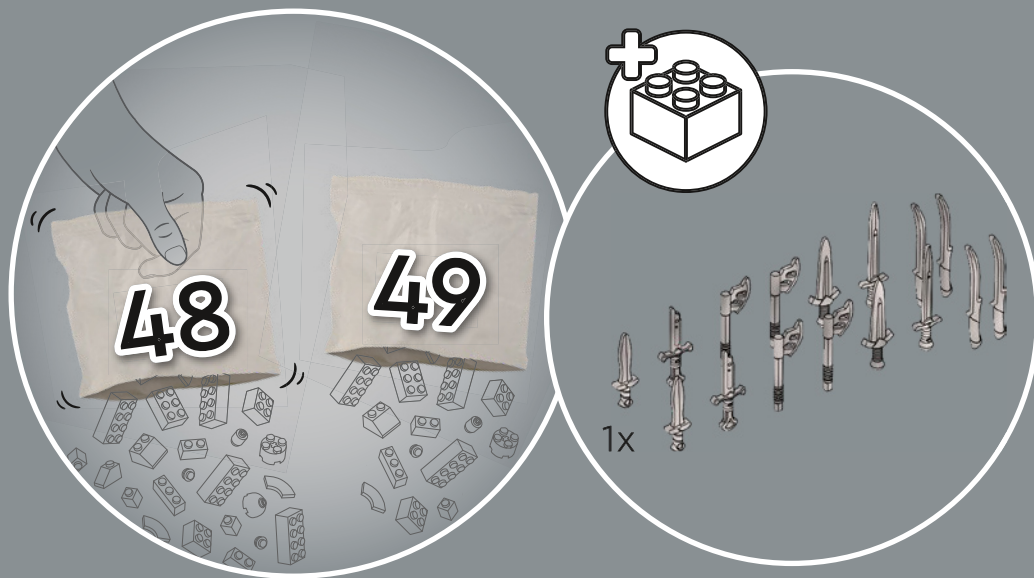

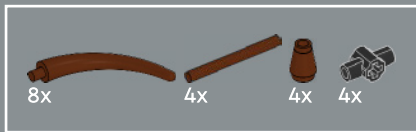

401

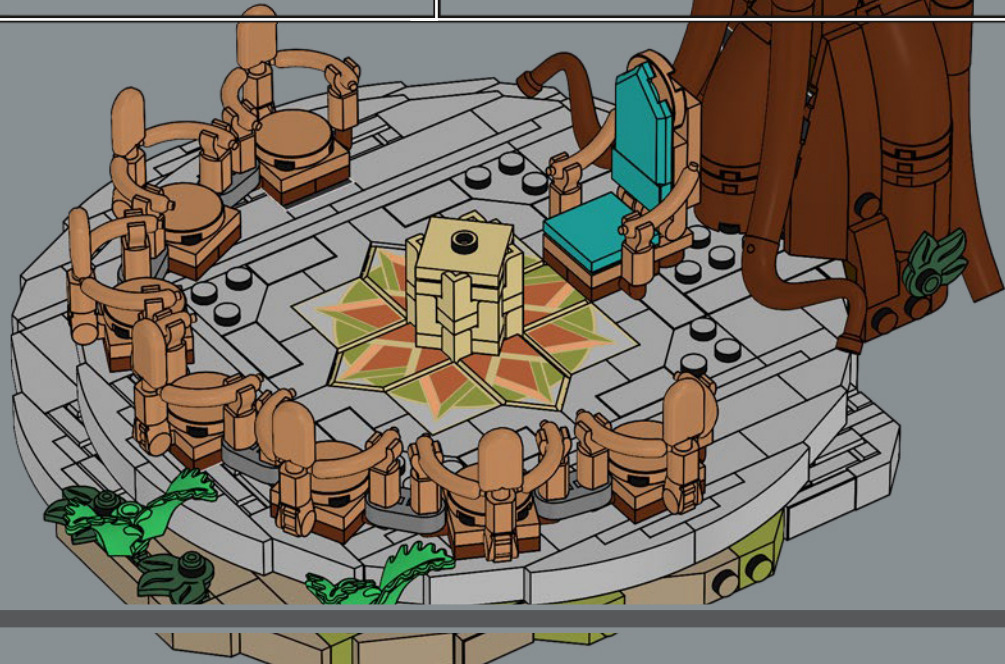
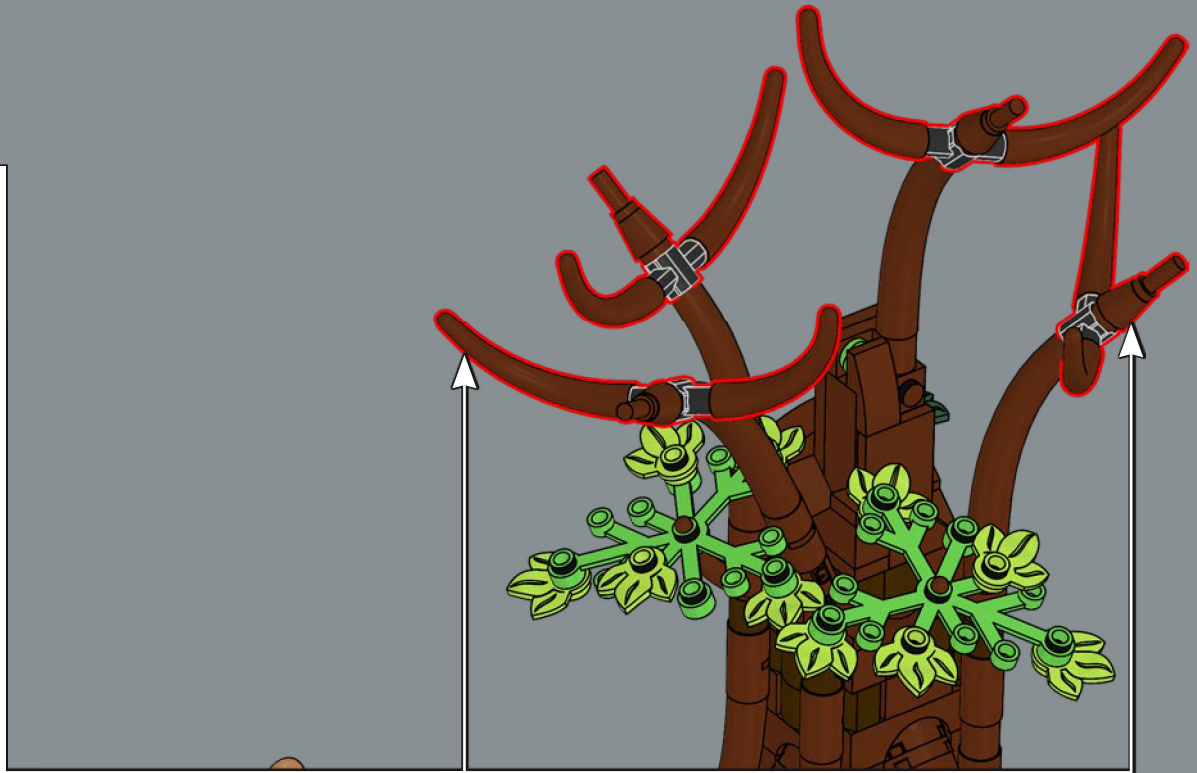
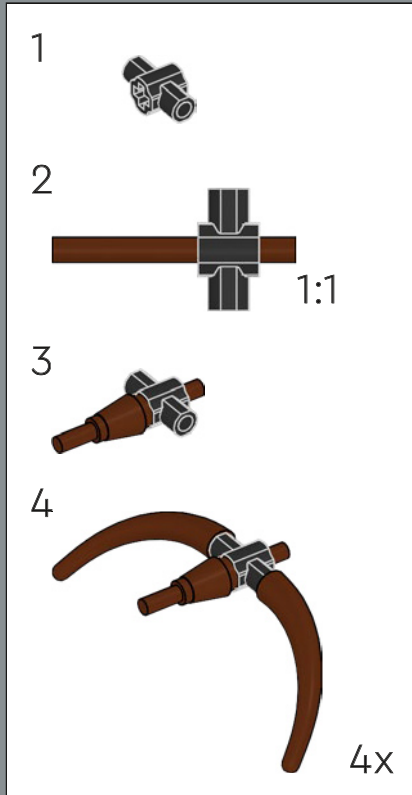

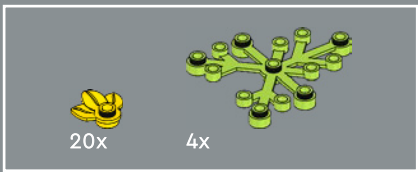

402

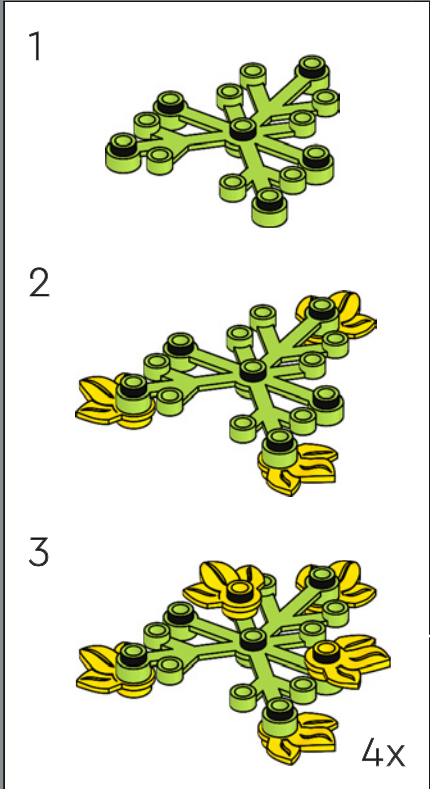

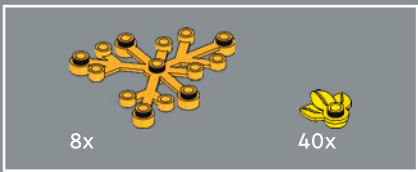

403

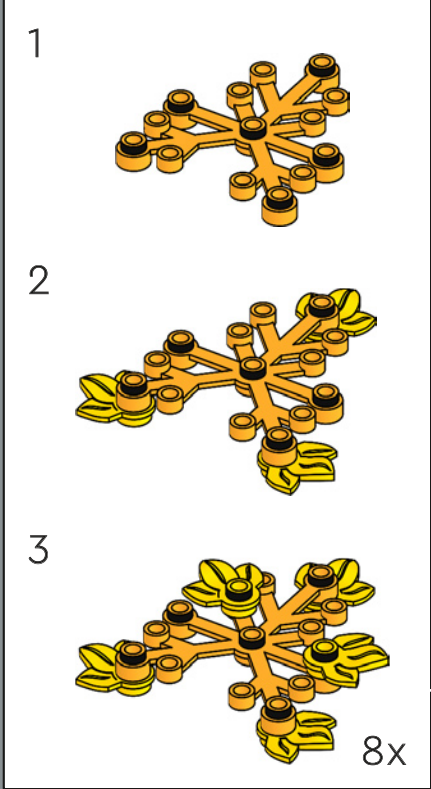



405



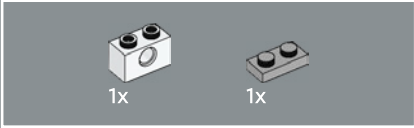
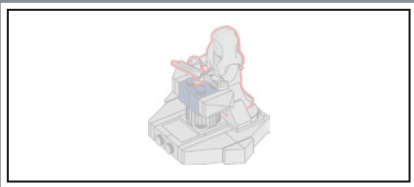

406

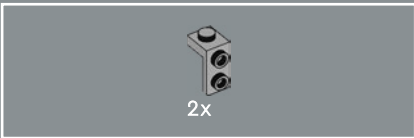
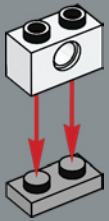

407

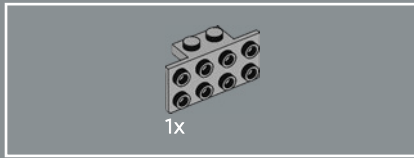
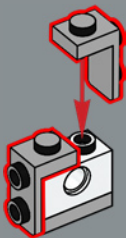

408

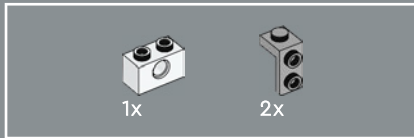
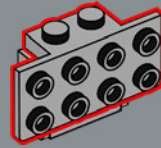

409

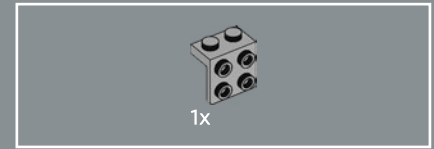
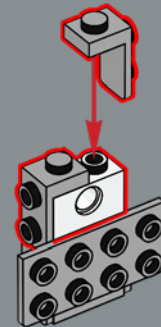

410

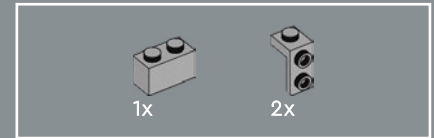
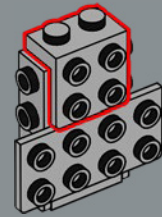

411

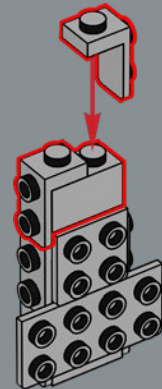

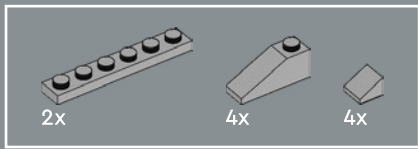

412

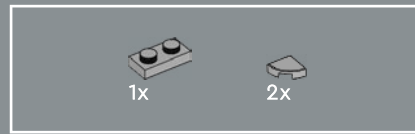
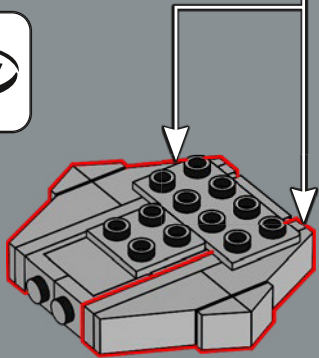
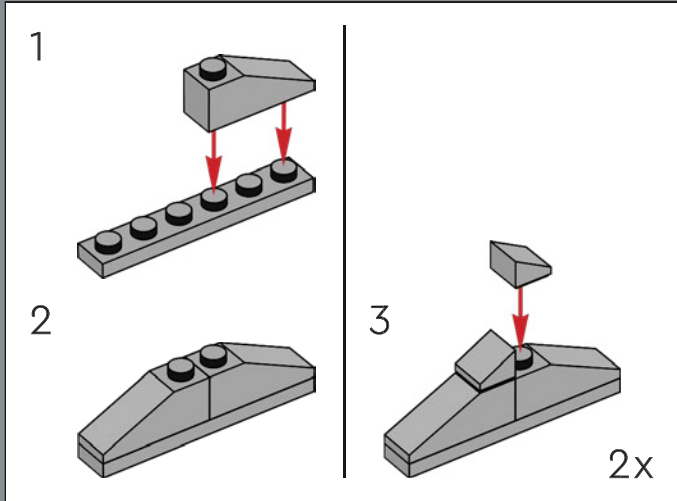

413

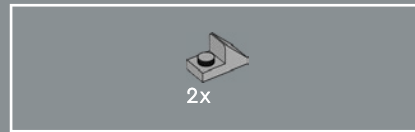
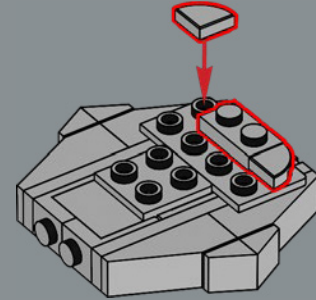

414

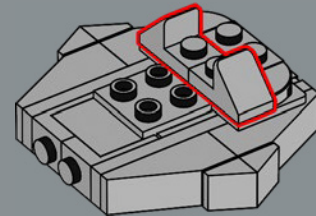



1x

415

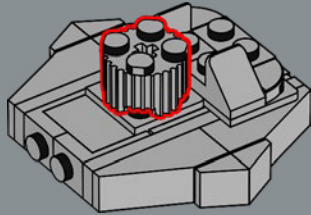

2x



2x



2x

416

1

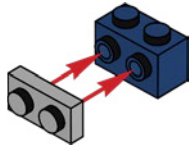

2

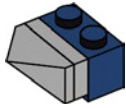

2x

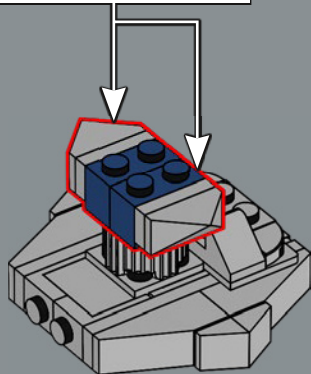

417

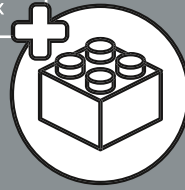

1

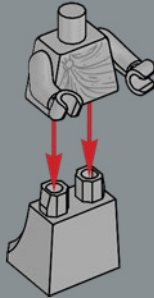

2

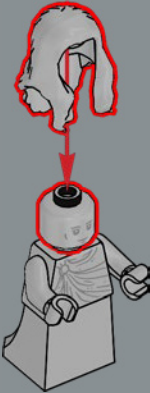

3

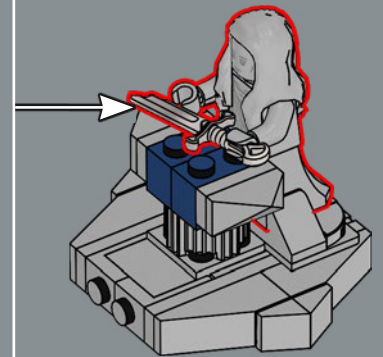
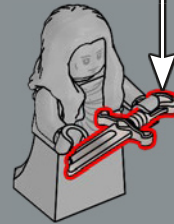

418



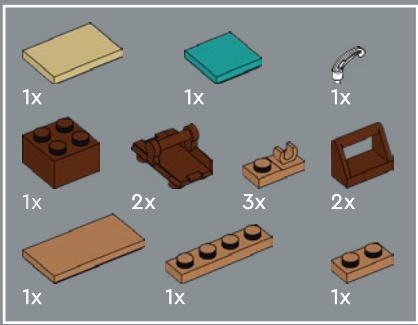

419

3

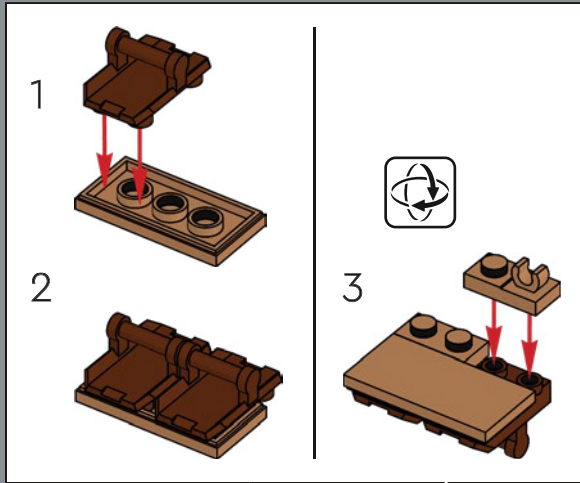
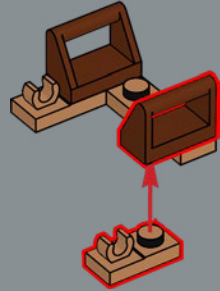

4

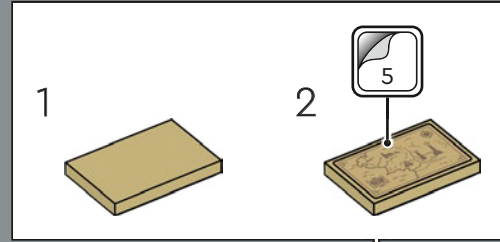
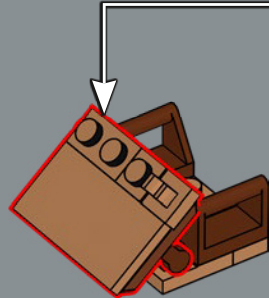

6

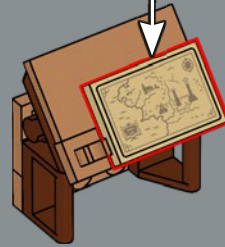

5

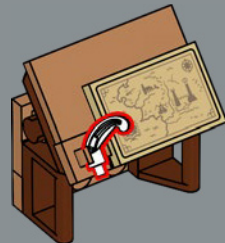

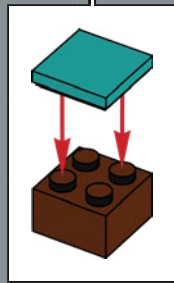

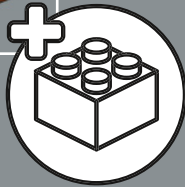
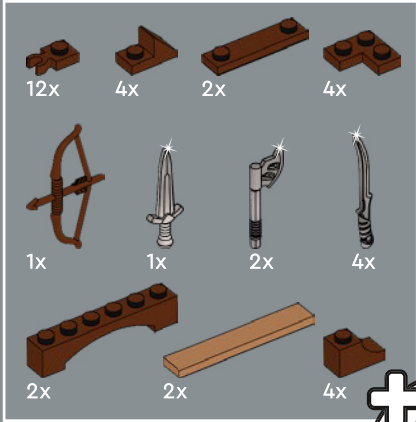
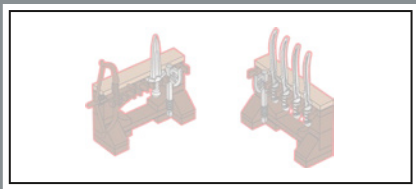

420

1

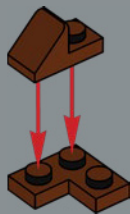

2

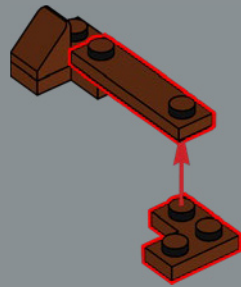

3

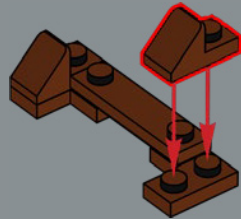

4

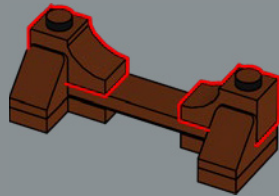

5

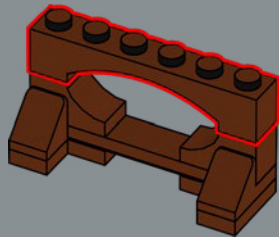

6

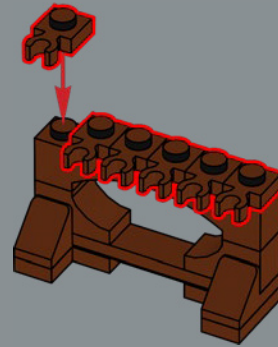

7

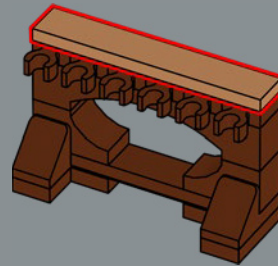

2x

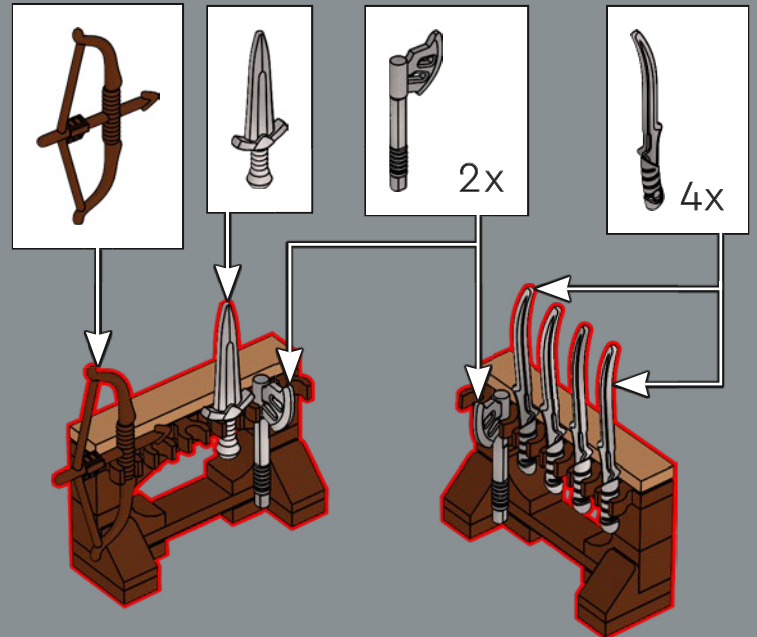



In diesen Regalen lassen sich all die Waffen lagern, die gerade nicht gebraucht werden. Die Regale passen wunderbar in die Waffenkammer an der Schmiede.



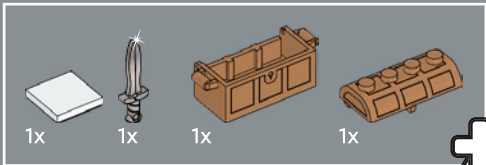

422

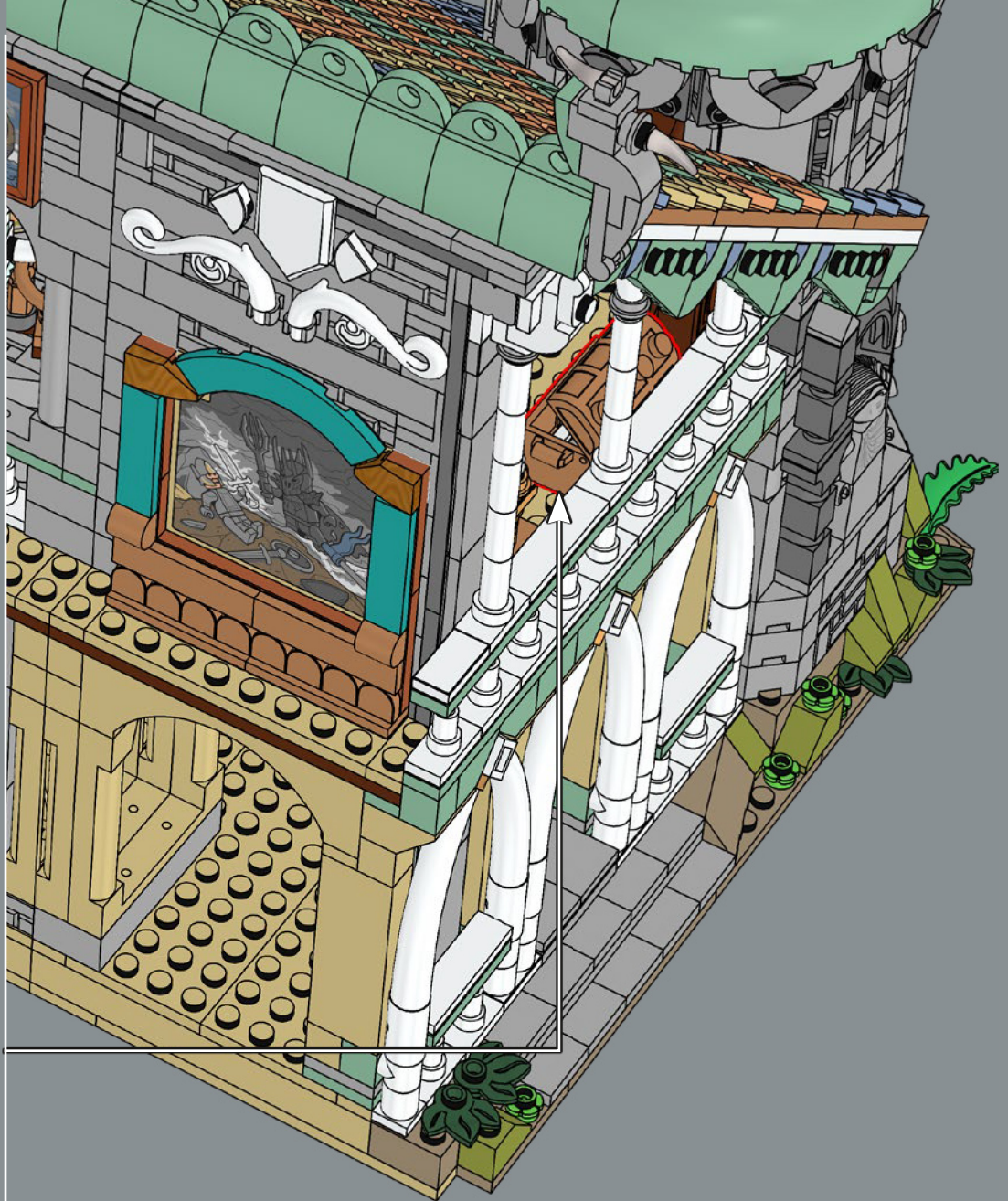
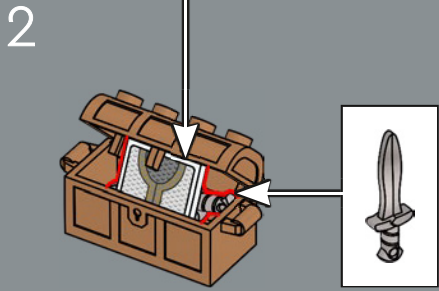
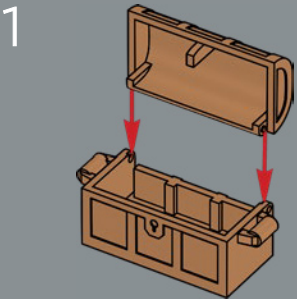
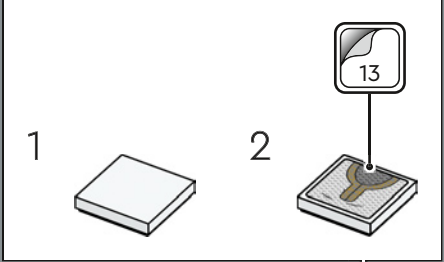
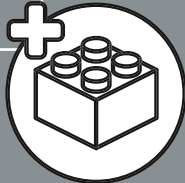

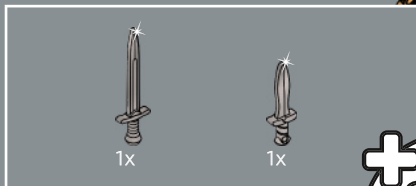

423

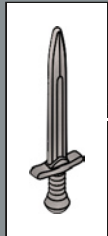
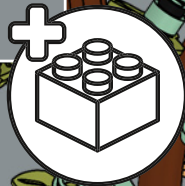

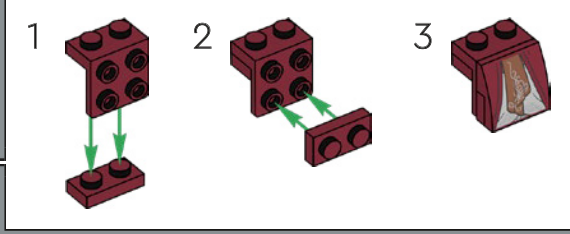
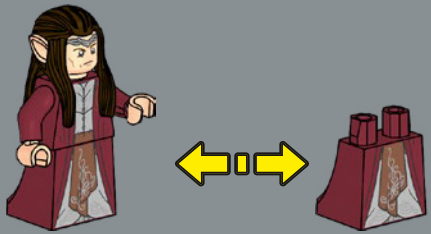
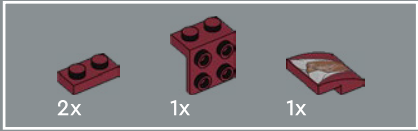
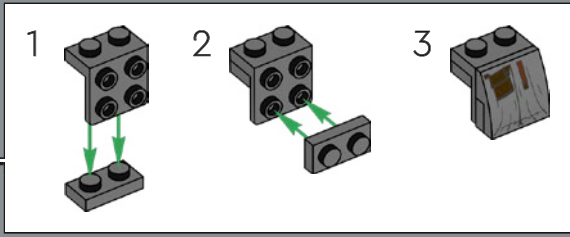
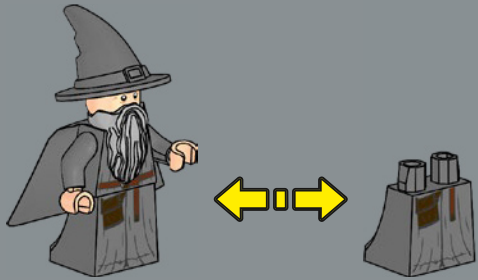
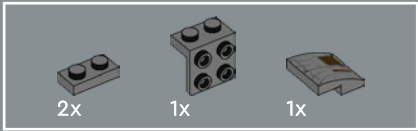
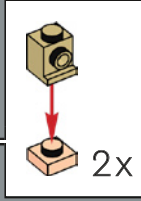
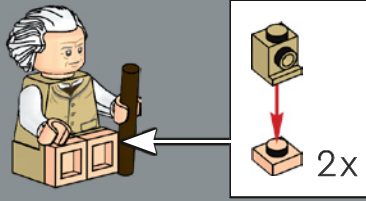
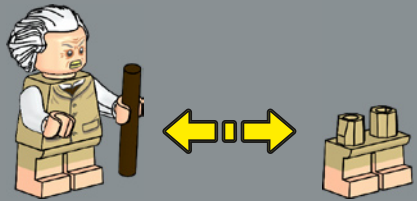
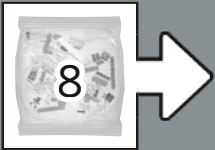
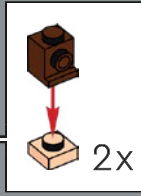
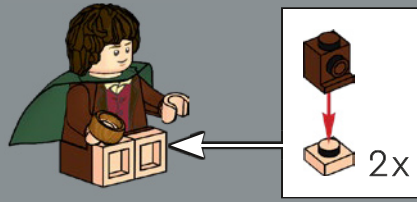
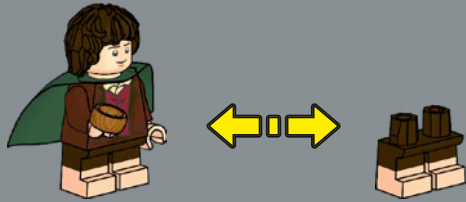
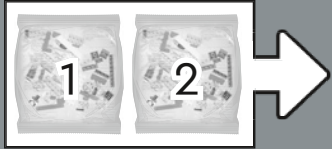
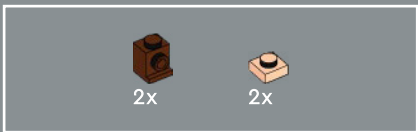





LEGO and the LEGO logo are trademarks of the LEGO Group. ©2023 The LEGO Group.

© 2023 New Line Productions, Inc. All rights reserved. The Lord of the Rings: The Fellowship of the Ring, The Lord of the Rings: The Two Towers, The Lord of the Rings: The Return of the King and the names of the characters, items, events and places therein are trademarks of The Saul Zaentz Company d/b/a Middle-earth Enterprises under license to New Line Productions, Inc. (s23)