



STAR WARS™

4206862

4488

MINI BUILDING SET



Millennium Falcon™

1/4



LEGO

**STAR
WARS™**

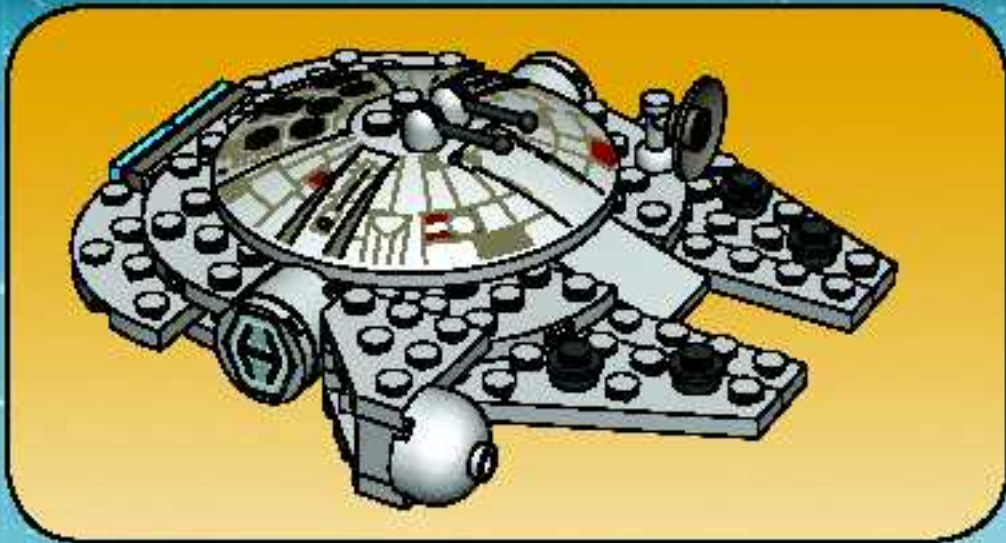

1

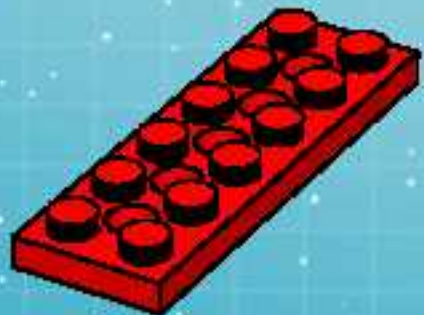

2

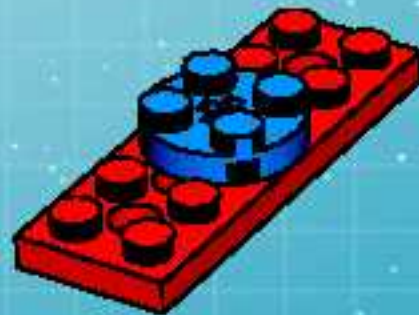

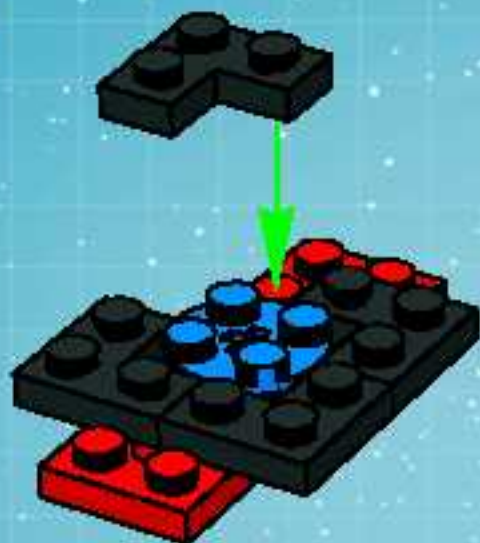

5

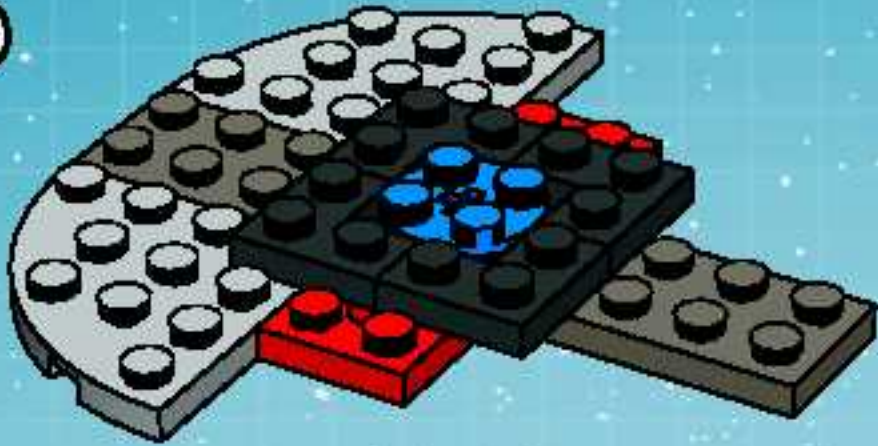

6

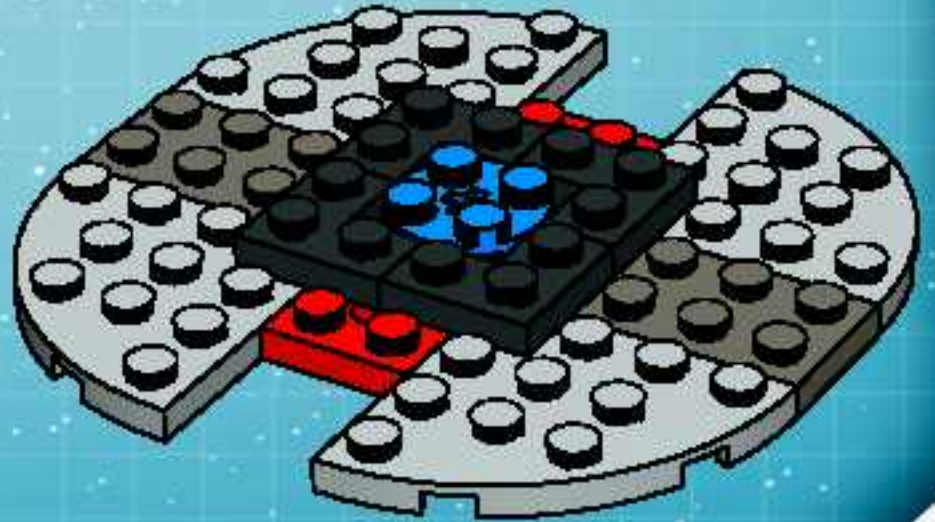

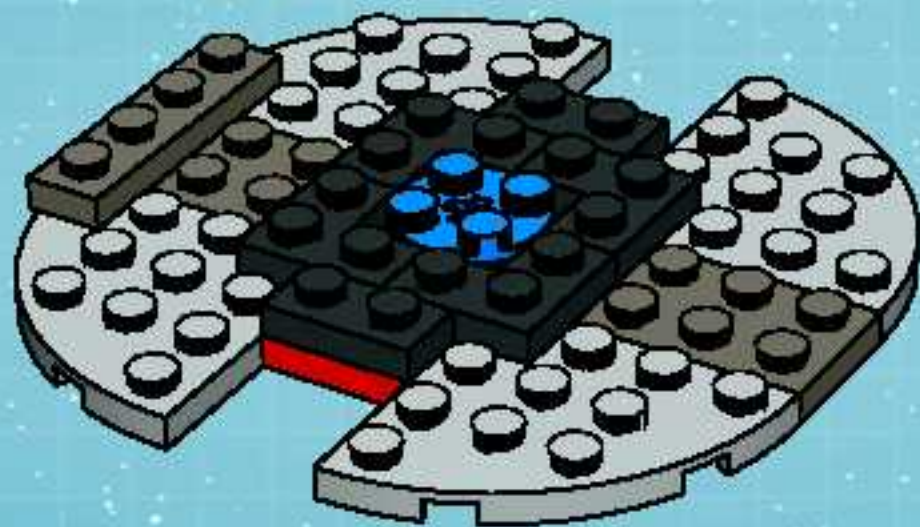

1

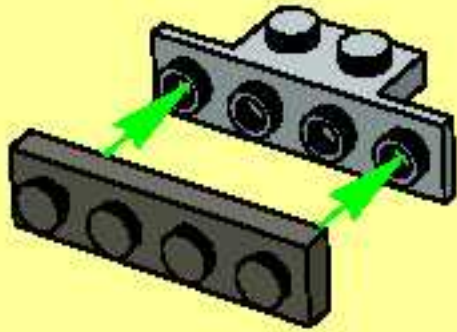

2

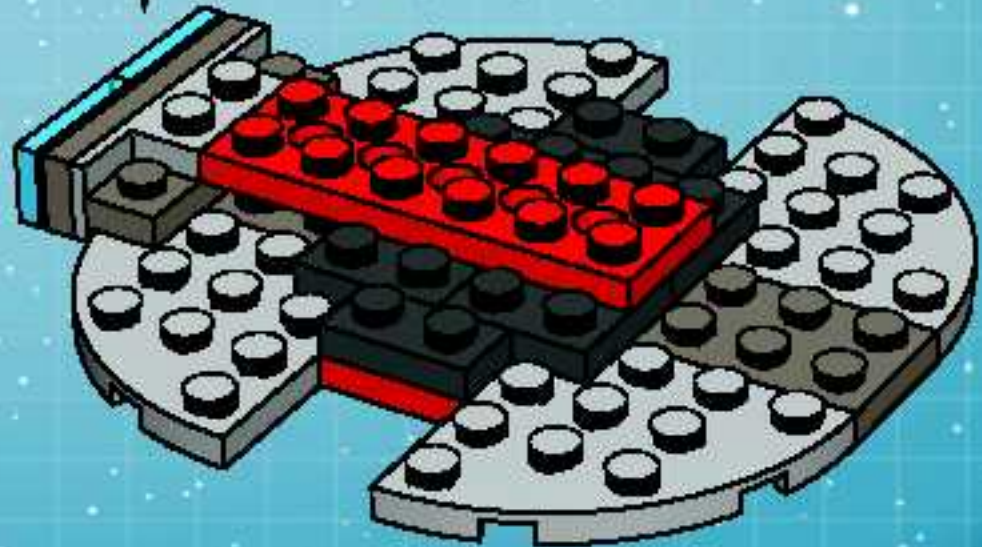
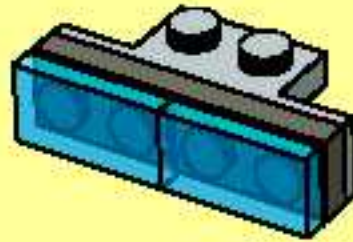

10

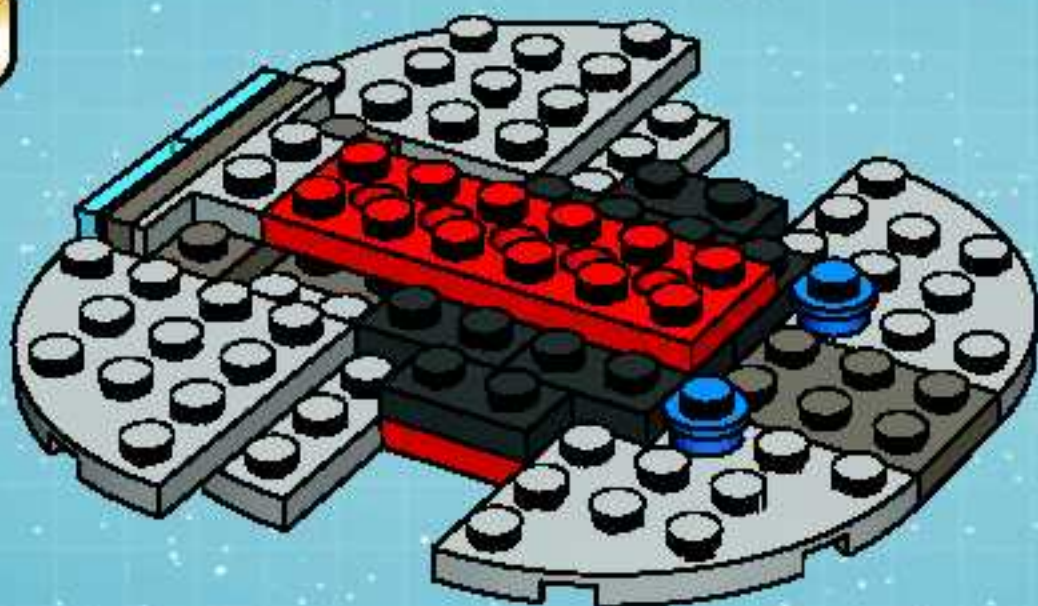

10

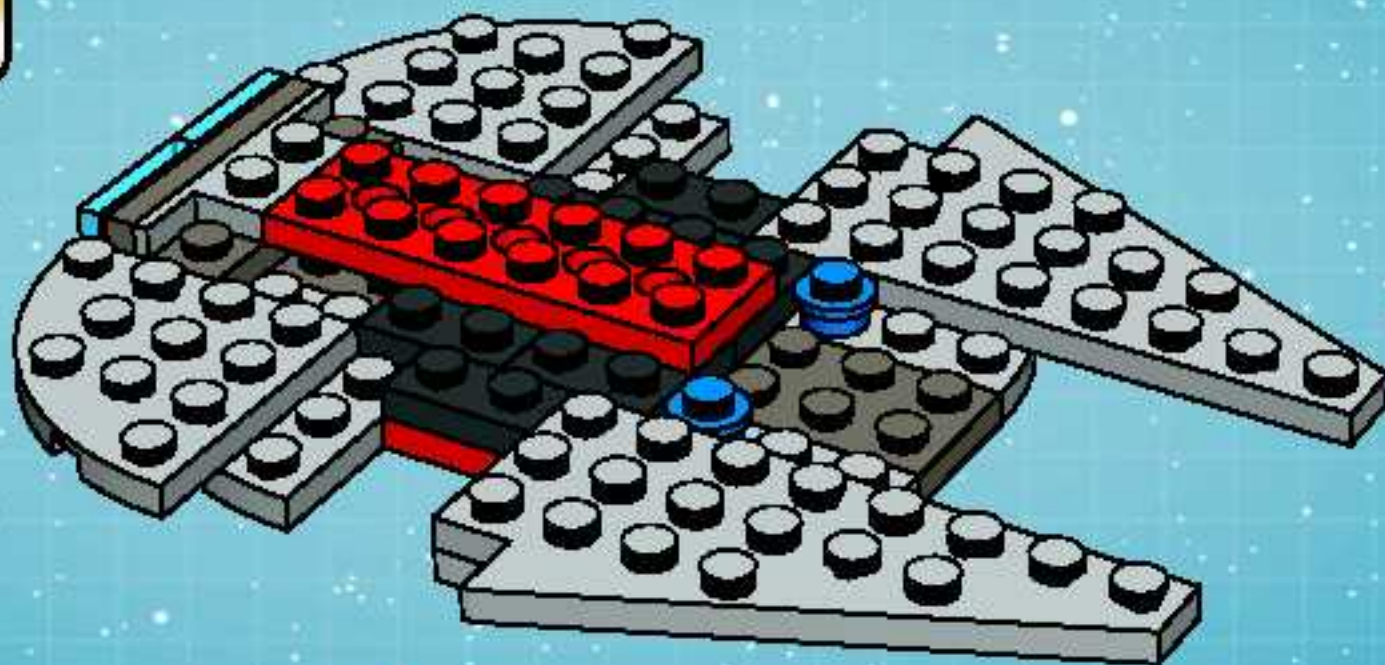

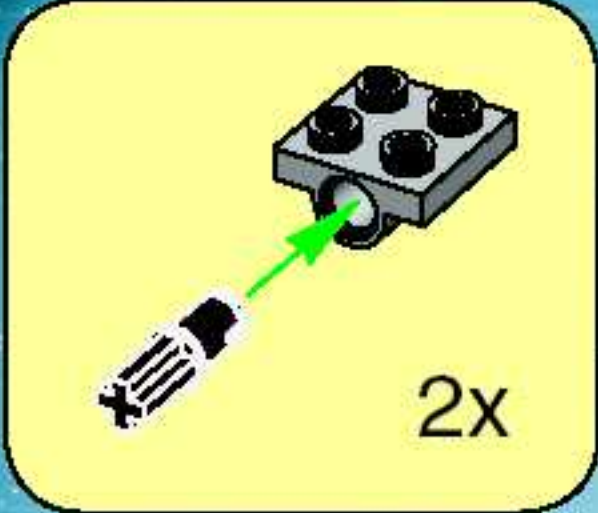

11

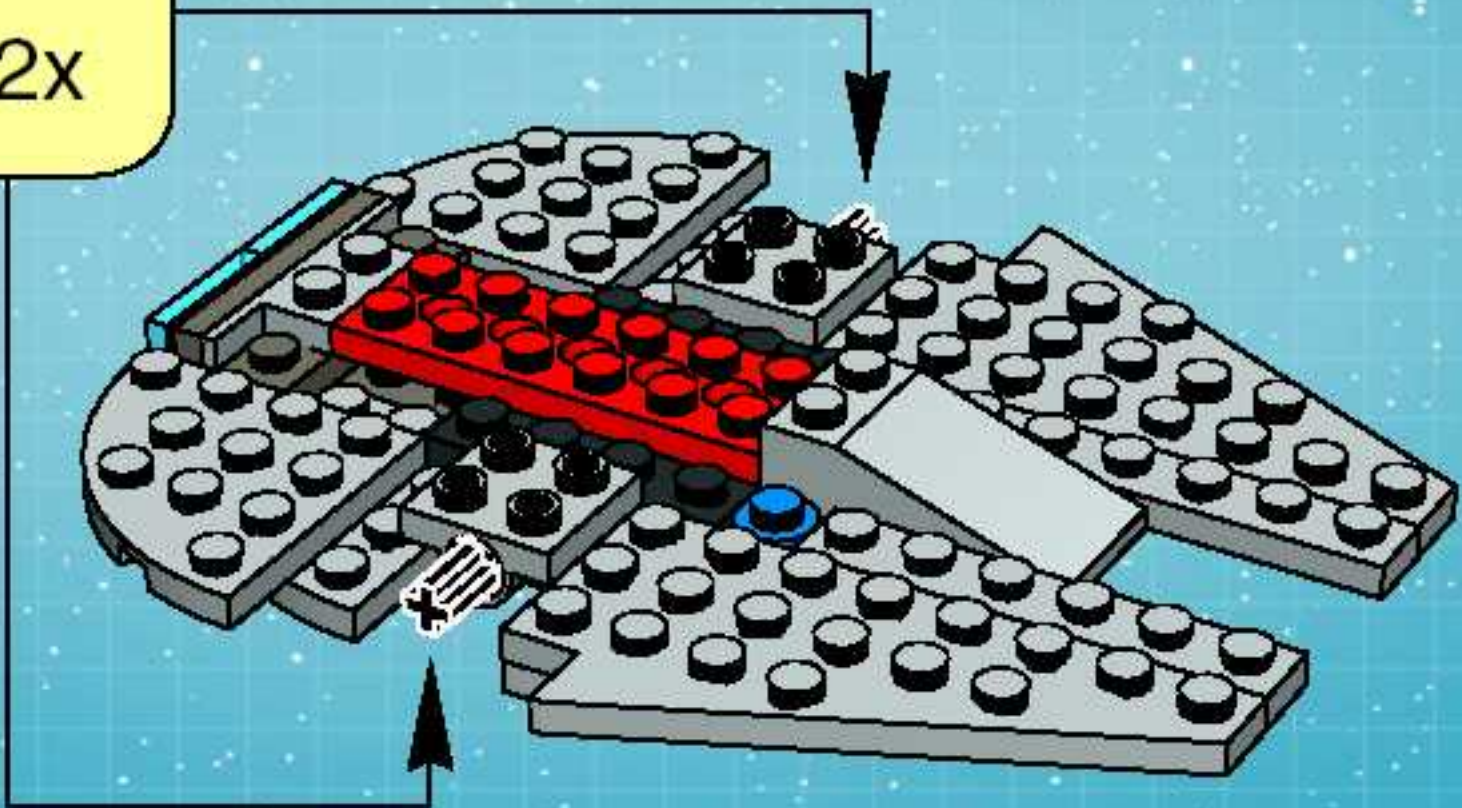

12



1B

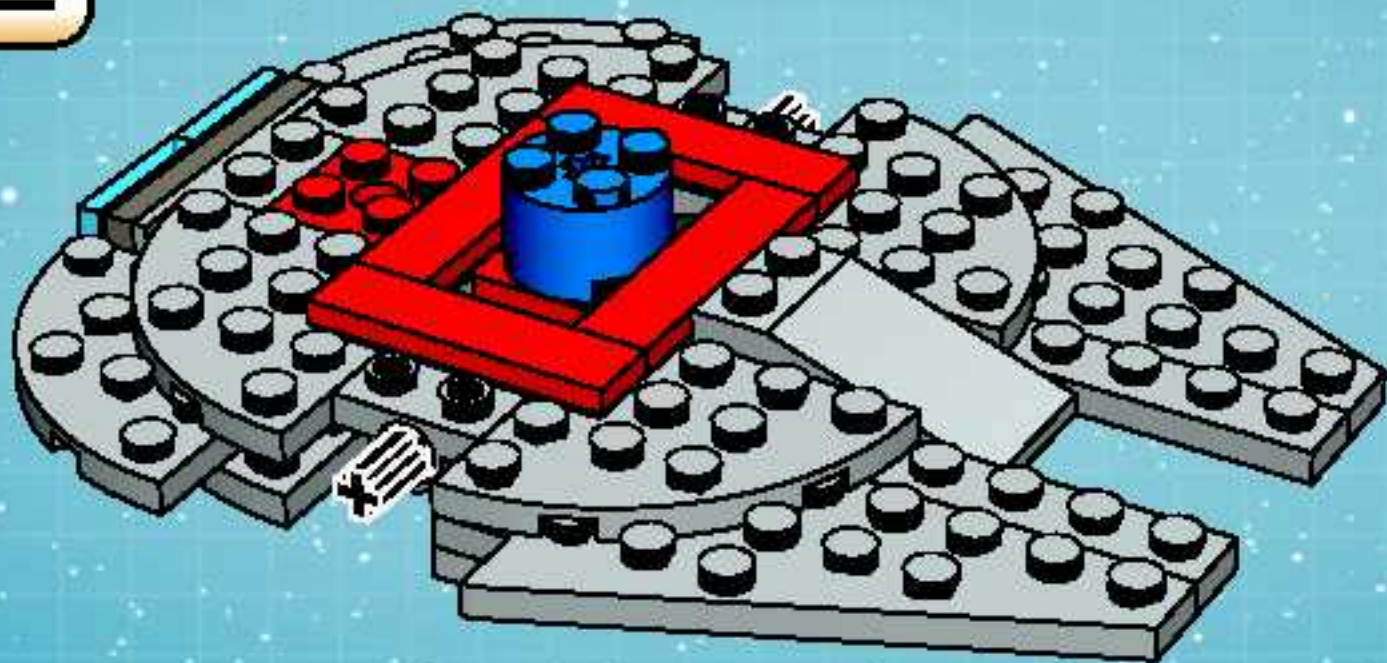



14

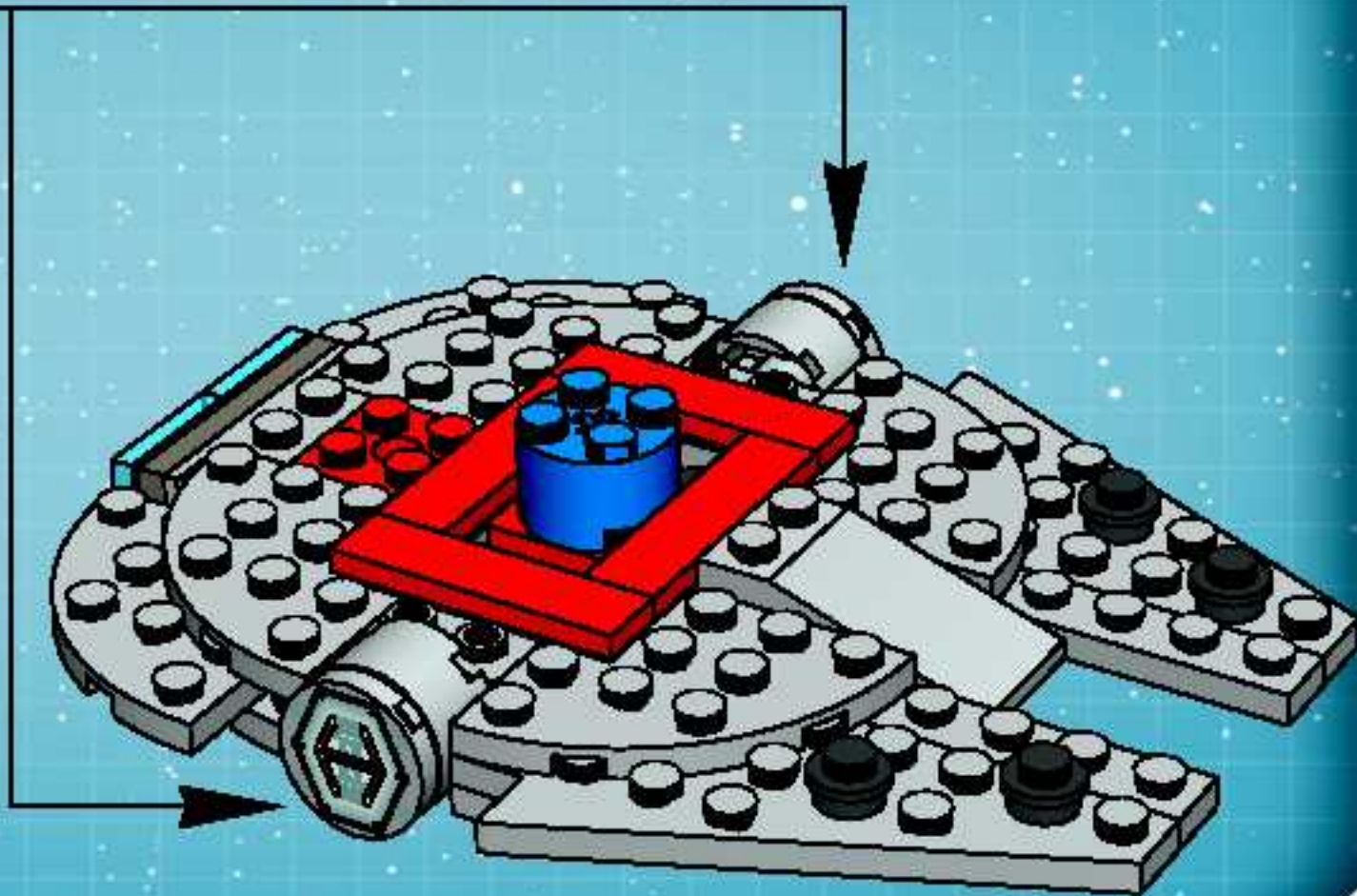

15

1



2

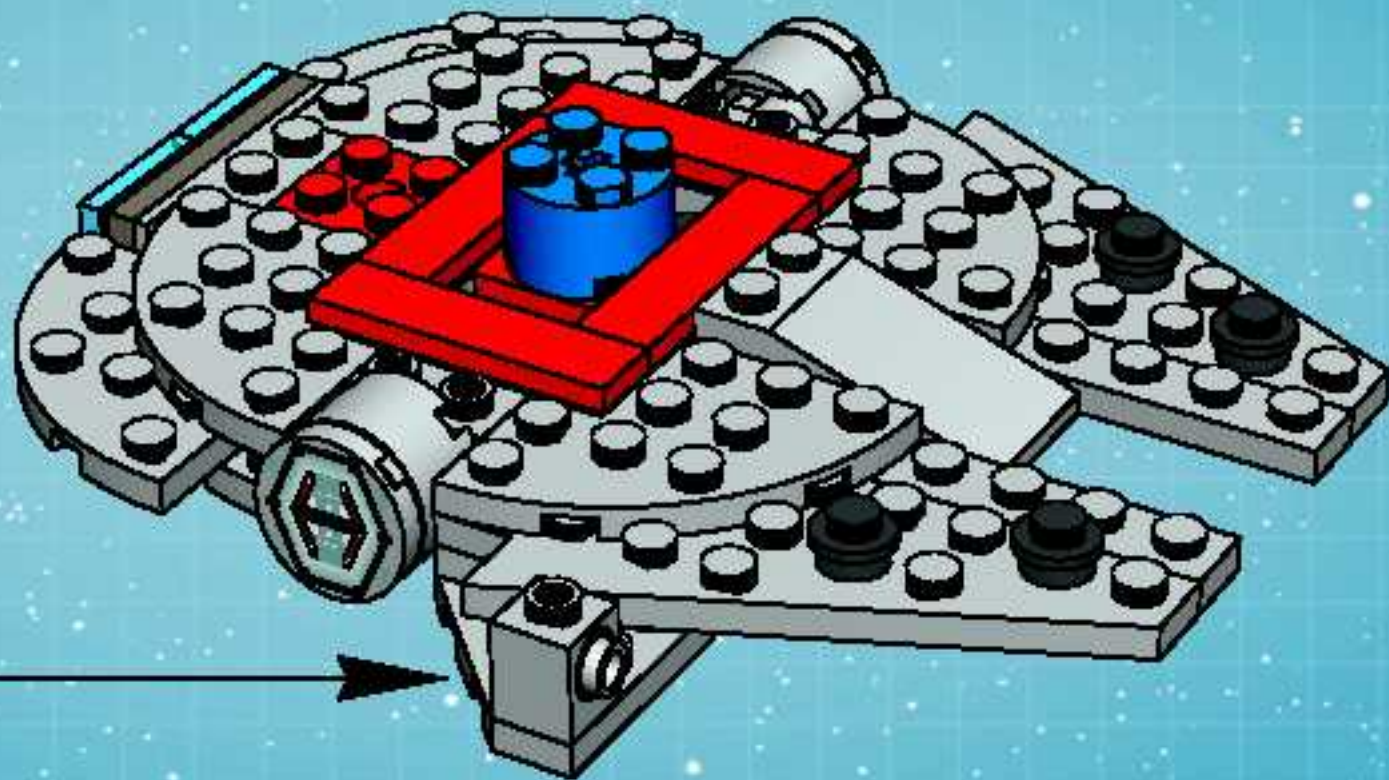
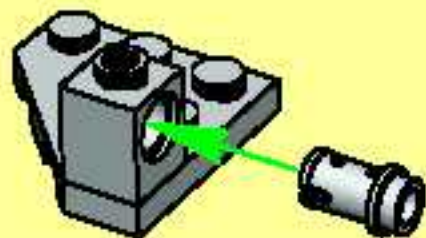

16

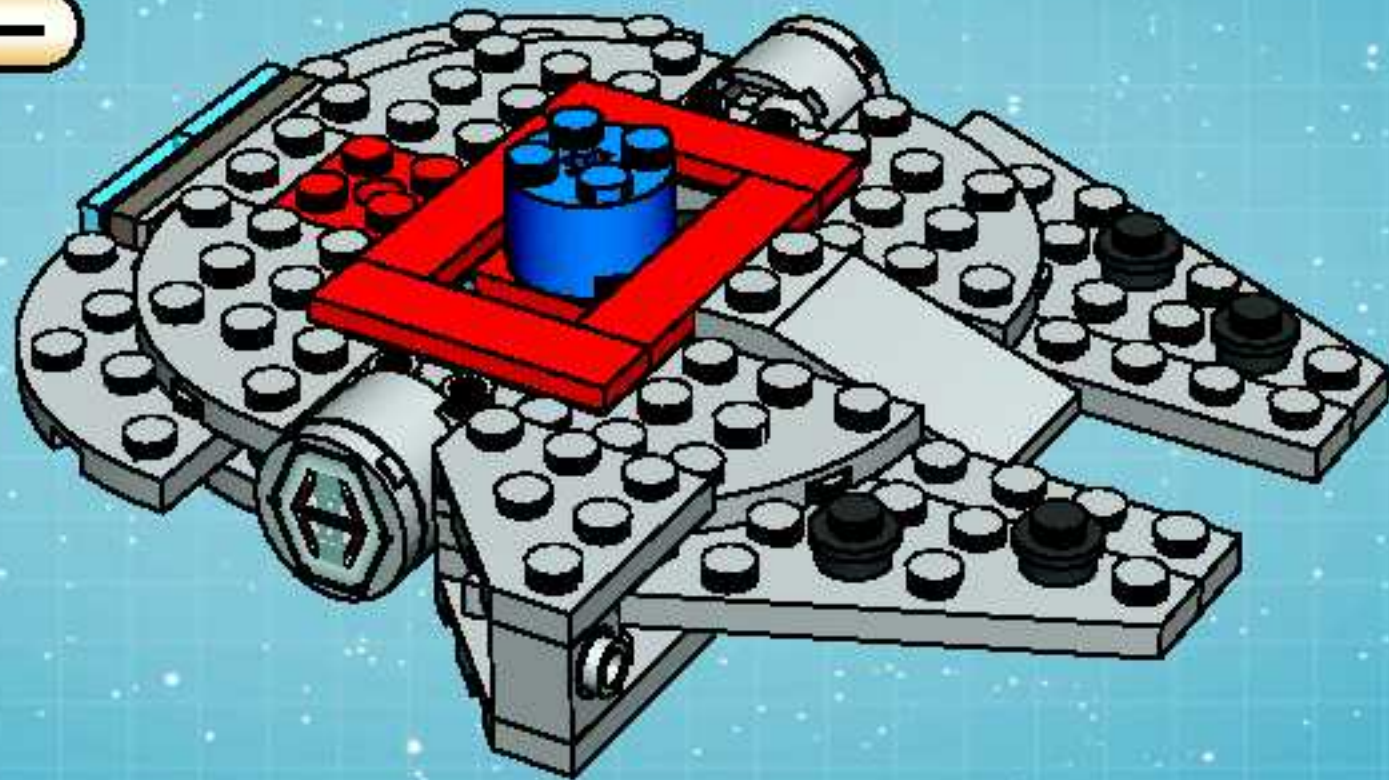

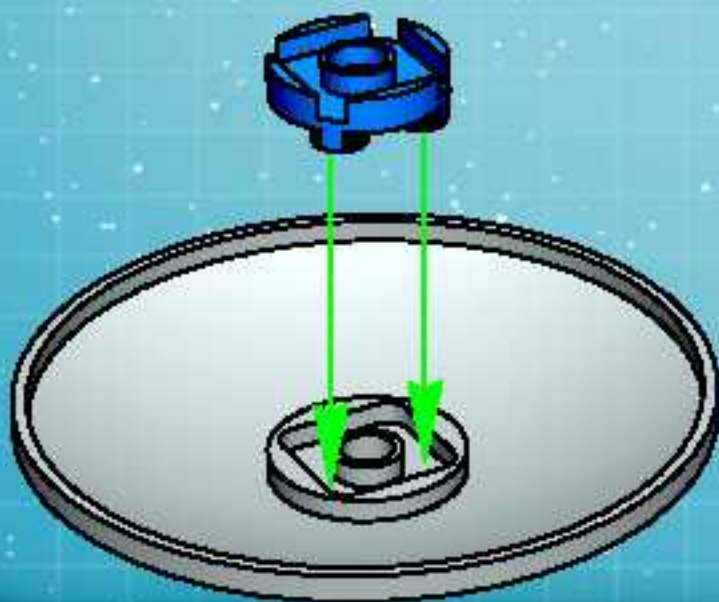
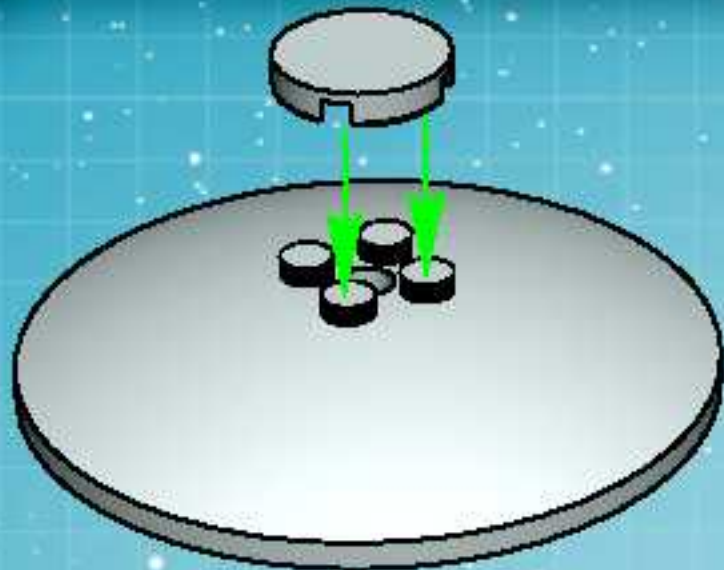

17

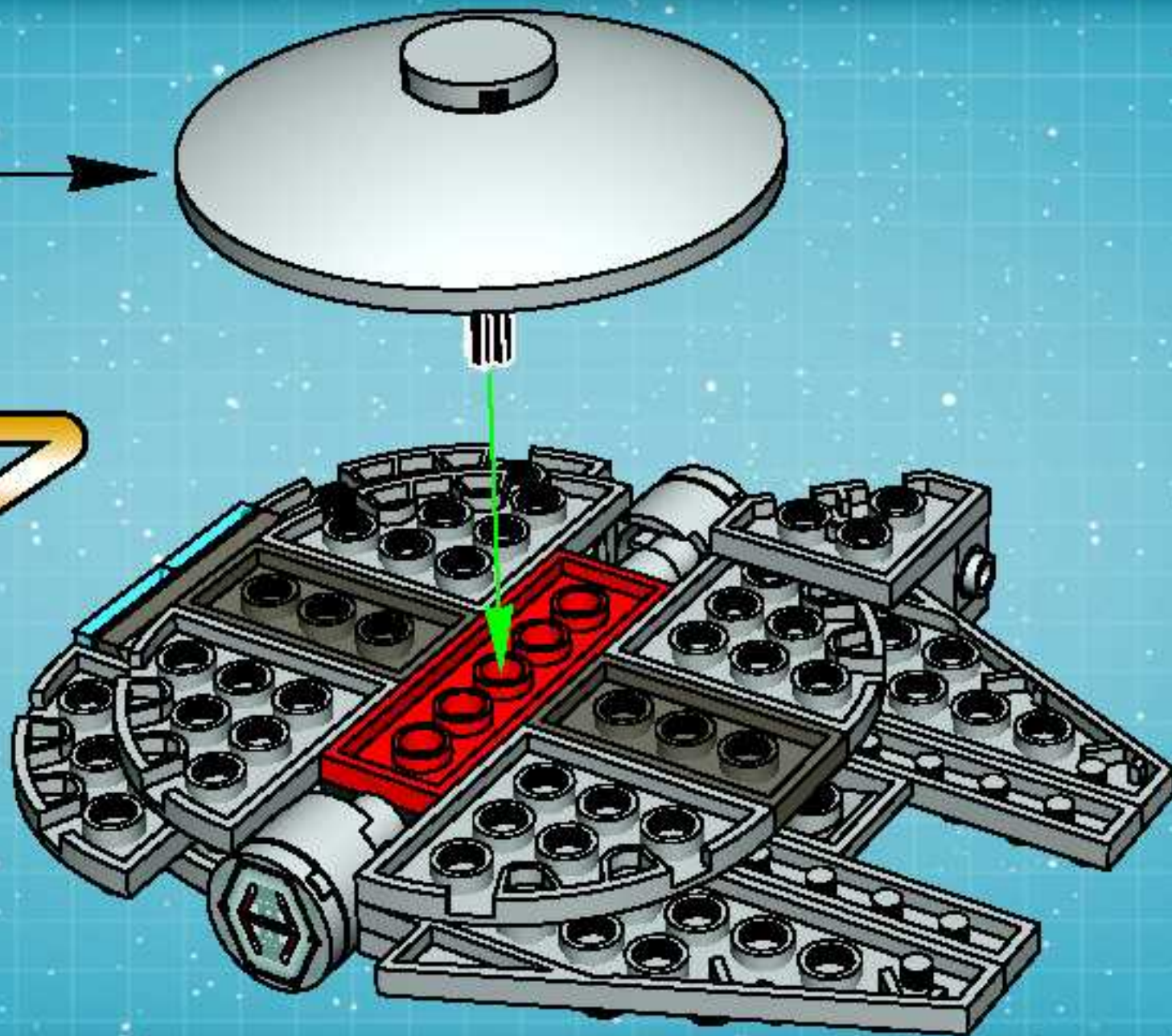

18



19

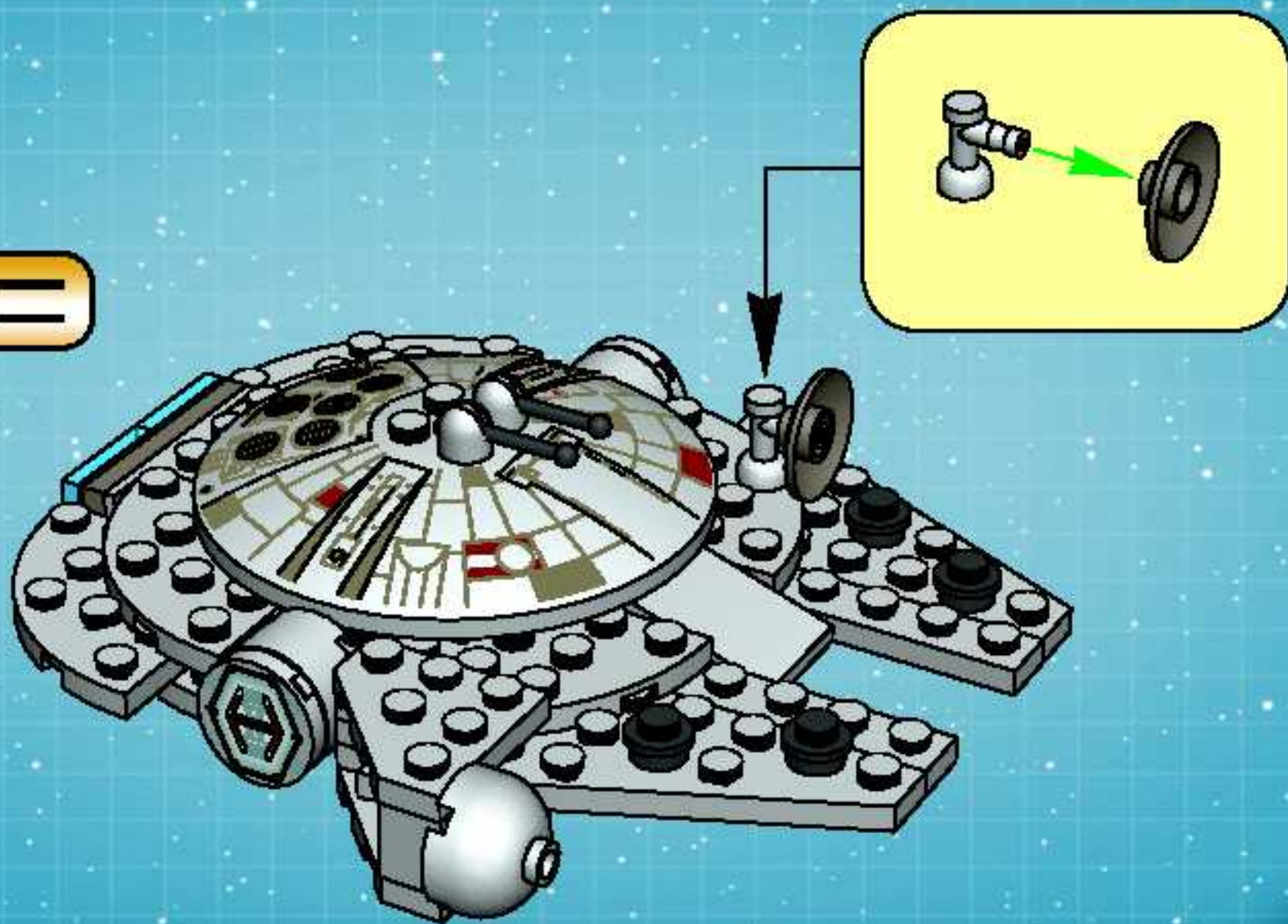



STAR WARS





1



2

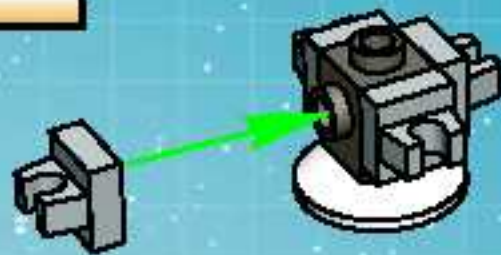

3



1



2

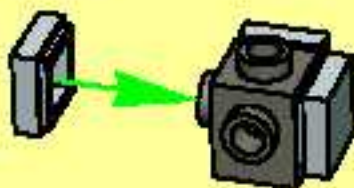

3



4

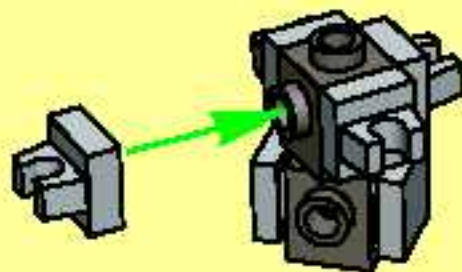

5

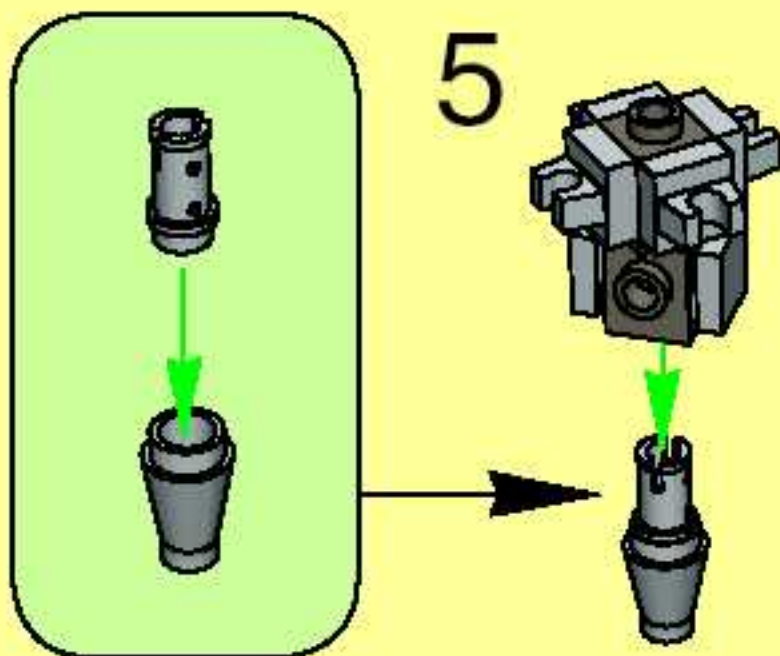

4



5

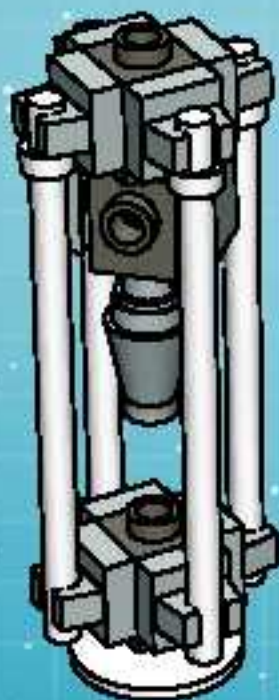

6



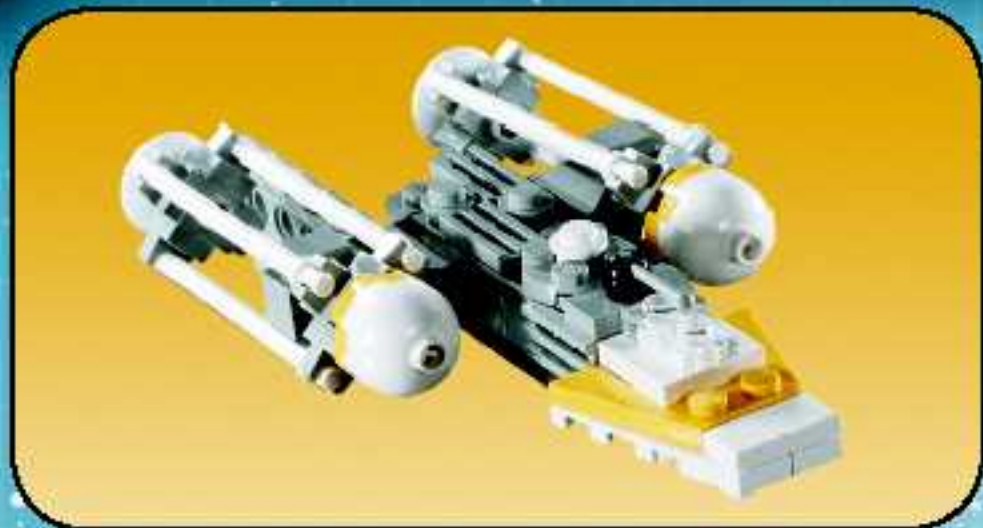

1



2

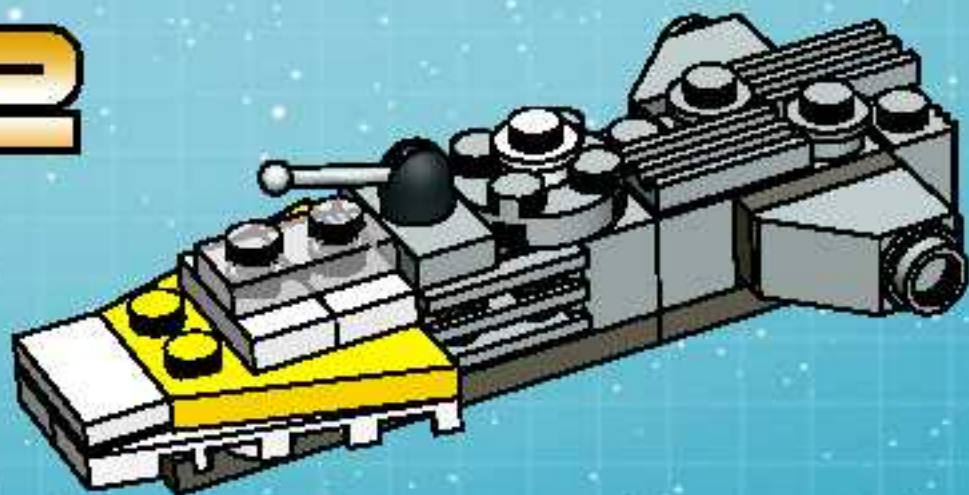

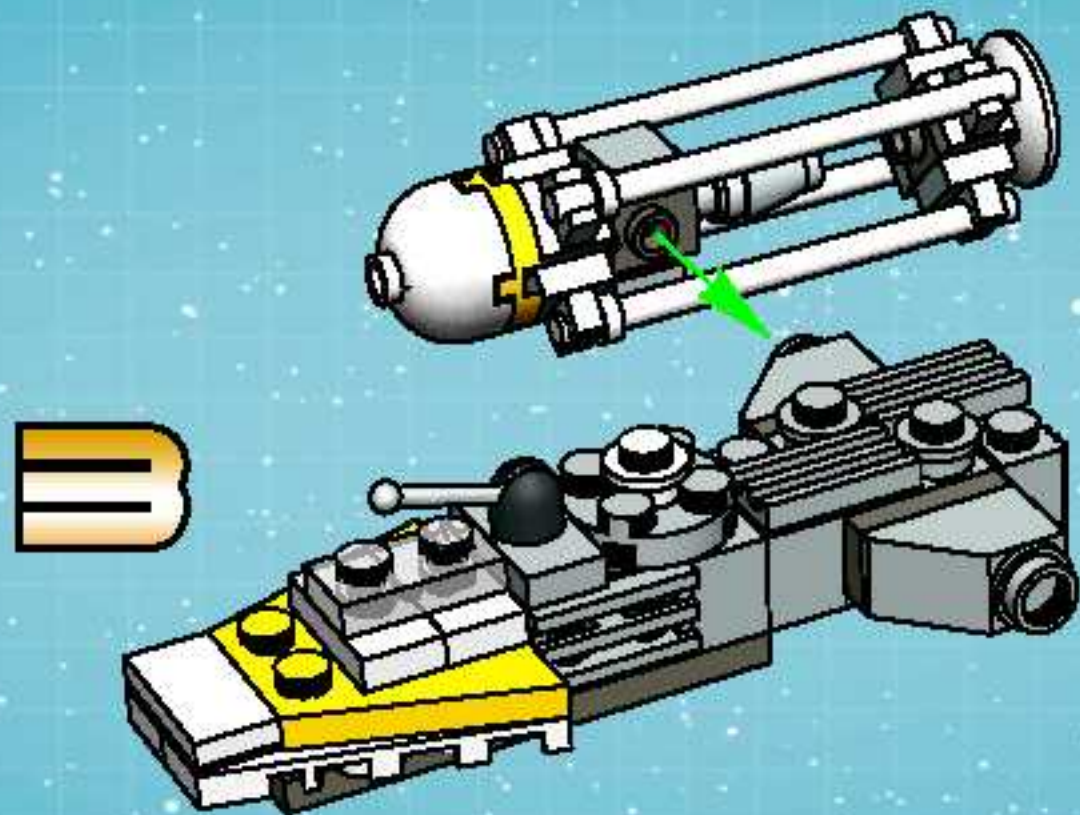

4

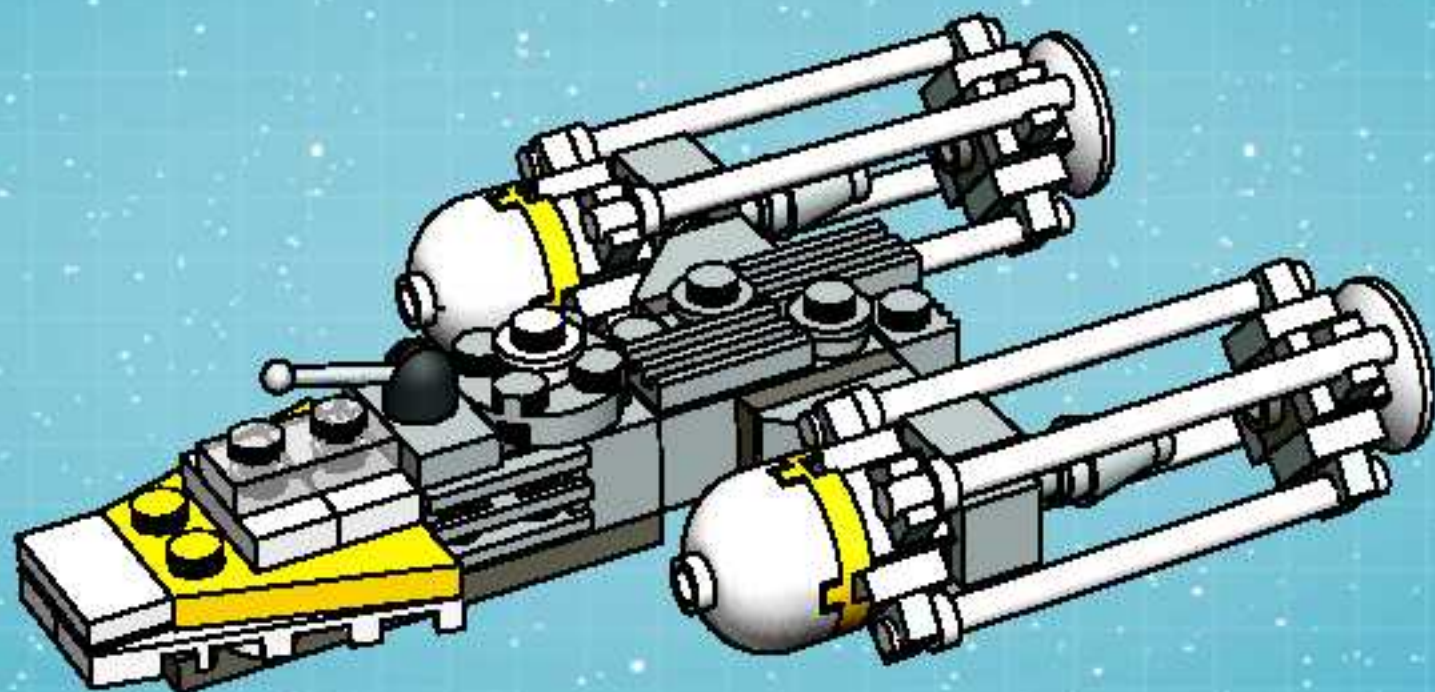

4479

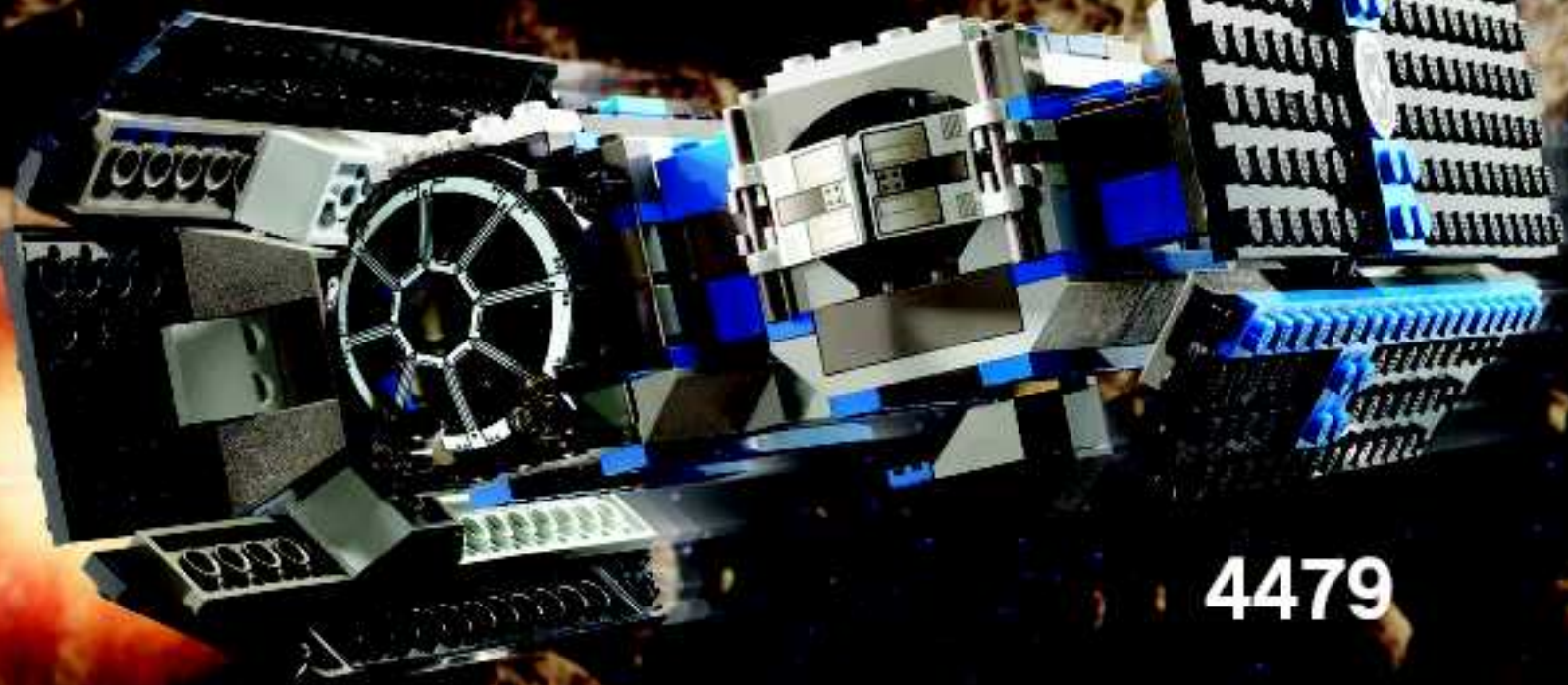

4479



LEGO, the LEGO logo and the minifigure are trademarks of the LEGO Group.
©2003 The LEGO Group.

© 2003 Lucasfilm Ltd. & TM/MC. All rights reserved. Used under authorization.